

7-212

~~SECRET~~
UNCLASSIFIED

(1)

DTIC FILE COPY

HANDBOOK OF

0021

BALLISTIC AND ENGINEERING DATA FOR AMMUNITION

AD-A955 369



Registered: *Unclassified*
By Authority of: *Int. Ind. Sec.*
(Officer)

dtd 10 Mar 59
By: *H. H. ...*
(Name of Officer)

HERALD B. ...
Security Officer
(Grade, Jrgp.)
Ballistic Research Laboratories

Date: *10 Mar 59*

VOLUME II

76-F-42 to 105-F-314 incl.

DTIC

ELECTE

OCT 28 1988

S *cy* D

JULY 1950

Classification cancelled or changed to:

EO 14501
15 Dec 11
H. H. ...

Approved for Public Release;
distribution is unlimited.

88 1024 009

BALLISTIC RESEARCH LABORATORIES

ABERDEEN PROVING GROUND, MD.

Best Available Copy

~~SECRET~~
UNCLASSIFIED

~~SECRET~~
UNCLASSIFIED

TABLE OF CONTENTS

VOLUME II - 76-1-42 TO 105-1-314 INCL.

	BRLH No.	Paragraph Nos.
Shell, HE, 76-mm, M42A1	76-1-42	1-12
Projectile, APC, 76-mm (3-inch), M62A1	76-1-62	1- 8
Shot, AP, 76-mm (3-inch), M79	76-1-79	1- 8
Shot, HVAP, 76-mm, M93	76-1-93	1- 8
Shell, HE, 81-mm, M43 and M43A1	81-1-43	1- 7
Shell, HE, 81-mm, M56	81-1-56	1- 9
Shell, Smoke, 81-mm, M57	81-1-57	1- 8
Shot, AP, 90-mm, T33	90-1-T33	1- 8
Shell, HE, 90-mm, M58 and M58B1	90-1-58	1- 8
Shell, HE, 90-mm, M71	90-1-71	1-13
Shot, AP, 90-mm, M77	90-1-77	1- 8
Projectile, APC, 90-mm, M82	90-1-82	1- 8
Shot, HVAP, 90-mm, M304	90-1-304	1- 8
Shell, HE, 105-mm, M1	105-1-1	1-12
Shell, HE, 105-mm, T12	105-1-T12	1- 6
Shell, HEAT, 105-mm, M67	105-1-67	1- 9
Shell, Illuminating, 105-mm, M314	105-1-314	1- 8

QUALITY
INSPECTED
4

Accession For	
NTIS CRA&I	<input checked="" type="checkbox"/>
DTIC TAB	<input type="checkbox"/>
Unannounced	<input type="checkbox"/>
Justification _____	
By _____	
Distribution/ _____	
Availability Codes	
Dist	Aval and/or Special
A-1	

UNCLASSIFIED

UNANNOUNCED

Ballistic Research Laboratories
Handbook of Ballistic and
Engineering Data for Ammunition,
No. 76-1-42

Ballistic Research Lab.
Aberdeen Proving Ground,
Maryland.
2 February 1949

BALLISTIC AND ENGINEERING DATA

for

Shell, HE, 76-mm, M42A1

with

Fuzes, PD, M48, M48A1, M48A2 and M51A4; TSQ,
M54 and M55A3; MT, M43A5; and CP, M78

<u>Section</u>		<u>Paragraphs</u>
I	General -----	1
II	Description -----	2 - 4
III	Interior ballistic data -----	5 - 6
IV	Exterior ballistic data -----	7 - 8
V	Effect data -----	9 - 12

SECTION I

GENERAL

	<u>Paragraph</u>
Purpose -----	1

1. Purpose. The purpose of this number of the handbook is to furnish a concise collection of information regarding the shape, dynamics, ballistics and effects of the 76-mm High Explosive Shell M42A1 with the Point Detonating Fuzes M48, M48A1, M48A2 and M51A4; the Time and Superquick Fuze M54; the Mechanical Time Fuze M43A5; and the Concrete Piercing Fuze M78. This information is collected from the drawings, reports, firing tables, and technical manuals pertaining to this ammunition.

**DIMENSIONS IN CALIBERS
1 CAL = 3.000"**

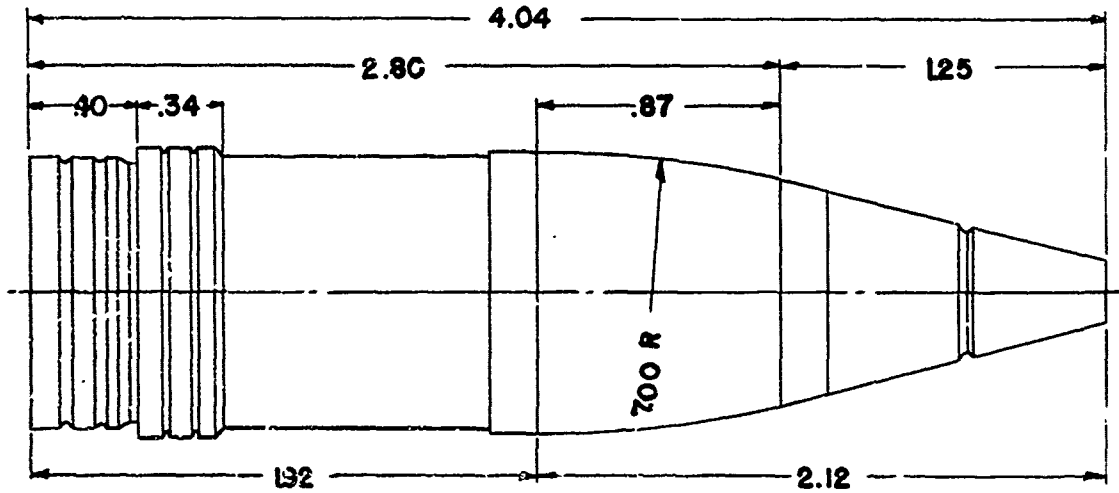

**SHELL, HE, 76-MM, M42A1
FUZE, PD, M48, M48A1, M48A2 OR M51A4;
T SQ, M54; OR MT, M43A5**

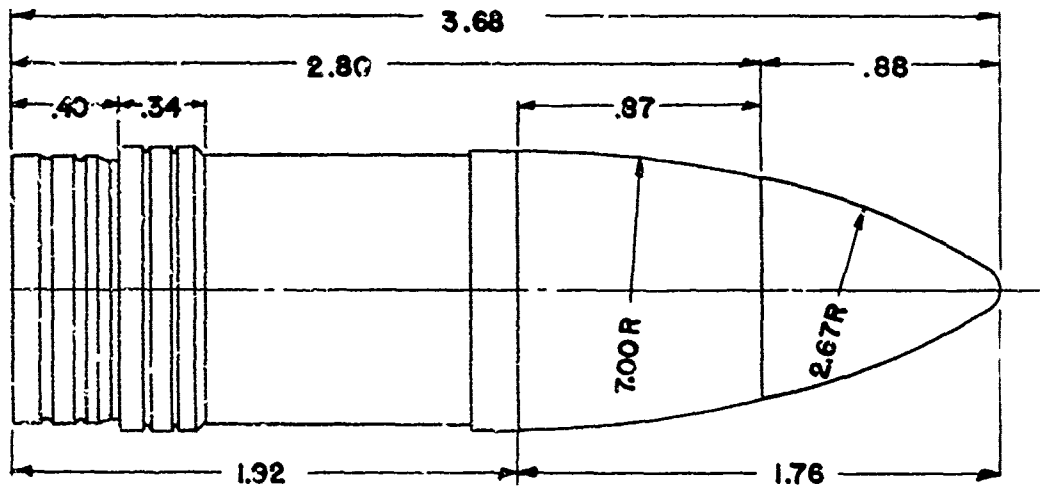

**SHELL, HE, 76-MM, M42A1
FUZE, CP, M78**

SECTION II
DESCRIPTION

	<u>Paragraph</u>
Drawings - - - - -	2
Dimensions - - - - -	3
Physical characteristics - - - - -	4

2. Drawings.

Shell, M42A1: Metal parts assembly and details	75-18-33
Shell, M42B1: Metal parts assembly and details	75-18-37
Shell, M42B2: Metal parts assembly and details	75-18-38
Booster, M20A1: Assembly and details	73-2-112
Booster, M21A4: Assembly	73-2-154
Fuze, PD, M48, M48A1 and M48A2: Assembly	73-2-140
Fuze, PD, M51A4: Assembly	73-2-145
Fuze, TSQ, M54: Assembly	73-3-154
Fuze, MT, M43A5: Assembly and details	73-7-29
Fuze, CP, M78: Assembly and details	73-2-214

Note: The MT, PD, and TSQ Fuzes require one of the boosters; but the CP Fuze contains their working parts. The TSQ Fuze M54 and the Booster M21A4 are components of the TSQ Fuze M55A3, dwg 73-3-155.

3. Dimensions.

Band: Width	0.34 cal
Distance from base	0.40 cal
Cylindrical body: Length	1.92 cal
Ogive: Length	0.87 cal
Radius of arc	7.90 cal
Shell, unfuzed: Length	2.80 cal
Fuze, PD, TSQ or MT:	
Outside length	1.25 cal
Shell and fuze	4.04 cal
Ogive and fuze	2.12 cal
Fuze, CP: Outside length	0.88 cal
Radius of ogival arc	2.67 cal
Shell and fuze	3.68 cal
Ogive and fuze	1.76 cal

4. **Physical characteristics.** The weight, location of center of gravity, and moments of inertia of the HE Shell M42A1 with any of the PD, TSCQ or MT Fuzes are approximately the same as those of the HE Shell M42 with the MT Fuze M43A2. The physical characteristics of the HE Shell M42A1 with the CP Fuze is approximately the same as those of the HE Shell M42B2 with the inert Fuze T105 Type 6.

Shell Fuze		M42 M43A2	M42B2 T105 Type 6
Mean weight:	Marking (Standard)	lb 12.80	13.14
	Marking	lb 13.00	13.34
	Marking	lb 13.20	13.54
Base to center of gravity	cal ²	1.540	1.546
Axial moment of inertia	lb.ft ²	0.1105	0.1096
Transverse moment of inertia	lb.ft ²	0.8092	0.8106

SECTION III
INTERIOR BALLISTIC DATA

	<u>Paragraph</u>
Stresses - - - - -	5
Theoretical yaw in bore - - - - -	6

5. **Stresses.** The following table and the graphical representation on page 5 show the longitudinal, radial and tangential resultant stresses at each of three sections: (A) the rear corner of the band seat, (B) the front of the band seat, and (C) immediately behind the bourrelet.

Gun	76-mm M1A2
Twist of rifling	1/32
Cross-sectional area of bore	7.2776 sq in.
Rated maximum pressure	43,000 psi
Total weight of projectile	12.80 lb
Muzzle Velocity	2,700 fps
Density of filler (TNT)	0.057 lb per cu in.

<u>Resultant Stress*</u> 100 psi	<u>Section</u>		
	A	B	C
Longitudinal	- 274	-736	-355
Radial	+ 630	+ 87	+ 59
Tangential	-1086	+480	+212

* + denotes tension, - denotes compression

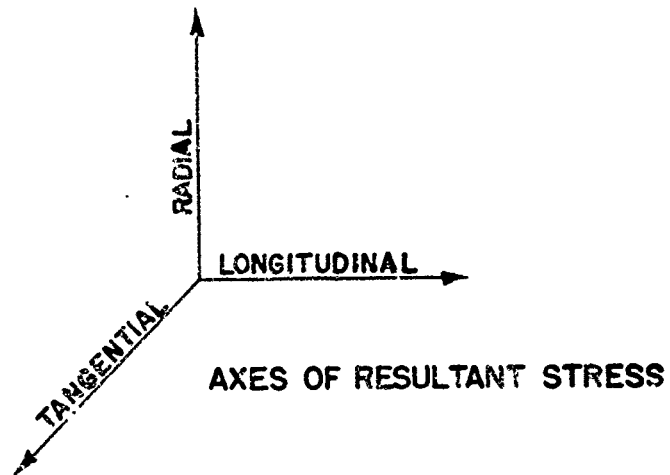
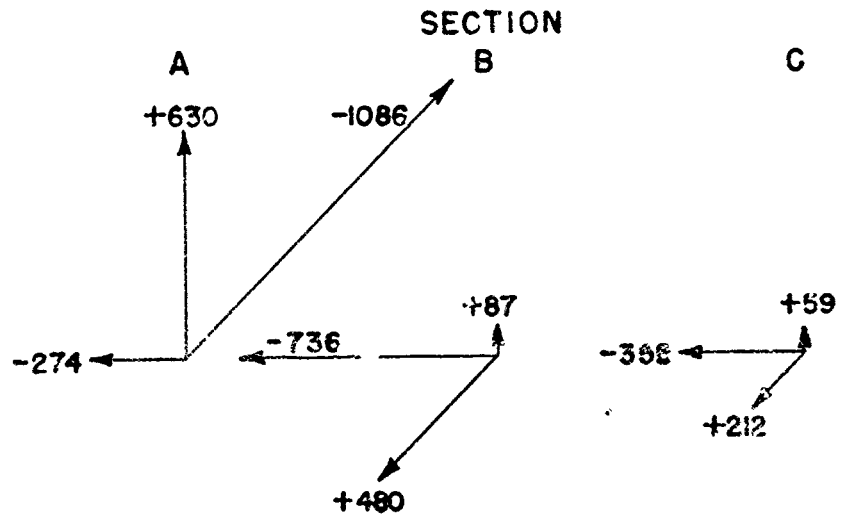
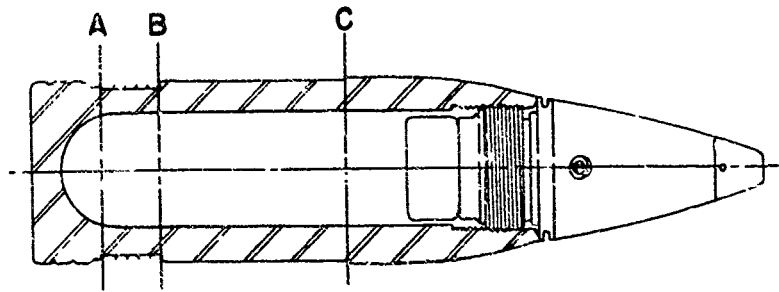

DIAGRAM OF RESULTANT STRESSES

6. Theoretical yaw in bore.

Minimum	7 min
Maximum	12 min

**SECTION IV
EXTERIOR BALLISTIC DATA**

	<u>Paragraph</u>
Aerodynamic data - - - - -	7
Firing table data - - - - -	8

7. Aerodynamic data. The aerodynamic data obtained with any of the PD, TSQ and MT Fuzes are applicable to all of them. The aerodynamic data obtained with the inert Fuze T105 Type 6 are applicable to the CP Fuze M78. The form factor given in this paragraph for the PD Fuze M48 was determined from resistance and range firings of the HE Shell M42 with the PD Fuze M48 and the MT Fuze M43A2. BRL Report No. 30, "Stability Factors of Projectiles" (Rev. Sep 1940) gives the stability factors and moment coefficients that were determined for the HE Shell M42 with the MT Fuze M43. BRL Report No. 298, "Stability and Resistance of 3-inch HE Shell M42A1 with PD Fuze T105 Type 6", gives the form factor and stability factor that were obtained in developing the CP Fuze. BRL Report No. 408, "Loss of Spin and Skin Friction Drag of Projectiles", gives the axial couple coefficient obtained from firings of the HE Shell M42 with a radio spin sonde in a dummy fuze having the same shape as the MT Fuze M43A2.

a. Drag.

Shell		M42	M42A1
Fuze		M48	T105 Type 6
Drag function		G_3	G_6
Muzzle Velocity	fps	2,700	2,680
Form factor		1.04	1.37
Ballistic coefficient		1.368	1.068
Drag coefficient, K_D		0.123	0.163

b. Stability.

Shell		M42	M42A1
Fuze		M43	T105 Type 6
Muzzle Velocity	fps	2800	2600
Mach number		2.50	2.39
Moment coefficient, K_M		<u>0.991</u>	<u>0.794</u>
Twist of rifling		1/32 1/40	1/32 1/40
Stability factor		2.03 1.30	2.45 1.57

c. Axial couple.

Shell	M42
Fuze	Radio sonde
Average velocity	1800 fps
Reynolds' number (based on avg vel. and caliber)	2.75×10^6
Axial couple coefficient, K_A	0.00585
Surface (without base)	96.5 sq in
Skin friction drag coefficient, C_{DF}'	0.00218

8. Firing table data. FT 76-C-1

FT 76-A-6 (Range-elevation tables and Aiming Data charts).

Gun, 76-mm, M1A2 on Medium Tank M4 or Gun Motor Carriage M18.

Twist of rifling: 1/32.

OCM item 18656 standardized the HE Shell M42A1 for the 76-mm Gun M1. OCM item 25455 authorized the use of a reduced charge to give a muzzle velocity of approximately 1550 fps; the normal charge gives about 2700 fps. The 76-mm Guns M1 and M1A1, whose twist of rifling is 1/40, are now obsolete. FT 3-W-1 gives data for the 3-inch Gun M5, whose twist of rifling is 1/40, firing the HE Shell M42A1 at muzzle velocities of 1550 and 2800 fps.

aFORM - FACTOR - ELEVATION CURVES
(PROJ TYPE 6)

<u>FUZE</u>	<u>CHARGE</u>	<u>MV-FPS</u>	<u>CURVE</u>
PD OR T. SQ	NORMAL	2700	1
	REDUCED	1550	2
CP	NORMAL	2680	3
	REDUCED	1539	4

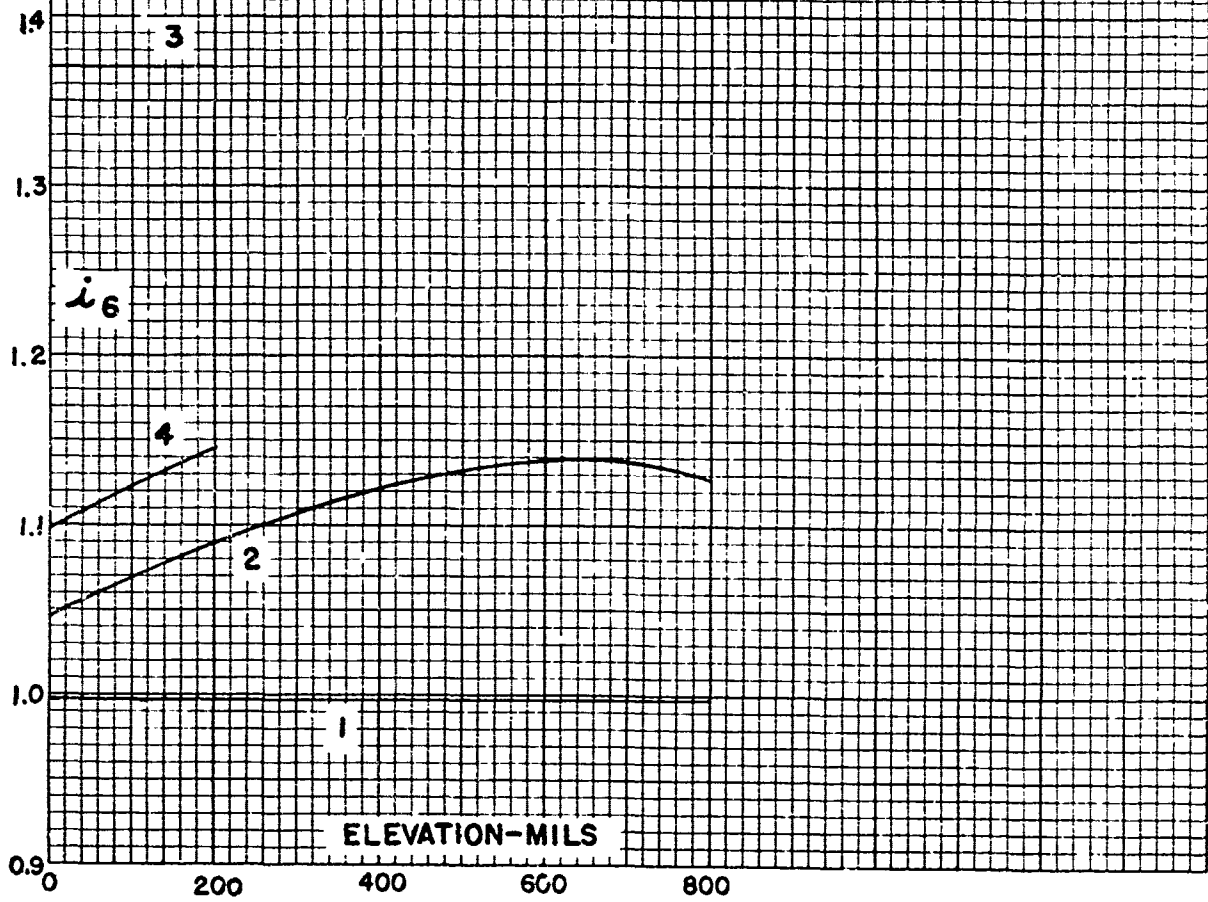

**b. BALLISTIC COEFFICIENT - ELEVATION CURVES
(PROJ TYPE 6)**

<u>FUZE</u>	<u>CHARGE</u>	<u>MV - FPS</u>	<u>CURVE</u>
PD OR T. SQ	NORMAL	2700	1
	REDUCED	1550	2
CP	NORMAL	2680	3
	REDUCED	1539	4

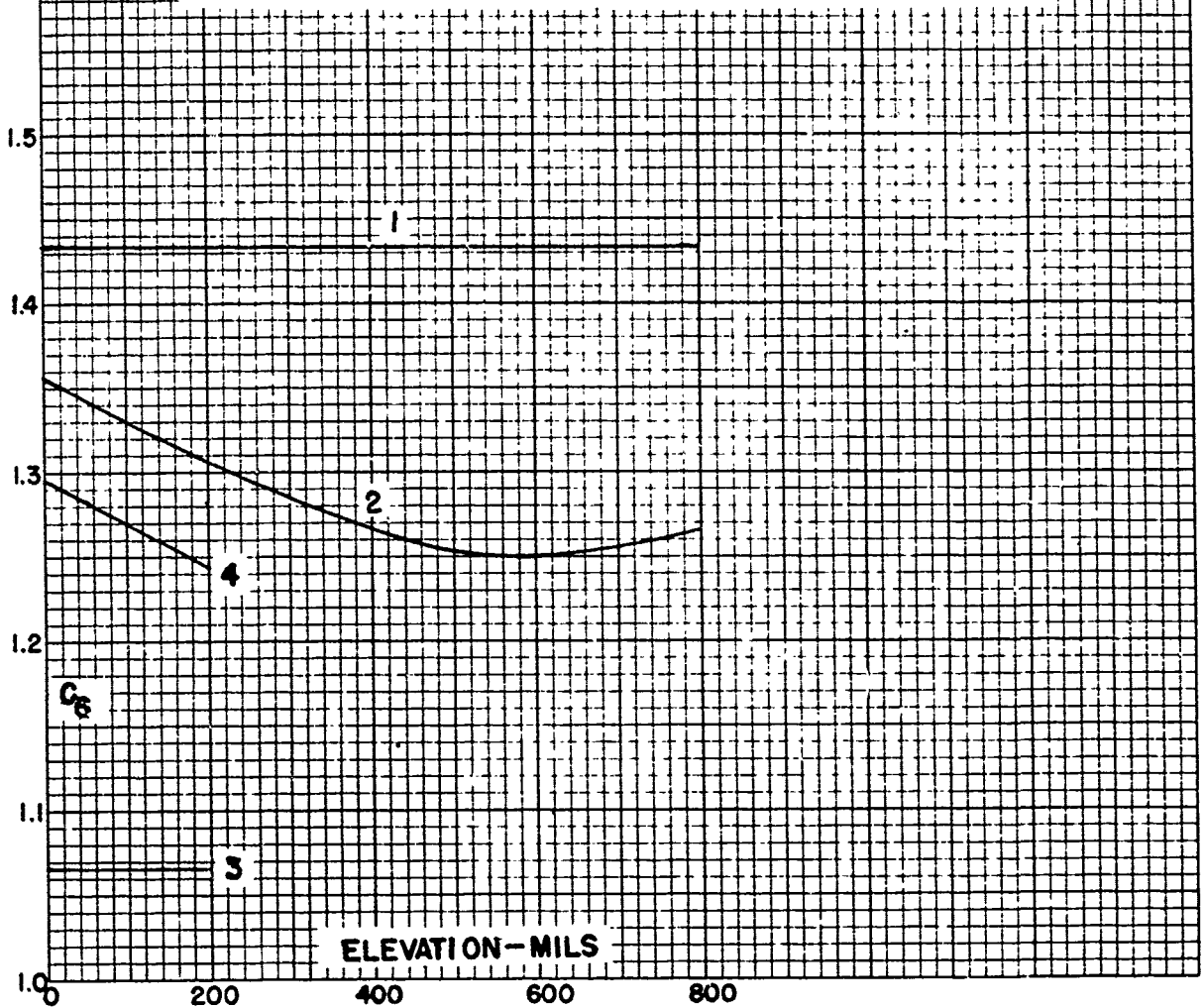

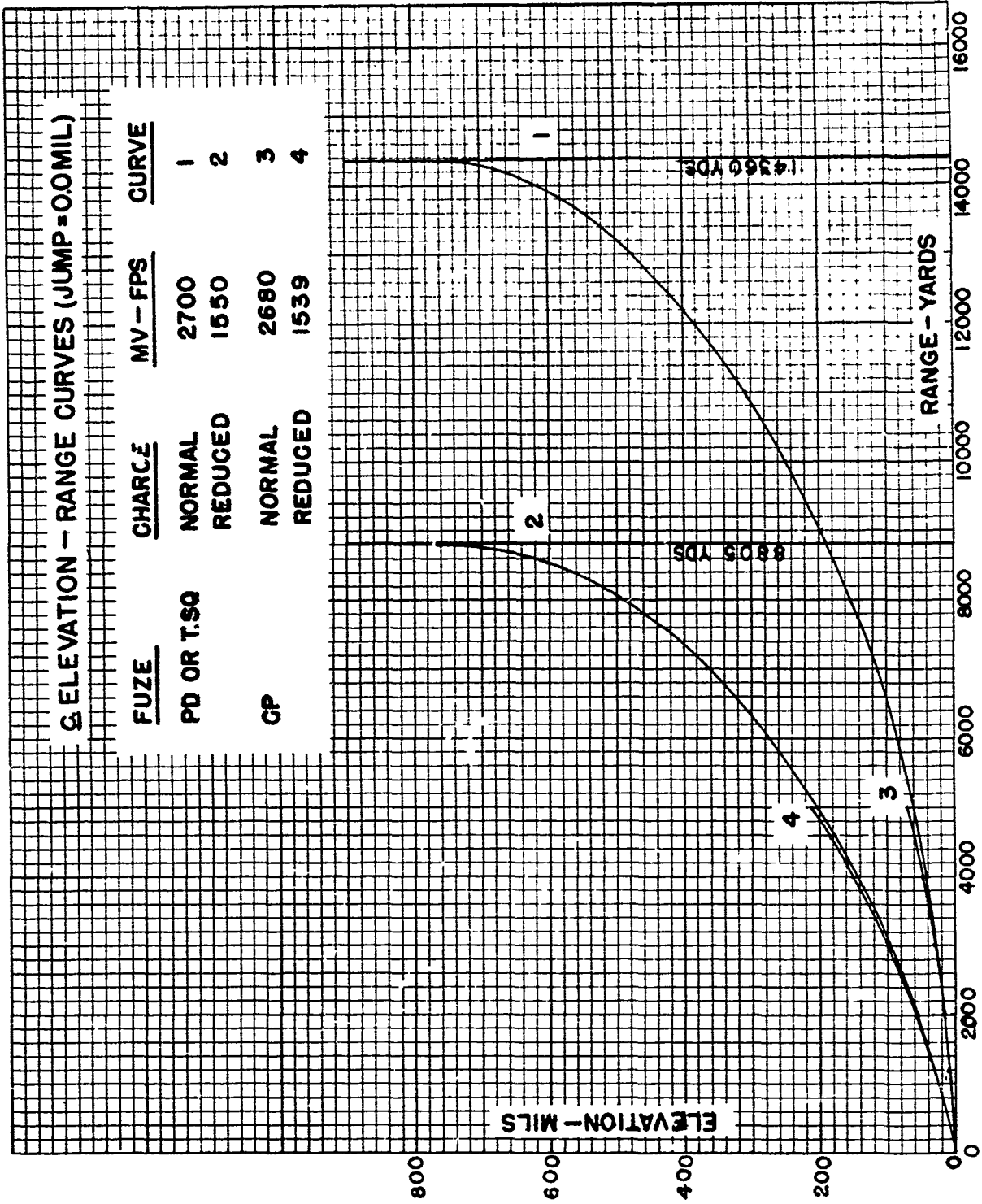

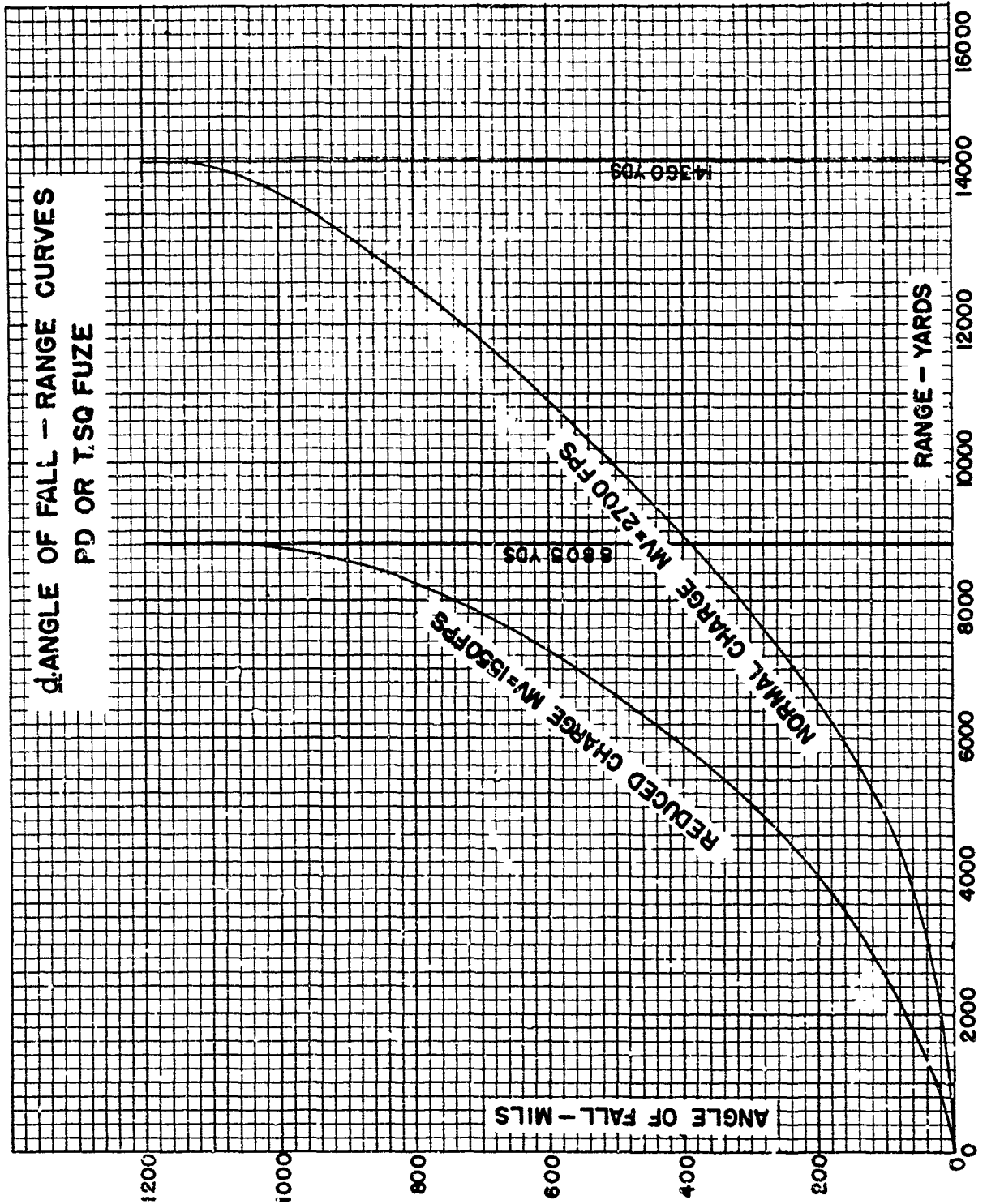

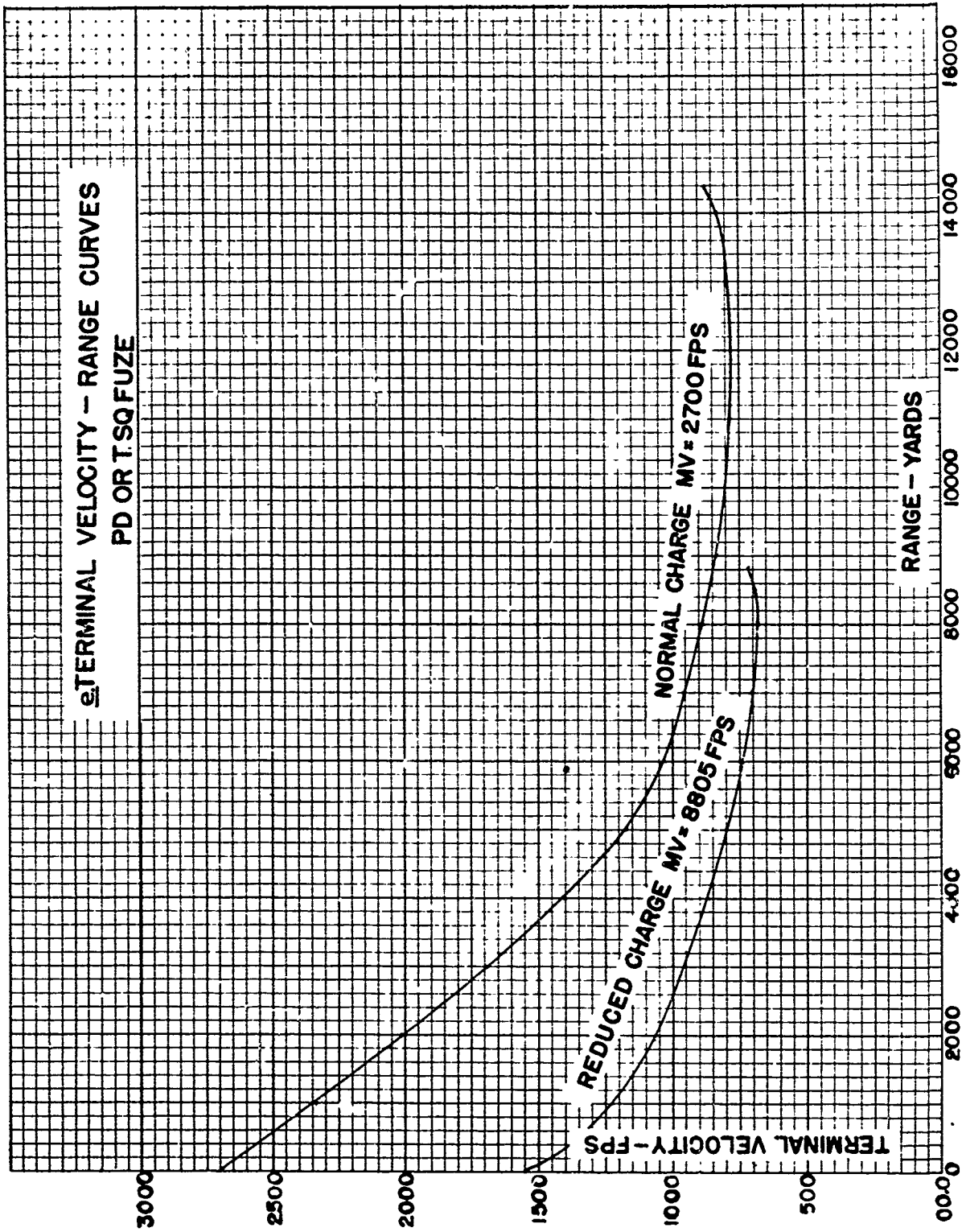

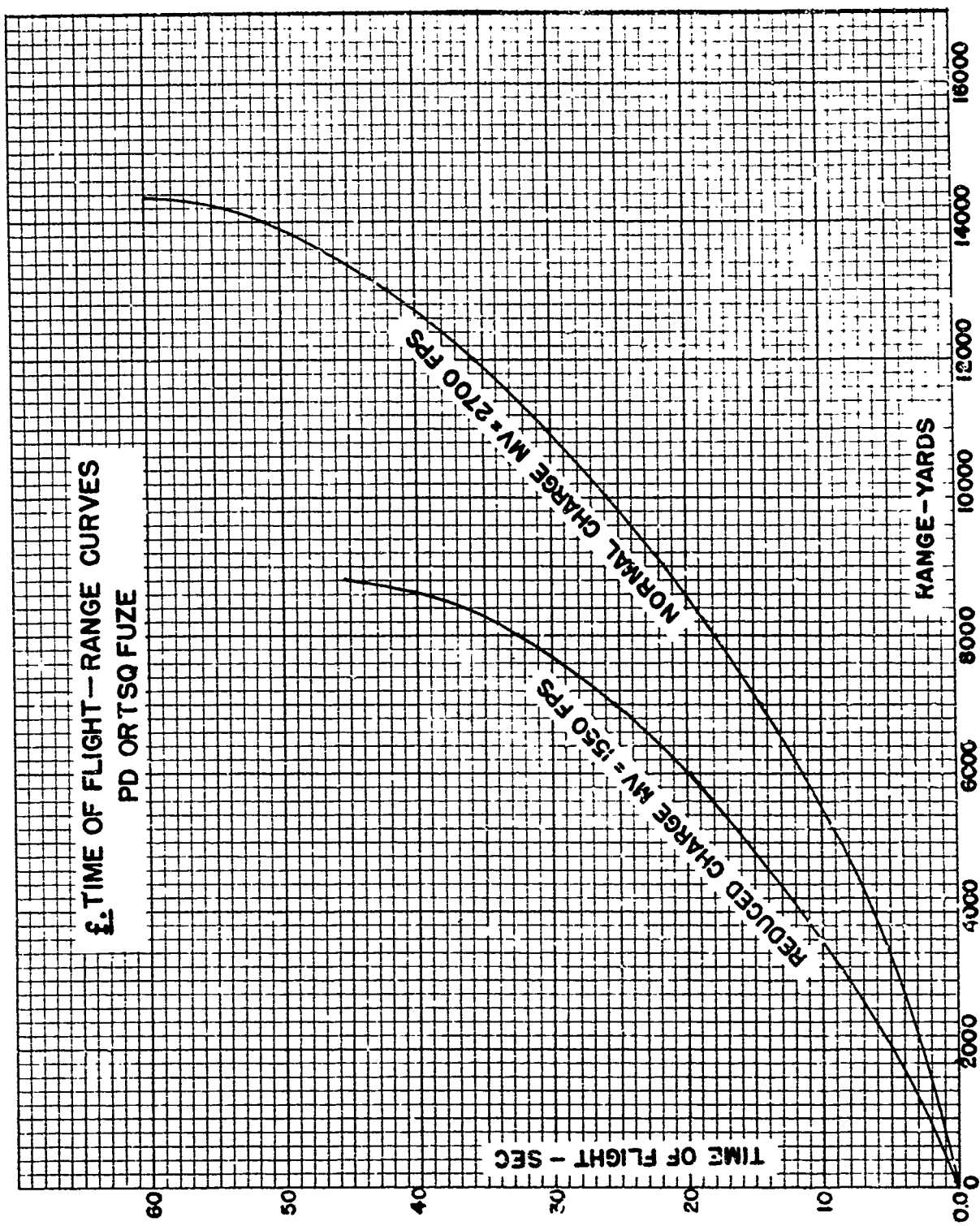

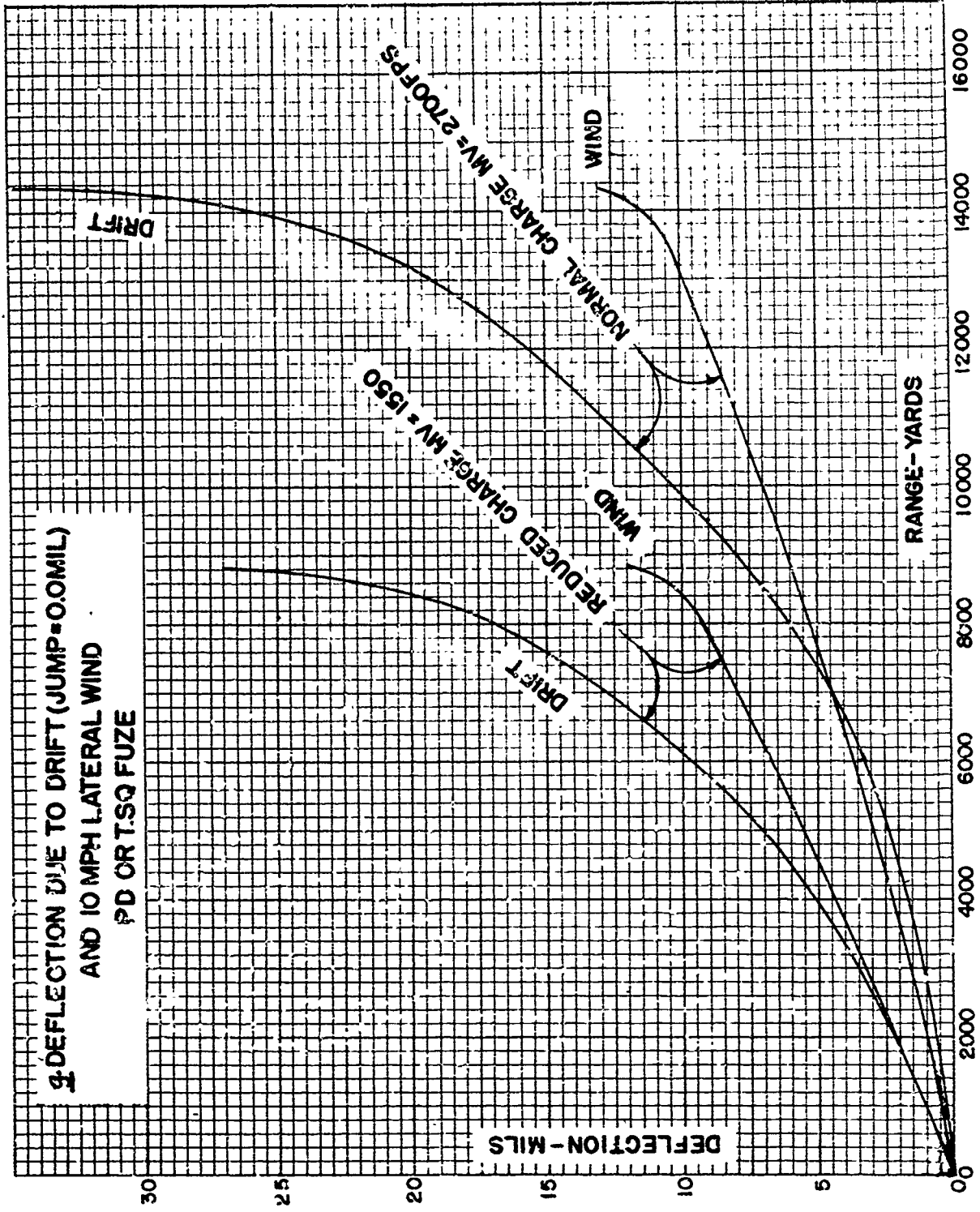

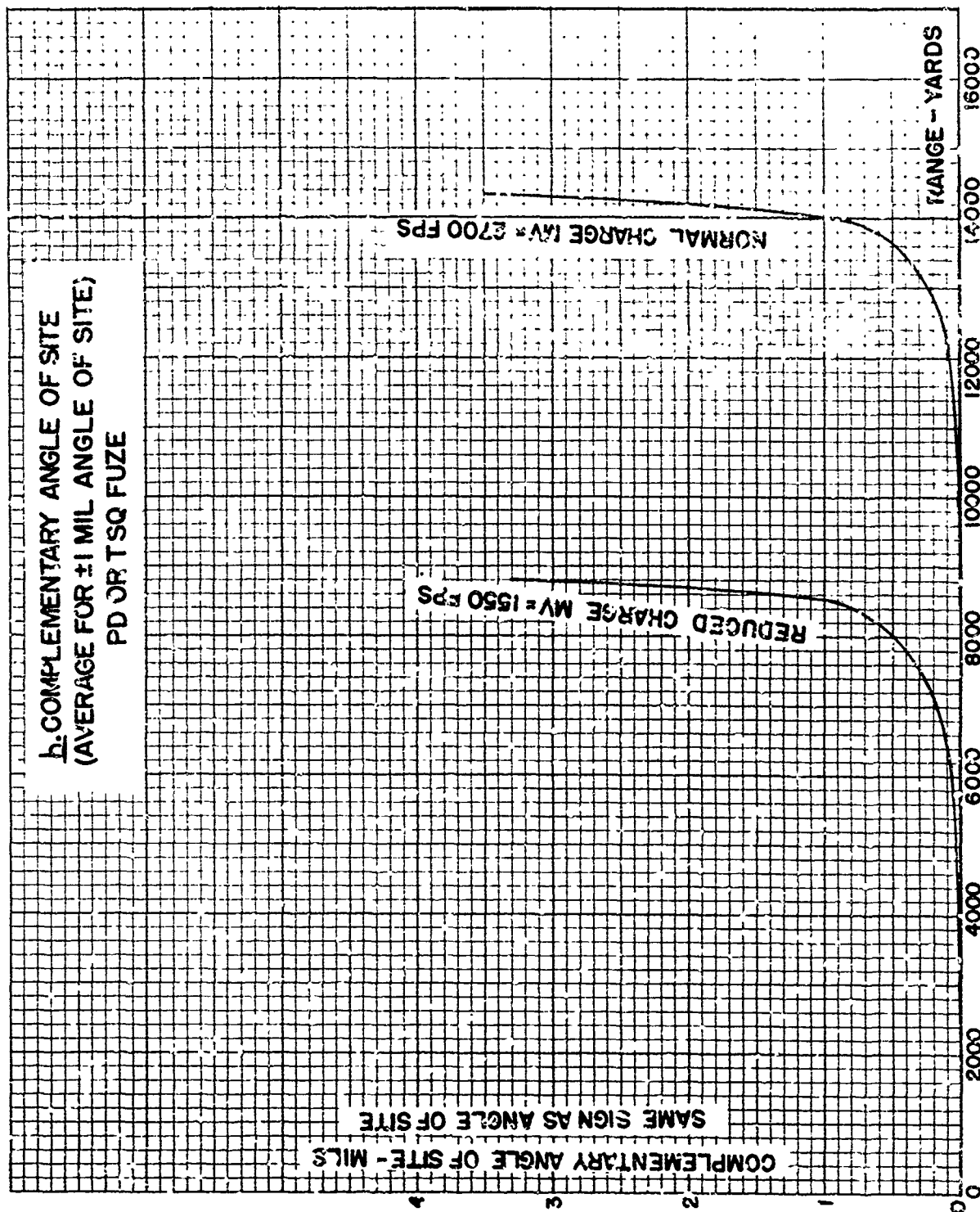

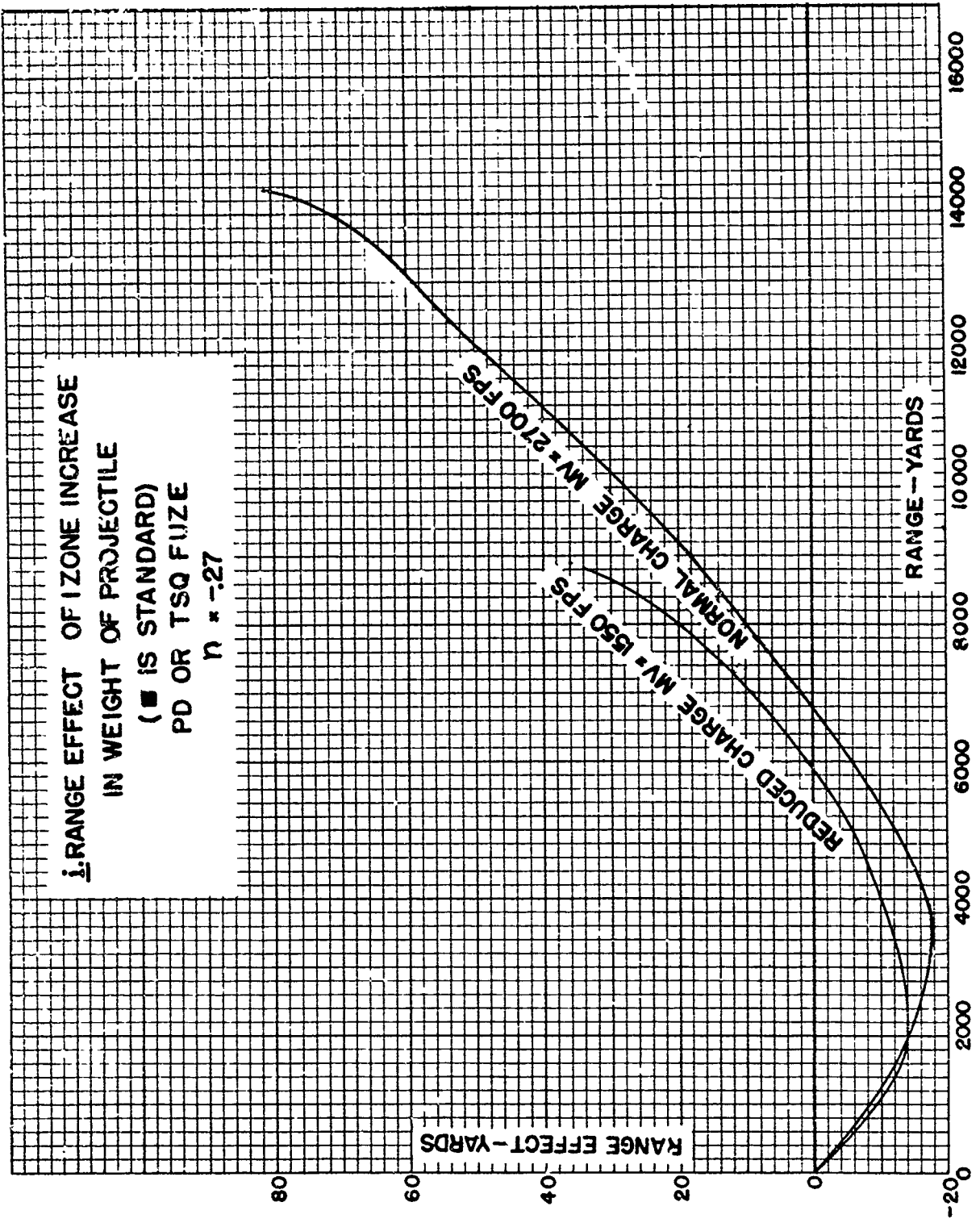

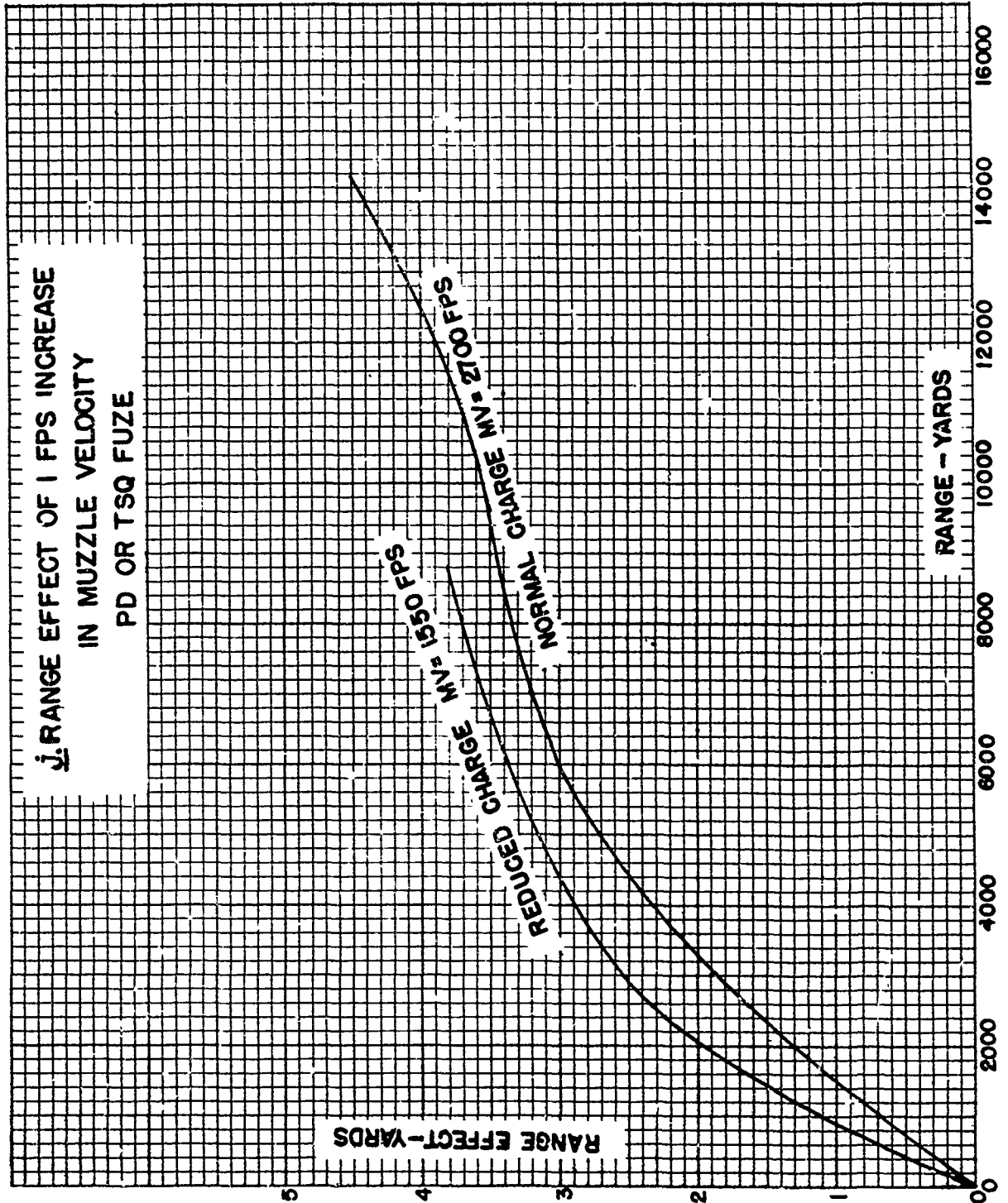

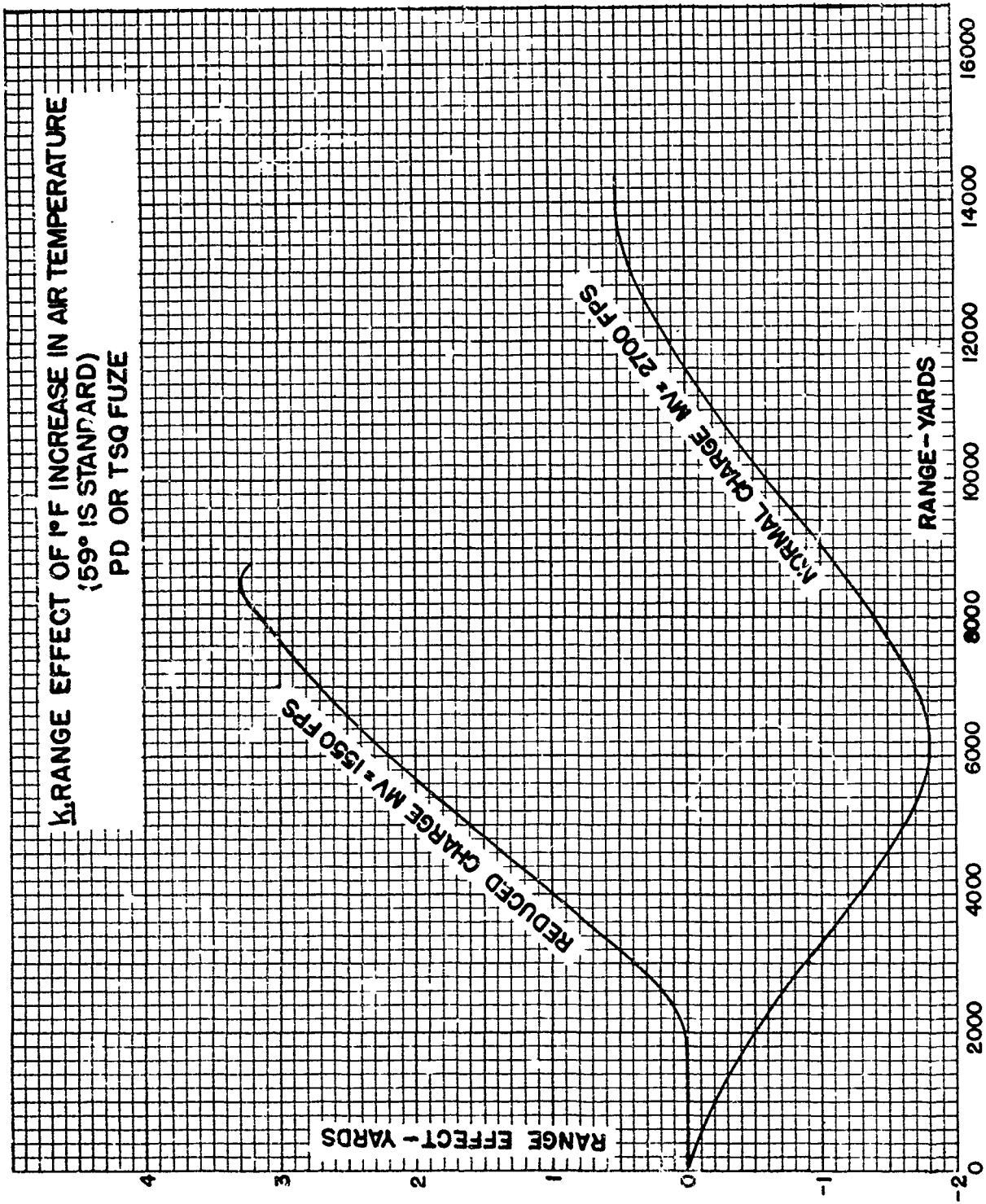

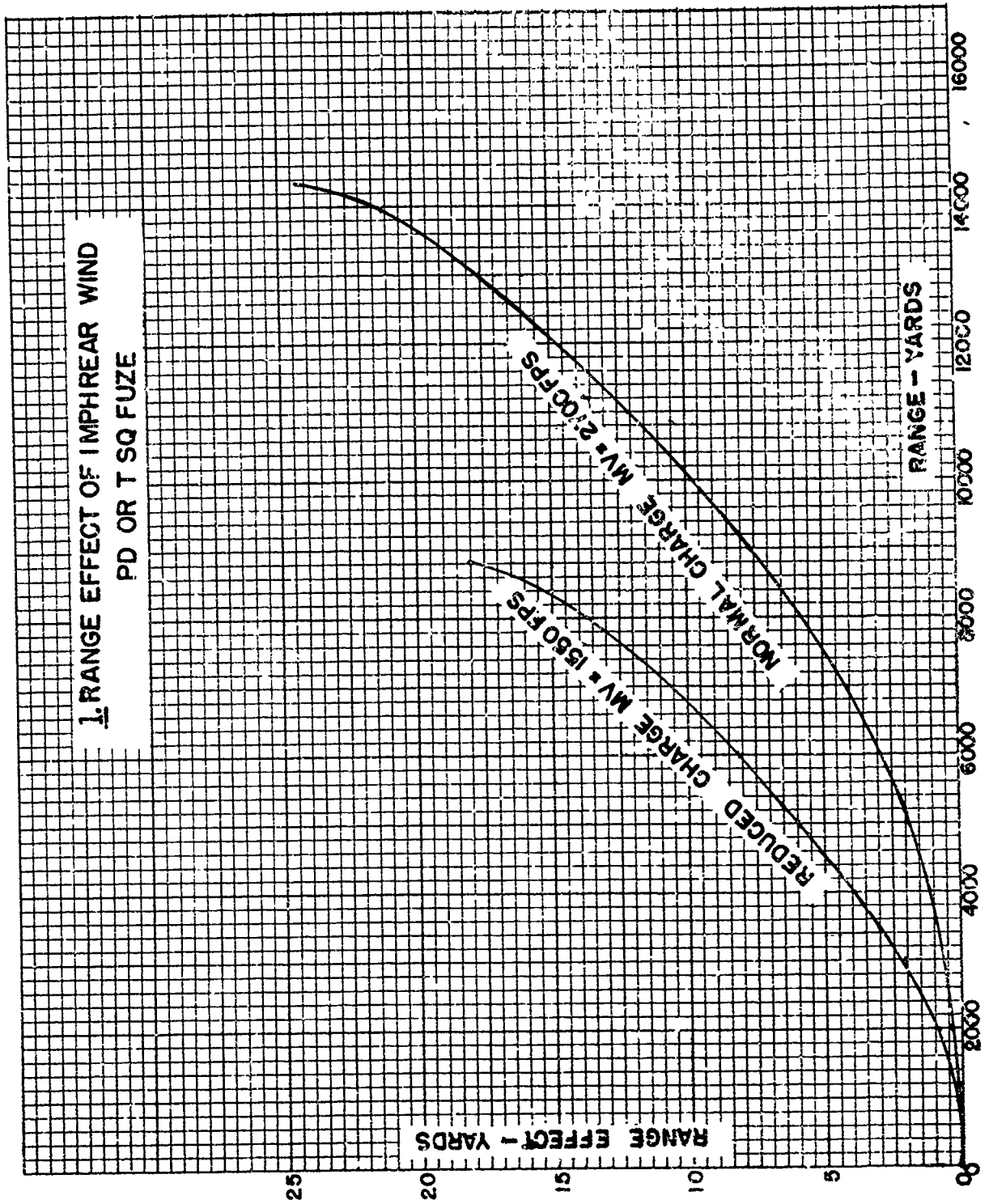

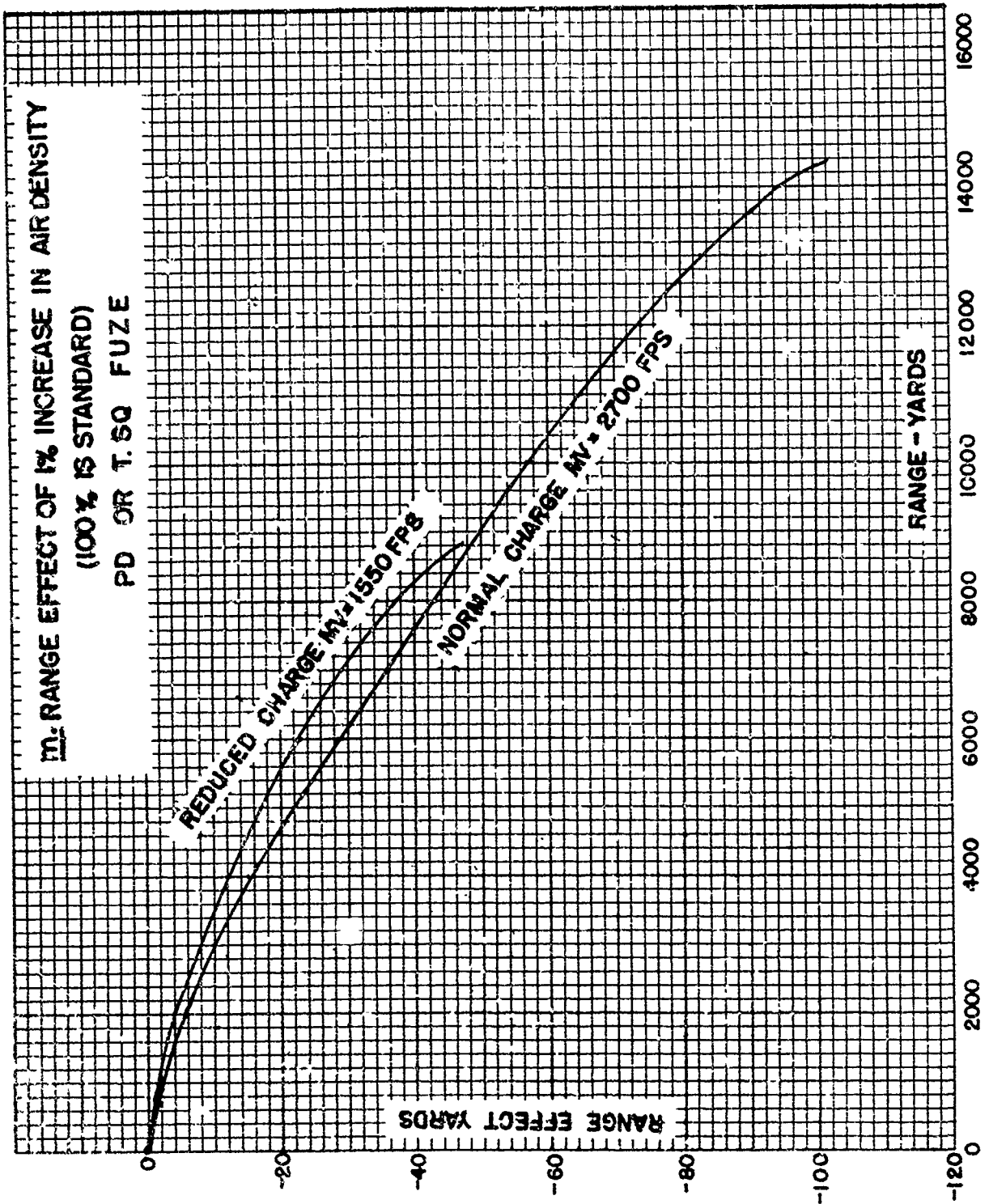

SECTION V
EFFECT DATA

	<u>Paragraph</u>
Fragmentation - - - - -	9
Effectiveness - - - - -	10
Ricochet data - - - - -	11
Penetration - - - - -	12

9. Fragmentation. The data on fragmentation of the 76-mm HE Shell M42A1 were taken from TM9-1907, "Ballistic Data, Performance of Ammunition" (Sep 1944) and Vol. III of "Terminal Ballistic Data" (Sep 1945). The initial fragment velocity is 2,260 fps.

a. Casualties.

TABLE 40
CASUALTIES

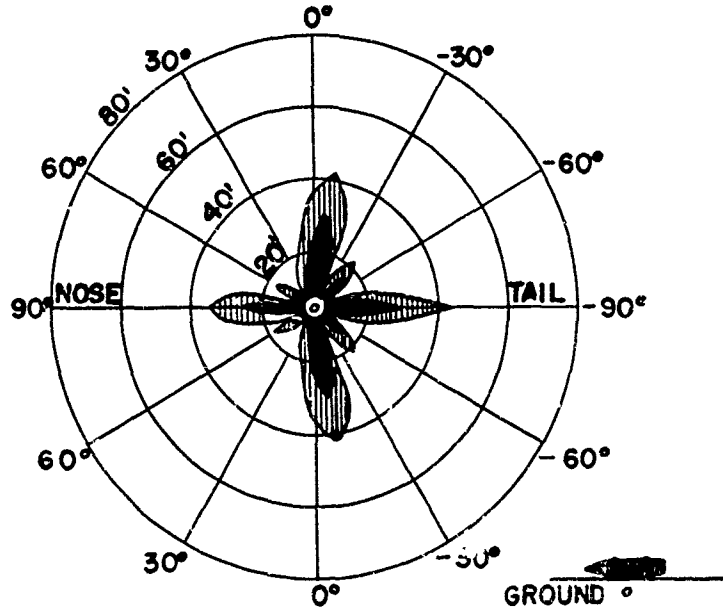

Distance from burst (ft)	Total number of effective fragments	Average number of effective frag- ments per sq ft	<u>For the lightest effective fragment</u>	
			<u>Weight</u> (oz)	<u>Velocity</u> (fps)
r	N	B	m	v
20	547	0.109	0.026	1510
30	498	0.04±0	0.033	1340
40	465	0.0231	0.040	1220
60	409	0.0020	0.055	1040
80	370	0.0046	0.067	943
100	331	0.0026	0.080	862
150	282	0.0010	0.108	742
200	244	0.0005	0.137	660
300	191	0.0002	0.197	549
400	149	0.0001	0.275	466

CASUALTIES

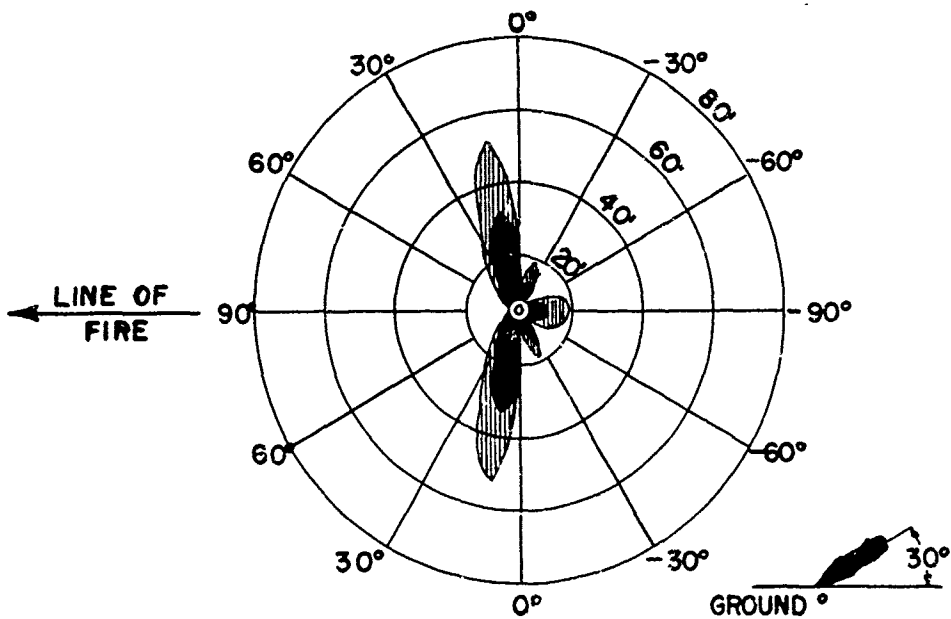

INCLINATION 0°
HEIGHT OF BURST 0 FT
REMAINING VELOCITY 0 FPS





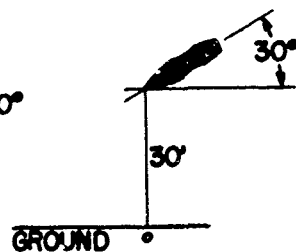
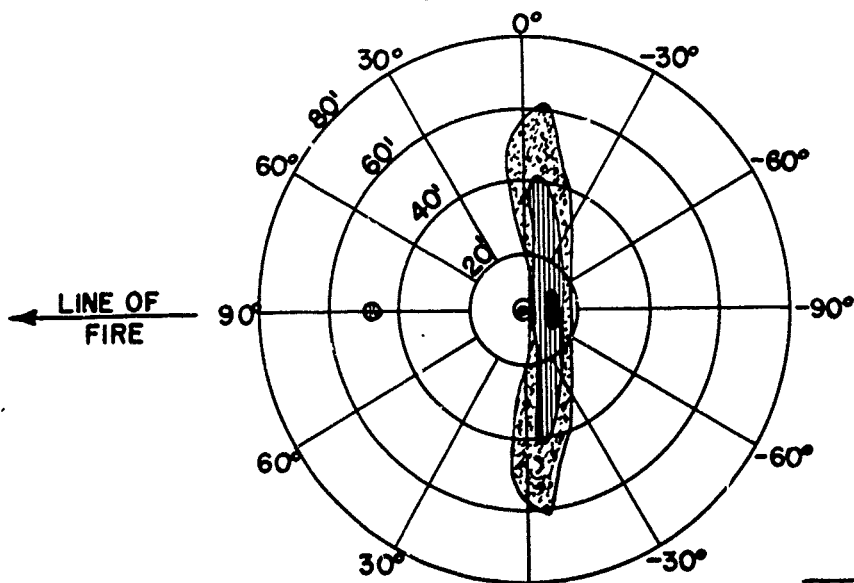

	AT LEAST 1 HIT PER 4 SQ FT	INCLINATION 30°
	AT LEAST 1 HIT PER 10 SQ FT	HEIGHT OF BURST 0 FT
		REMAINING VELOCITY 815 FPS

CASUALTIES

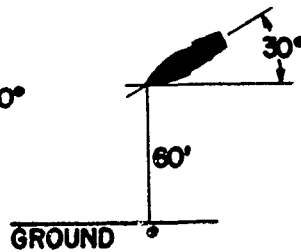
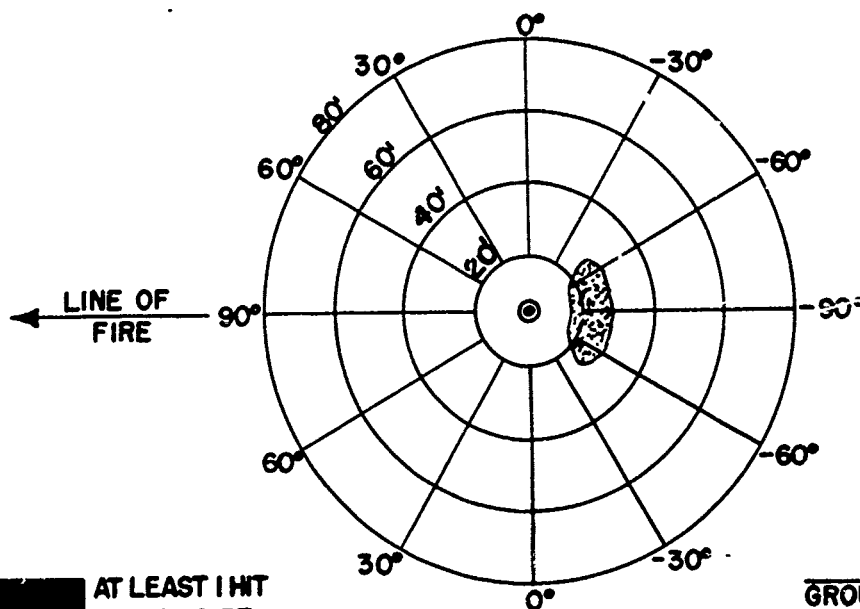

INCLINATION 30°
HEIGHT OF BURST 30 FT
REMAINING VELOCITY 815 FPS



-  AT LEAST 1 HIT PER 4 SQ FT
-  AT LEAST 1 HIT PER 10 SQ FT
-  AT LEAST 1 HIT PER 25 SQ FT

INCLINATION 30°
HEIGHT OF BURST 60 FT
REMAINING VELOCITY 815 FPS

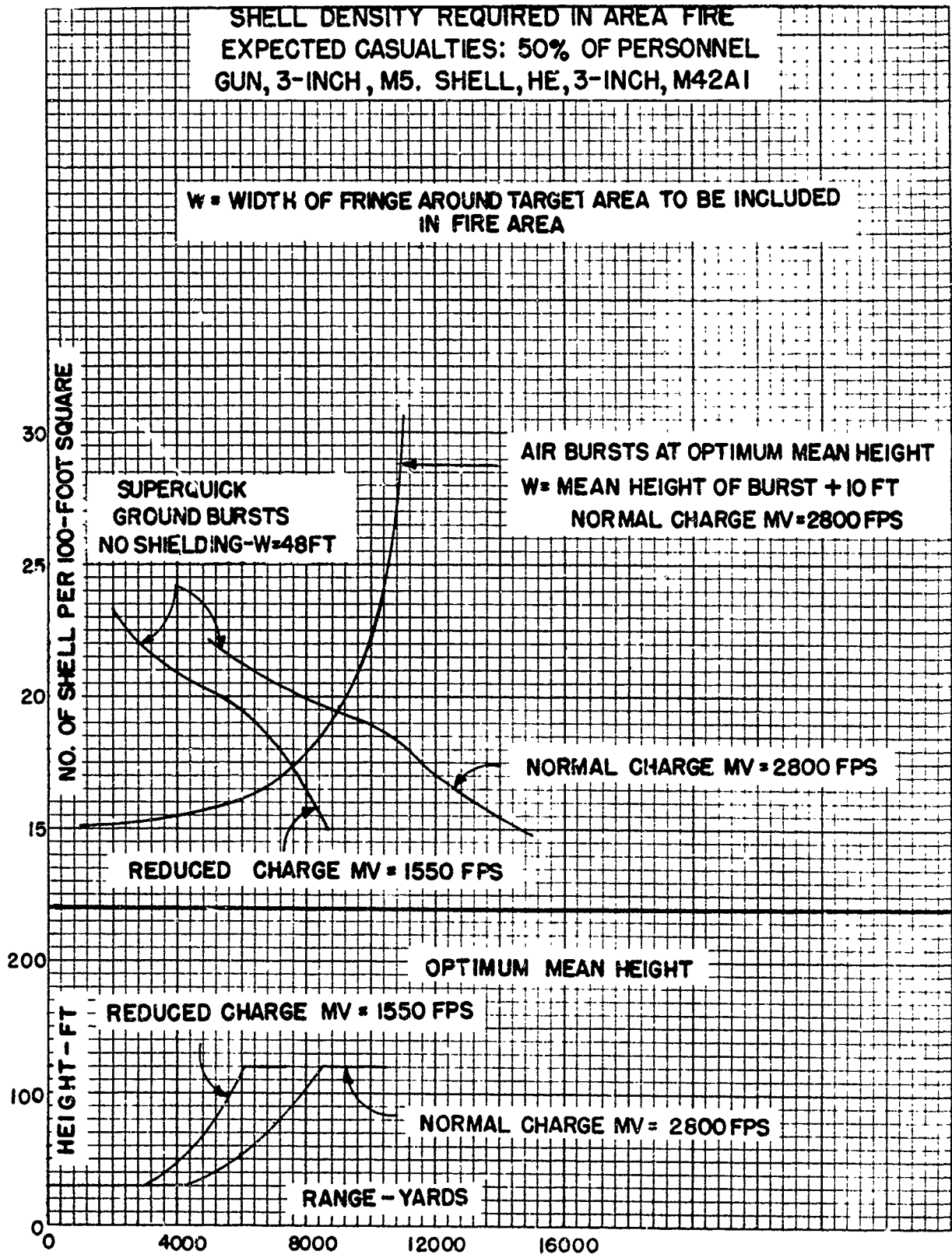

b. Perforation of 1/8-inch Mild Steel.

TABLE 41
PERFORATION OF 1/8 IN. MILD STEEL

Distance from burst (ft)	Total number of effective fragments	Average number of effective frag- ments per sq ft	For the lightest effective fragment	
			Weight (oz)	Velocity (fps)
r	N	B	m	v
20	284	0.0565	0.106	1,860
30	242	0.0214	0.139	1,740
40	205	0.0102	0.177	1,600
60	151	0.0033	0.270	1,400
80	113	0.0014	0.375	1,270
100	90	0.0007	0.480	1,180
130	64	0.0003	0.648	1,080
160	43	0.0001	0.825	1,020
190	28	0.0001	1.01	963

PERFORATION OF 1/8-INCH MILD STEEL

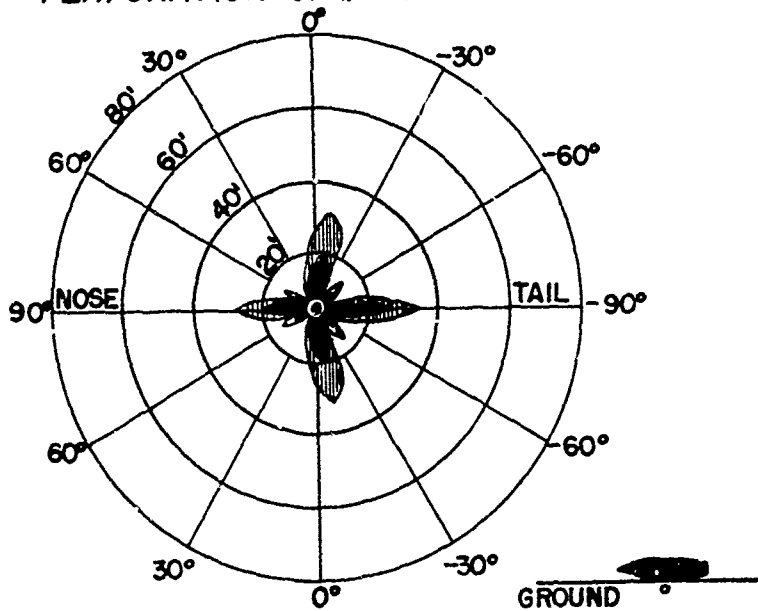

INCLINATION 0°
HEIGHT OF BURST 0 FT
REMAINING VELOCITY 0 FPS

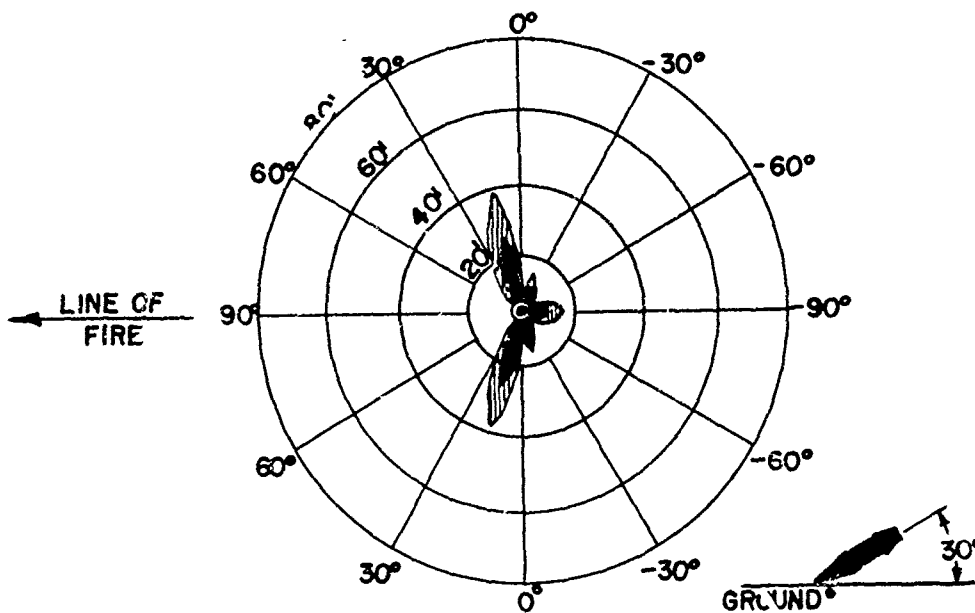

AT LEAST 1 HIT PER 4 SQ FT
 AT LEAST 1 HIT PER 10 SQ FT
 INCLINATION 30°
 HEIGHT OF BURST 0 FT
 REMAINING VELOCITY 815 FPS

PERFORATION OF 1/8-INCH MILD STEEL

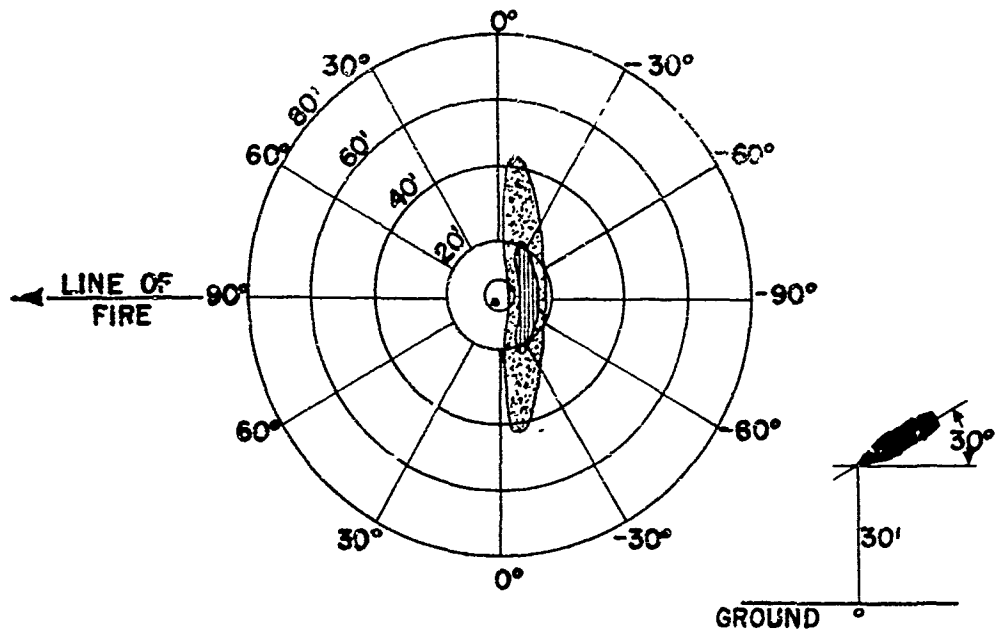

INCLINATION 30°
HEIGHT OF BURST 30 FT
REMAINING VELOCITY 815 FPS

 AT LEAST 1 HIT PER 10 SQ FT

 AT LEAST 1 HIT PER 25 SQ FT

SHELL DENSITY REQUIRED IN AREA
EXPECTED PERFORATIONS 1/8-INCH MILD STEEL:
50% OF ELEMENTS 2 SQ FT IN AREA
GUN, 3-INCH, M5. SHELL, HE, 3-INCH, M42A1

SUPERQUICK GROUND BURSTS - NO SHIELDING

WIDTH OF FRINGE AROUND TARGET AREA TO BE INCLUDED IN FIRE AREA = 18 FT

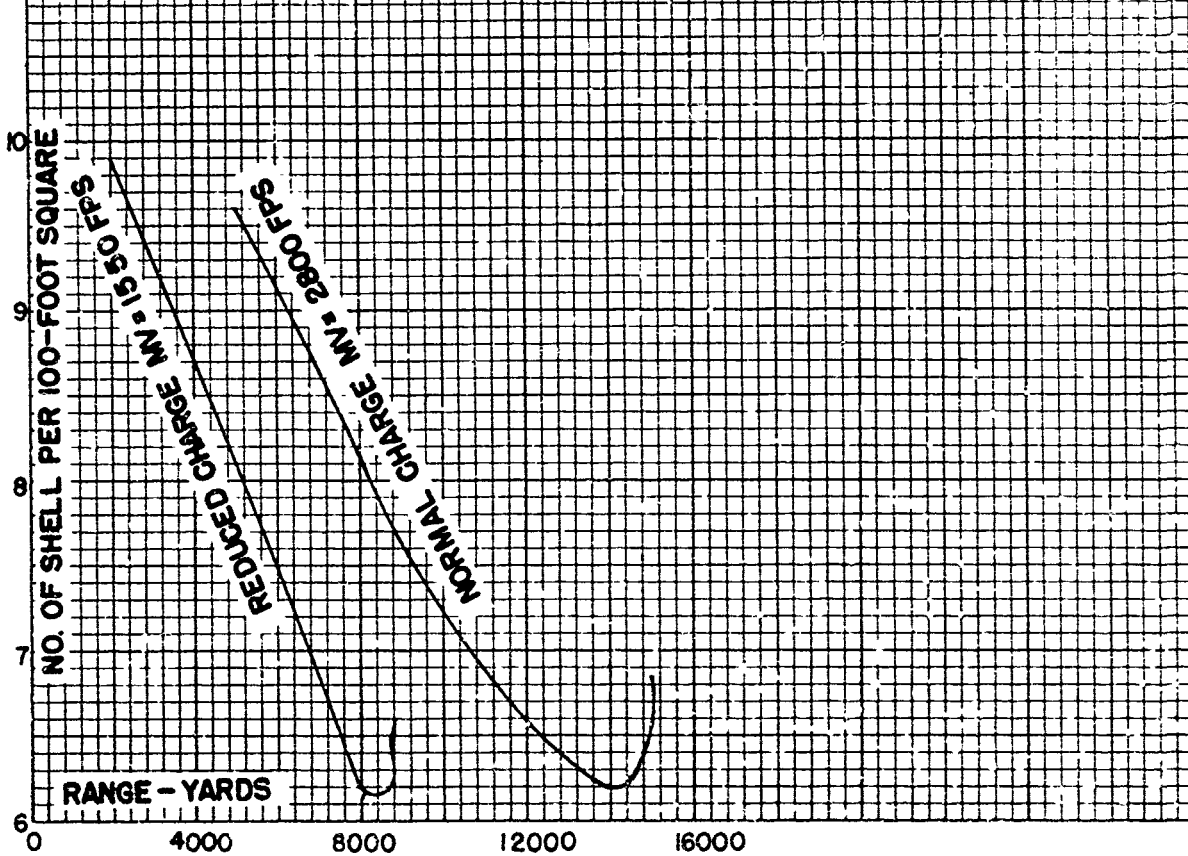

10. **Effectiveness.** The following data were taken from Vol. III of "Terminal Ballistic Data". They pertain to the 76-mm HE Shell M42A1 with a PD, TSQ or MT Fuze, fired at a muzzle velocity of 2,700 fps.

NUMBER OF ROUNDS REQUIRED AGAINST ENEMY ARTILLERY FOR 90%
PROBABILITY OF AT LEAST ONE EFFECTIVE HIT IN AIMED FIRE

Range yd	Type of Fire		
	Impact	Time	Time and Impact
2000	6	270	13
5000	55	130	87

11. **Ricochet Data.** The following data were taken from Vol. III of "Terminal Ballistic Data". They pertain to the 76-mm HE Shell M42A1 with the PD Fuze M48 set for 0.05 sec delay, fired at a muzzle velocity of 2,700 fps (the PL Fuzes M48A1, M48A2 and M51A4 have 0.15 sec delay).

TABLE 75

Range yd	Angle of Fall mils	Angle of Recovery to Burst mils	Impact yd	Height of Burst ft	PE in
					Height of Burst ft
1,000	8	20	40	3	0
2,000	20	35	33	4	1
3,000	38	60	26	5	1
4,000	65	100	21	6	1
5,000	106	150	16	7	1
6,000	163	210	12	7	2
7,000	233	280	9	7	2
8,000	315	300	6	6	1
9,000	407	315	4	4	1

12. **Penetration.** The data on penetration of concrete by the HE Shell M42B1 with the CP Fuze M78 were taken from TM9-1907, "Ballistic Data, Performance of Ammunition". The data on penetration into medium earth and logs by the HE Shell M42A1 with the DP or CP Fuze were taken from Vol. III of "Terminal Ballistic Data".

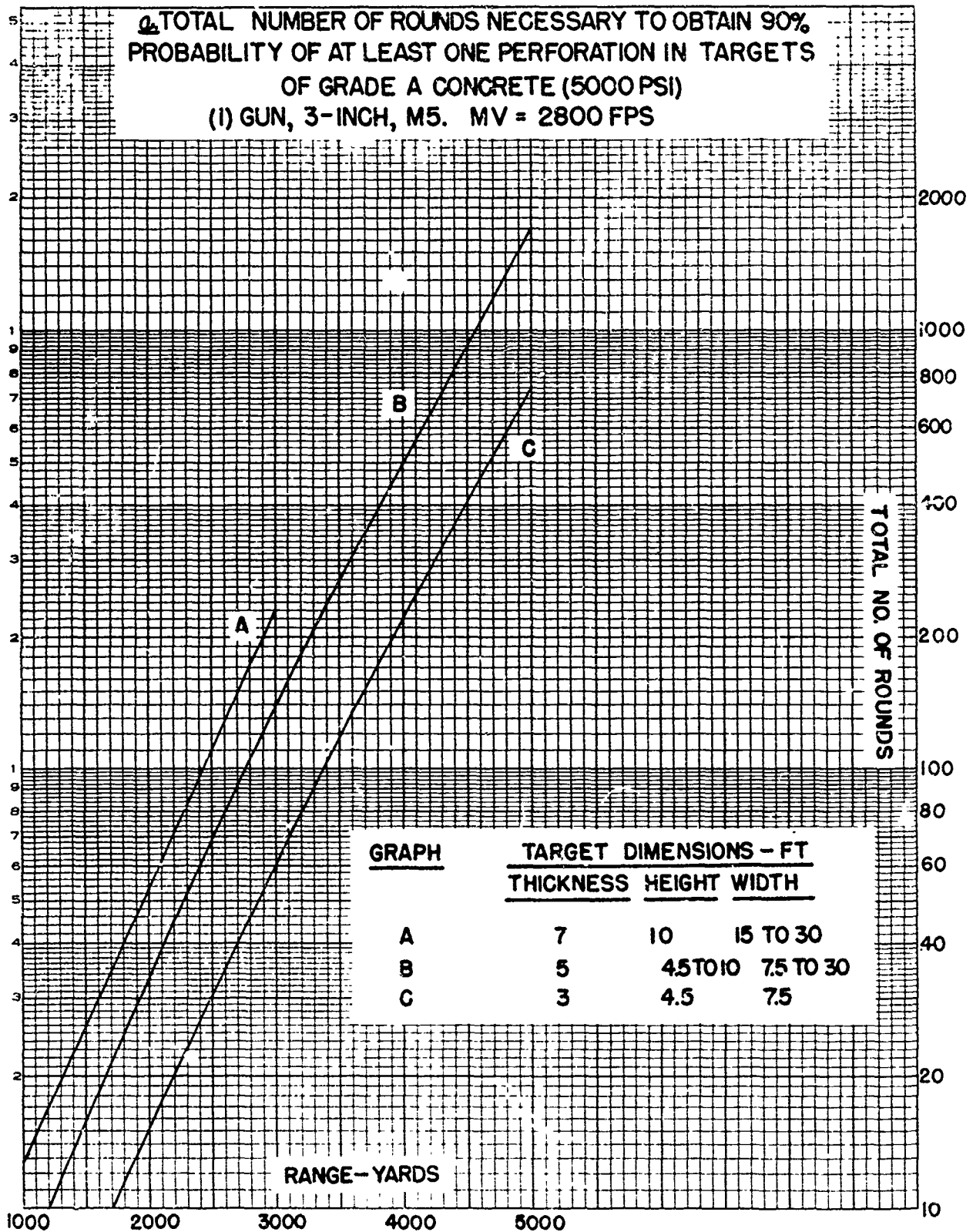

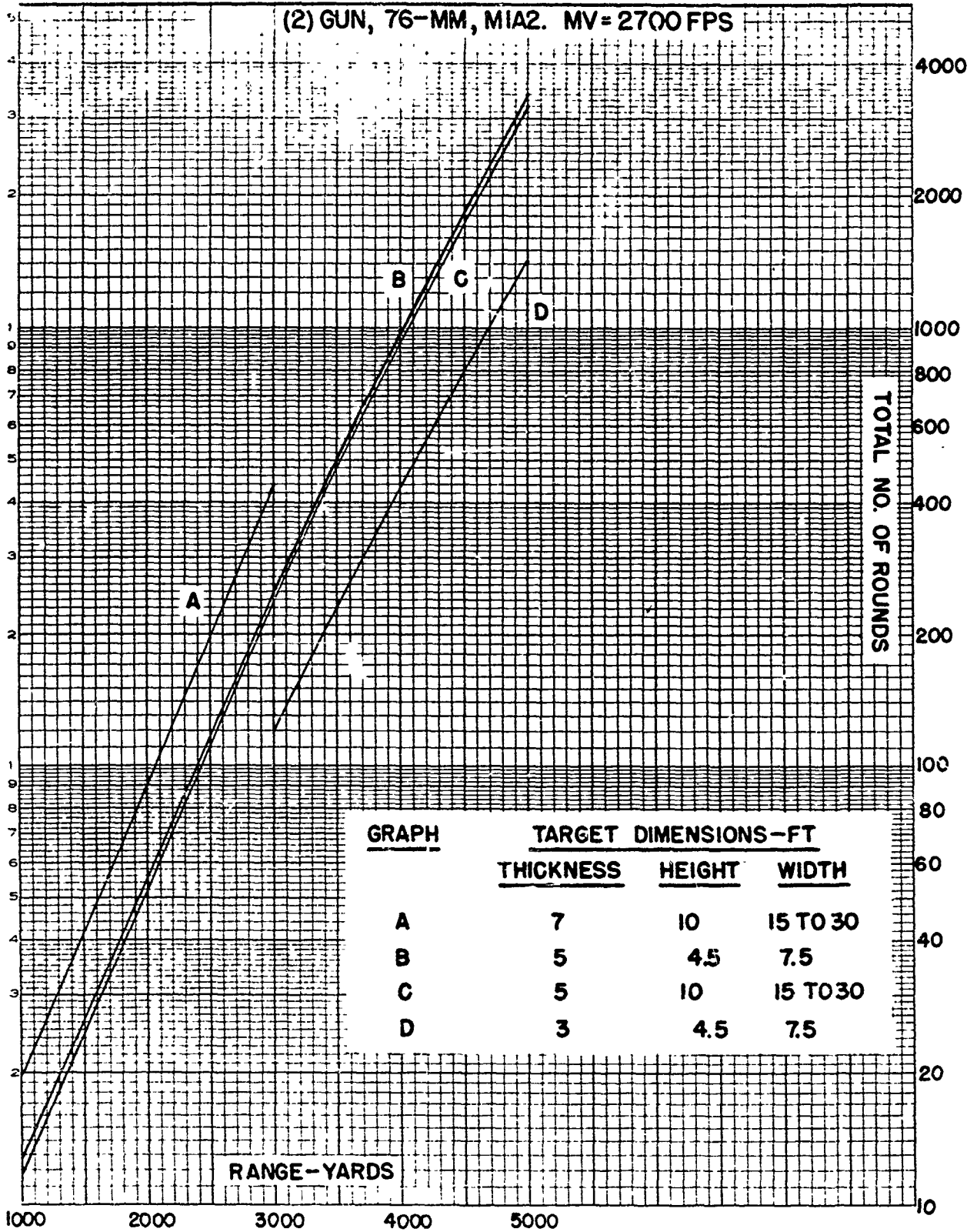

2 TOTAL NUMBER OF ROUNDS NECESSARY TO OBTAIN 90% PROBABILITY OF ENOUGH HITS TO MAKE A BREACH 12 FT WIDE IN A CONCRETE WALL 10 FT HIGH.
GUN, 3-INCH, M5. MV=2800 FPS
GUN, 76-MM, M1A2. MV = 2700 FPS
RANGE = 1000 YD

<u>WALL THICKNESS</u>	<u>NO. OF ROUNDS</u>
6 FT	100
10 FT	360

3 PENETRATION INTO MEDIUM EARTH AND LOGS

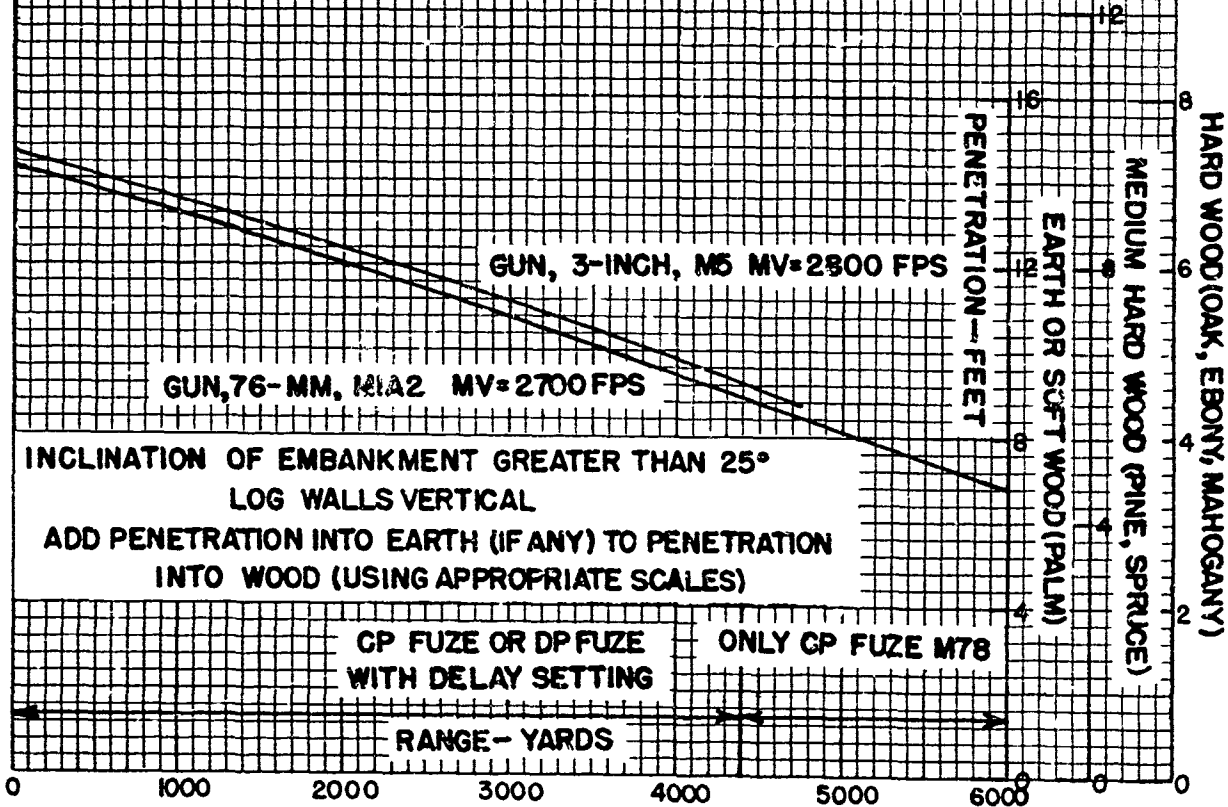

Ballistic Research Laboratories
Handbook of Ballistic and
Engineering Data for Ammunition,
No. 76-1-62.

Ballistic Research Lab.
Aberdeen Proving Ground,
Maryland.
3 February 1949

BALLISTIC AND ENGINEERING DATA
for
Projectile, APC, 76-mm (3-inch), M62A1
with
Fuze, BD, M66A1

<u>Section</u>		<u>Paragraph</u>
I	General -----	1
II	Description -----	2 - 4
III	Interior ballistic data ---	5
IV	Exterior ballistic data --	6 - 7
V	Effect data -----	8

SECTION I
GENERAL

	<u>Paragraph</u>
Purpose - - - - -	1

1. Purpose. The purpose of this number of the handbook is to furnish a concise collection of information regarding the shape, dynamics, ballistics, and effects of the 76-mm (3-inch) Armor-piercing Capped Projectile M62A1 with the Base Detonating Fuze M66A1, which contains a tracer composition. This information is collected from the drawings, reports, firing tables, and technical manuals pertaining to this ammunition.

ALL DIMENSIONS IN CALIBERS
1 CAL = 3.000"

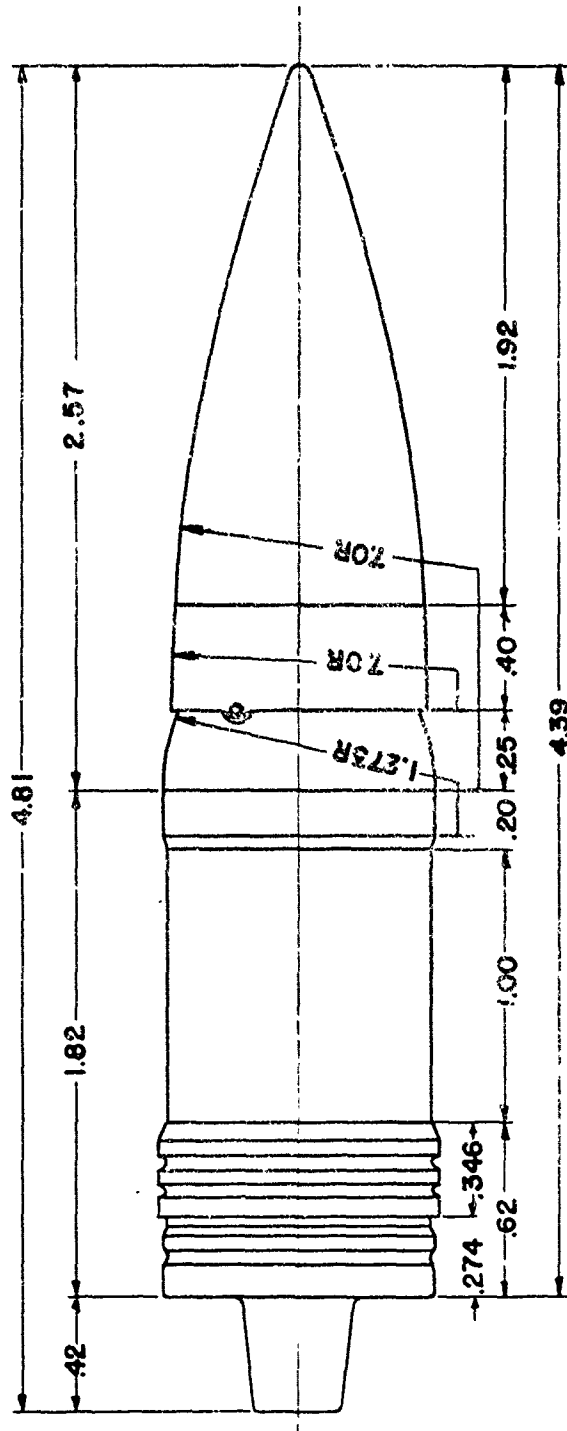

PROJECTILE, APC, 76-MM, M62A1
FUZE, BD, M66A1

**SECTION II
DESCRIPTION**

	<u>Paragraph</u>
Drawings - - - - -	2
Dimensions - - - - -	3
Physical characteristics - - - - -	4

2. Drawings.

Projectile: Metal parts assembly and details	75-2-292
Fuze: Assembly	73-2-178
Details	73-2-179
Details	73-2-180

3. Dimensions.

Fuze: Length (outside)	0.42 cal
Band: Distance from base	0.274 cal
Width	0.346 cal
Body: Cylindrical length	1.82 cal
Ogival length (outside)	0.25 cal
Radius of ogival arc	1.273 cal
Cap: Length (outside)	0.40 cal
Radius of ogival arc	7.00 cal
Windshield: Length	1.92 cal
Radius of ogival arc	7.00 cal
Length: Ogive	2.57 cal
Projectile without fuze	4.39 cal
Projectile and fuze	4.81 cal

4. Physical characteristics.

Weight (standard)	15.40 lb
Base of projectile to center of gravity	1.404 cal
Axial moment of inertia	16.97 lb. in. ²
Transverse moment of inertia	104.8 lb. in. ²

**SECTION III
INTERIOR BALLISTIC DATA**

Paragraph

Theoretical yaw in bore - - - - - 5

5. Theoretical yaw in bore.

Minimum	8 min
Maximum	13 min

**SECTION IV
EXTERIOR BALLISTIC DATA**

Paragraph

Aerodynamic data - - - - - 6
Firing table data - - - - - 7

6. Aerodynamic data.

a. Drag. The following results were obtained from resistance firings.

<u>Muzzle Velocity</u> fps	<u>Drag Function</u>	<u>Form Factor</u> i	<u>Ballistic Coefficient</u> C	<u>Drag Coef.</u> K_D
2000	G_6	1.052	1.627	0.157
2600	G_6	1.052	1.627	0.129

b. Stability. Ballistic Research Laboratory Report No. 427, "Stability of 3-inch Armor-piercing Projectiles", gives the results obtained from stability firings of the 3-inch APC Projectile M62 with BD Fuze M66A1 from the 3-inch Antitank Gun M5, whose twist of rifling is 1/40. The 76-mm Tank Gun M1A2 has a twist of rifling of 1/32.

<u>Muzzle Velocity</u> fps	<u>Moment Coefficient</u> K_M	<u>Stability Factor</u> <u>Twist of Rifling</u>	
		1/40	1/32
1600	1.48	1.09	1.70
2600	1.41	1.14	1.78

7. Firing table data.

Gun	76-mm M1A2 (Tank)	3-inch M5 (Antitank)
Twist of rifling	1/32	1/40
Muzzle Velocity	2600 fps	2600 fps
FT	76-C-1	3-W-1

OCM item 16167 standardized the 3-inch AP Projectile M62, which was later called an APC Projectile. OCM item 18656 authorized its use in the 76-mm Gun M1. The 76-mm Guns M1 and M1A1, with 1/40 twist, are now obsolete.

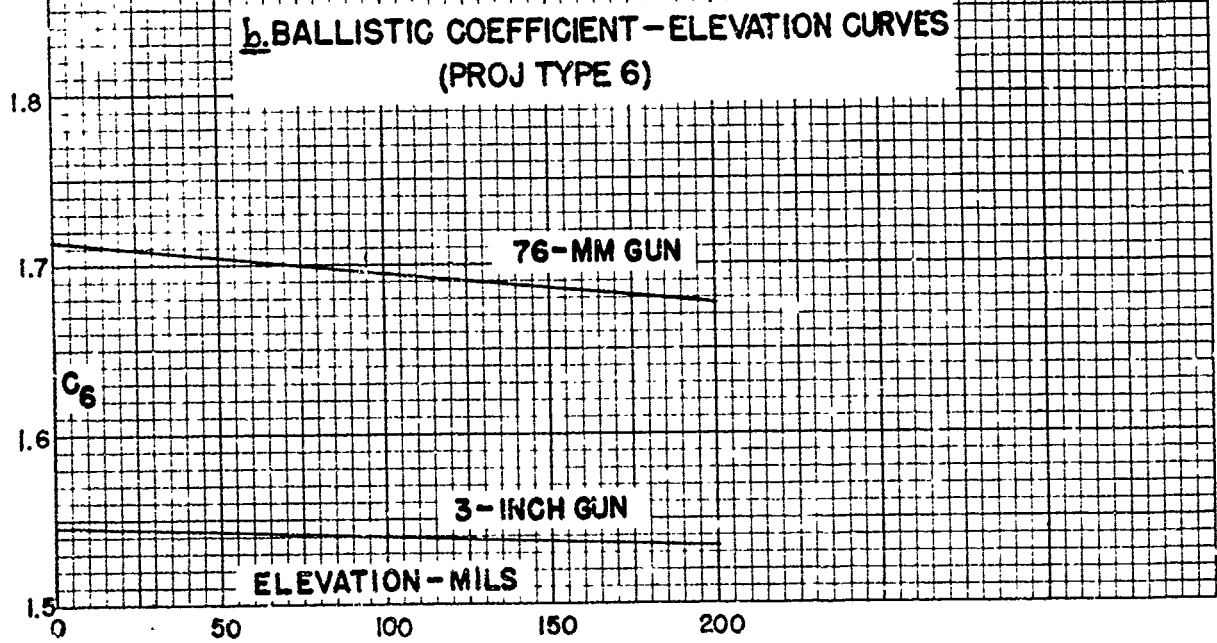
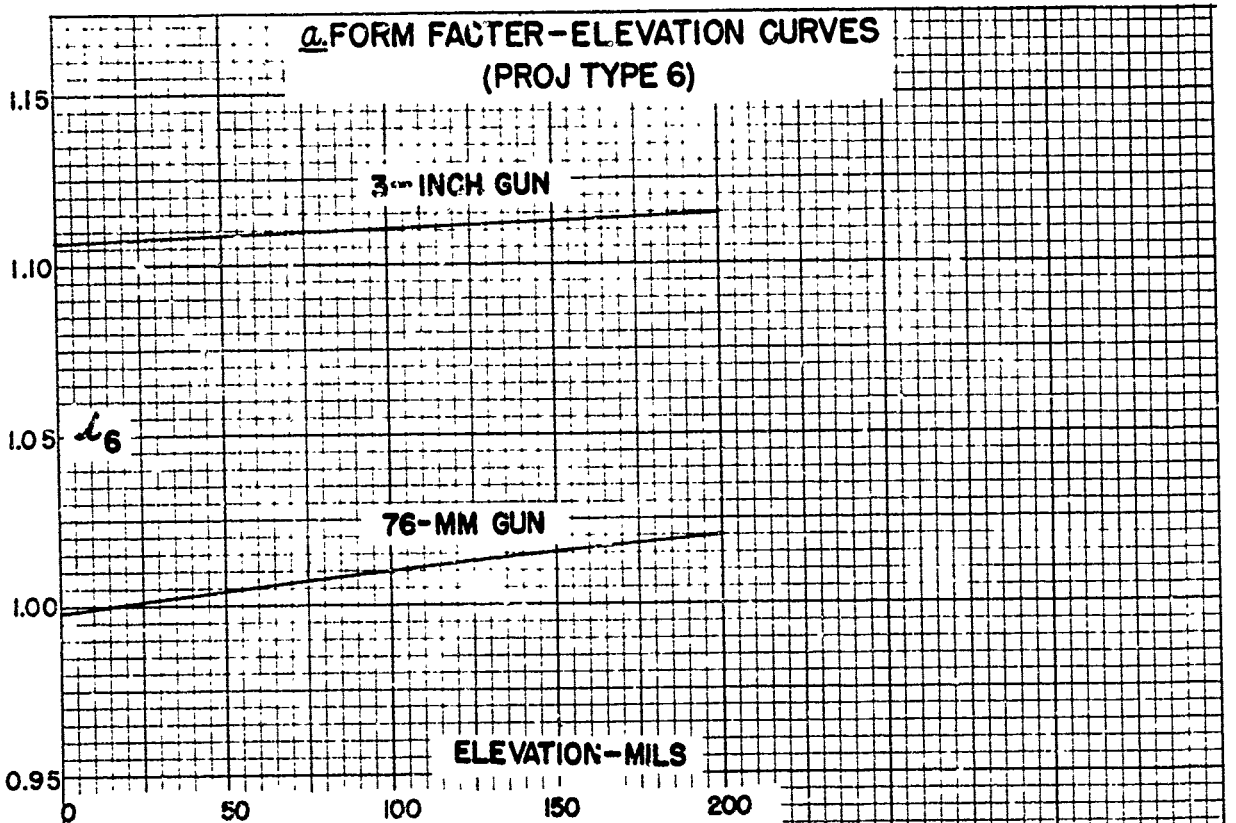

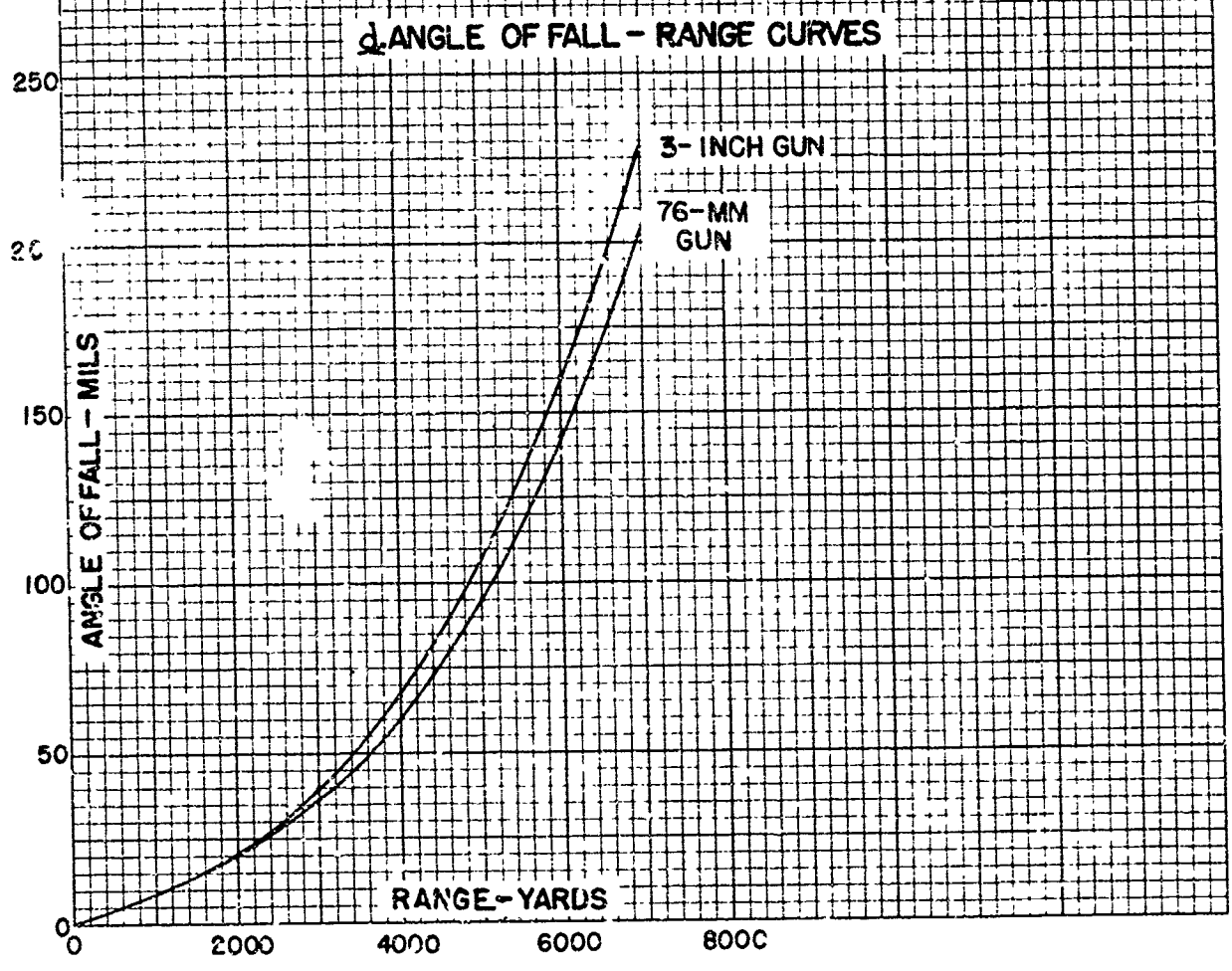
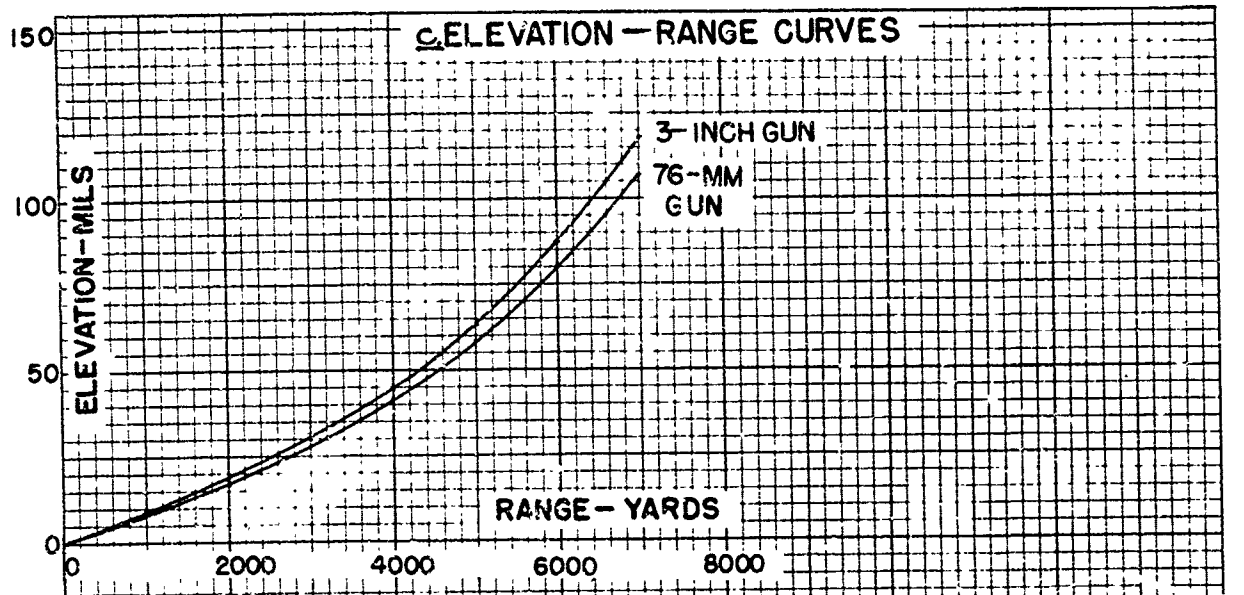

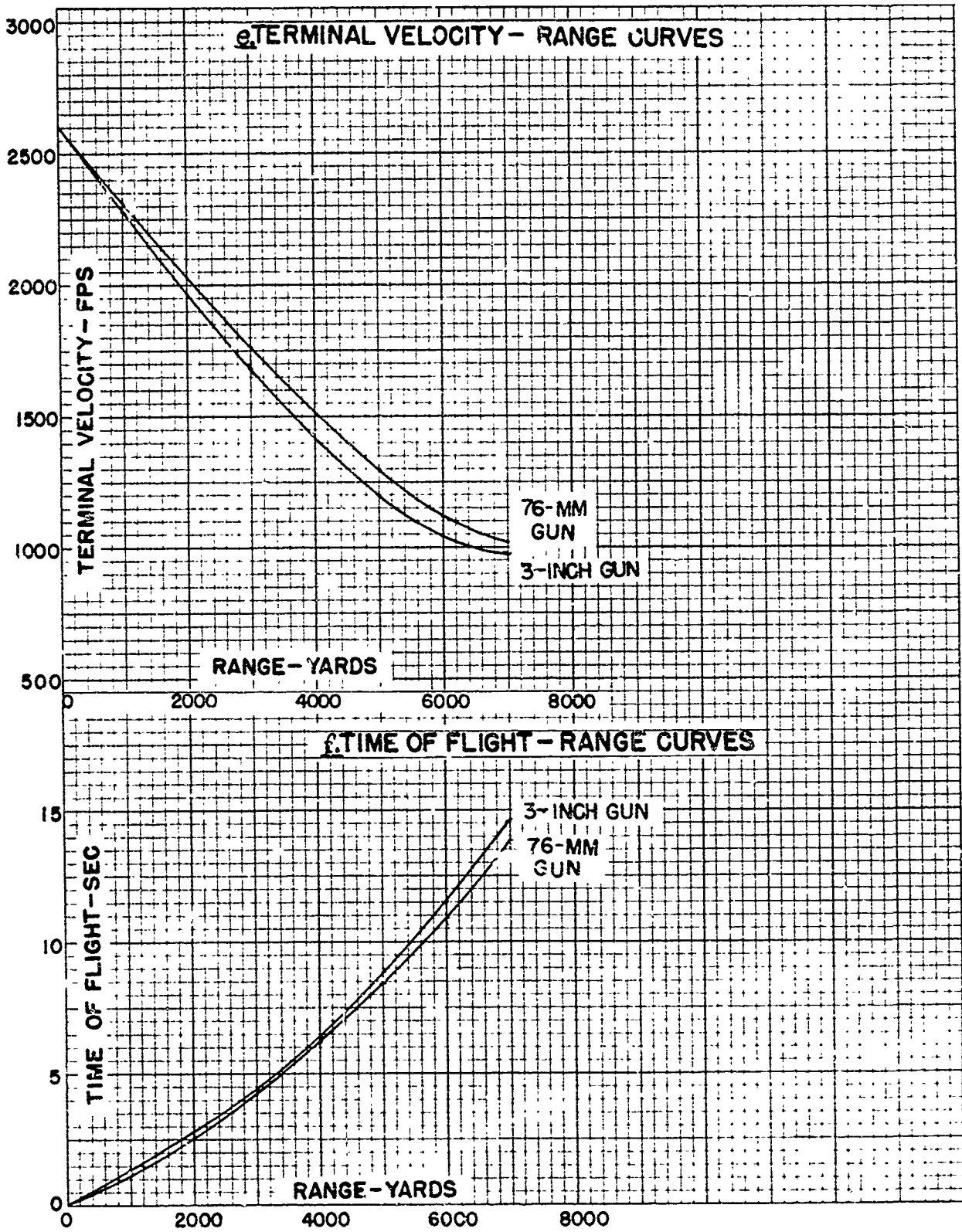

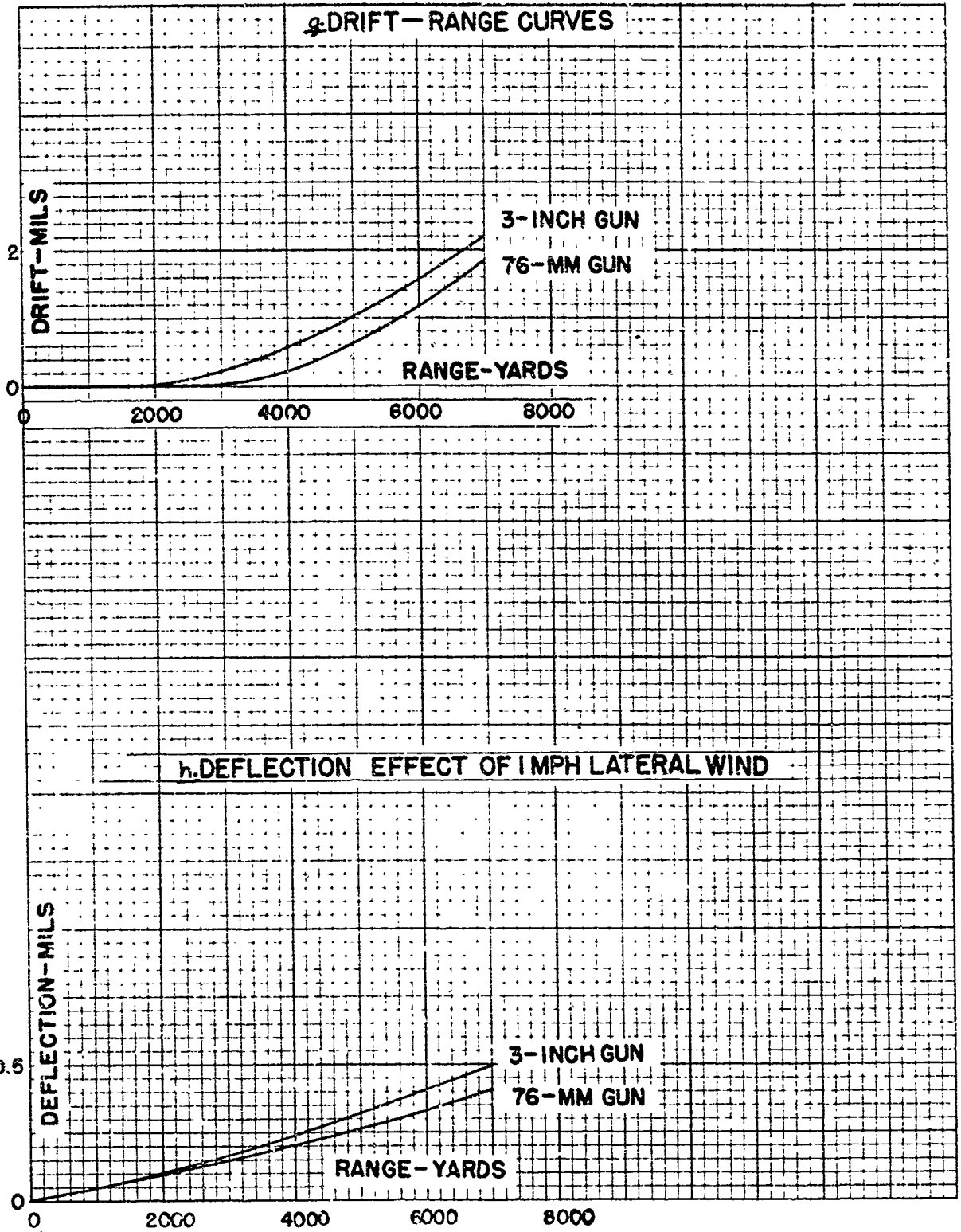

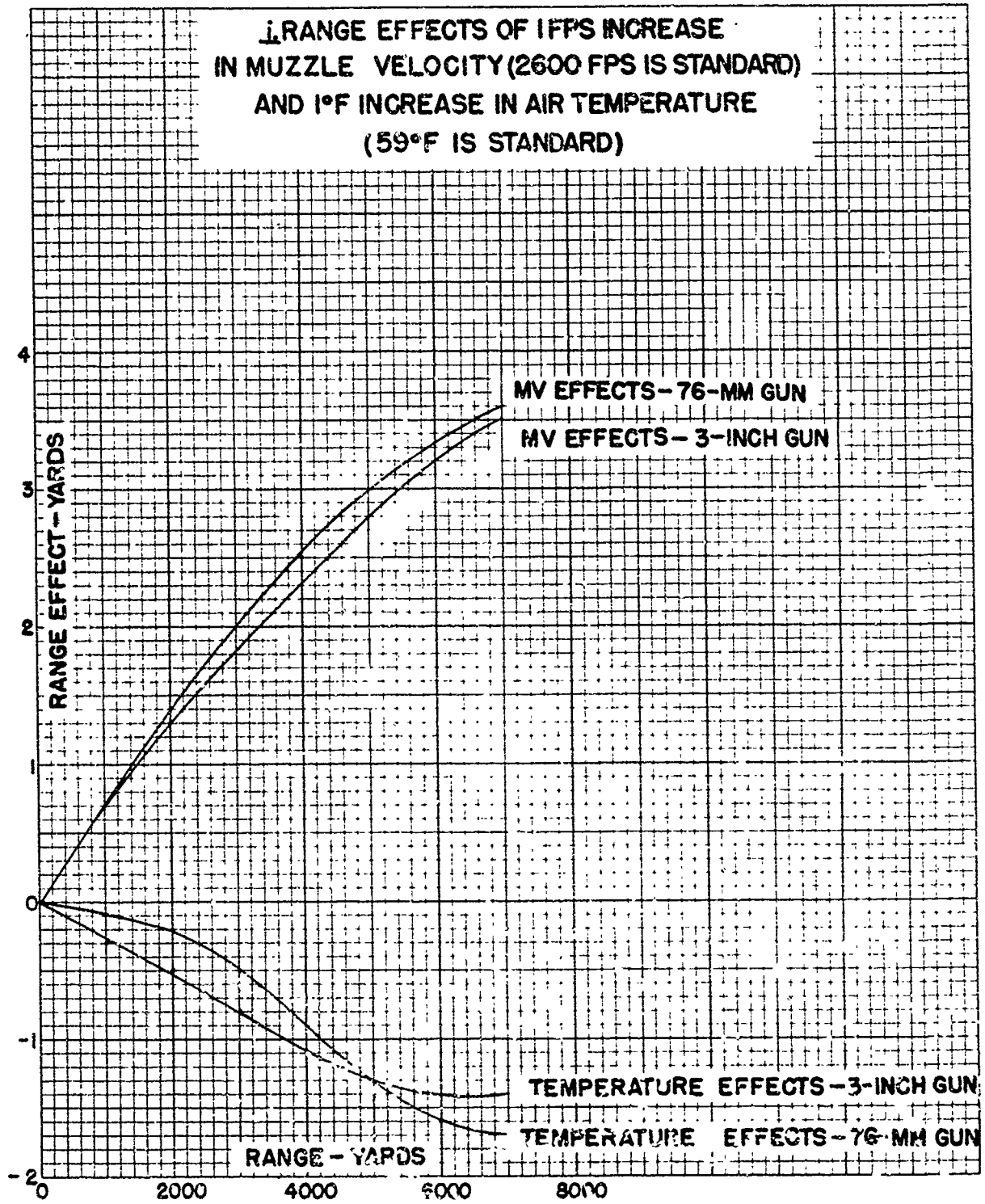

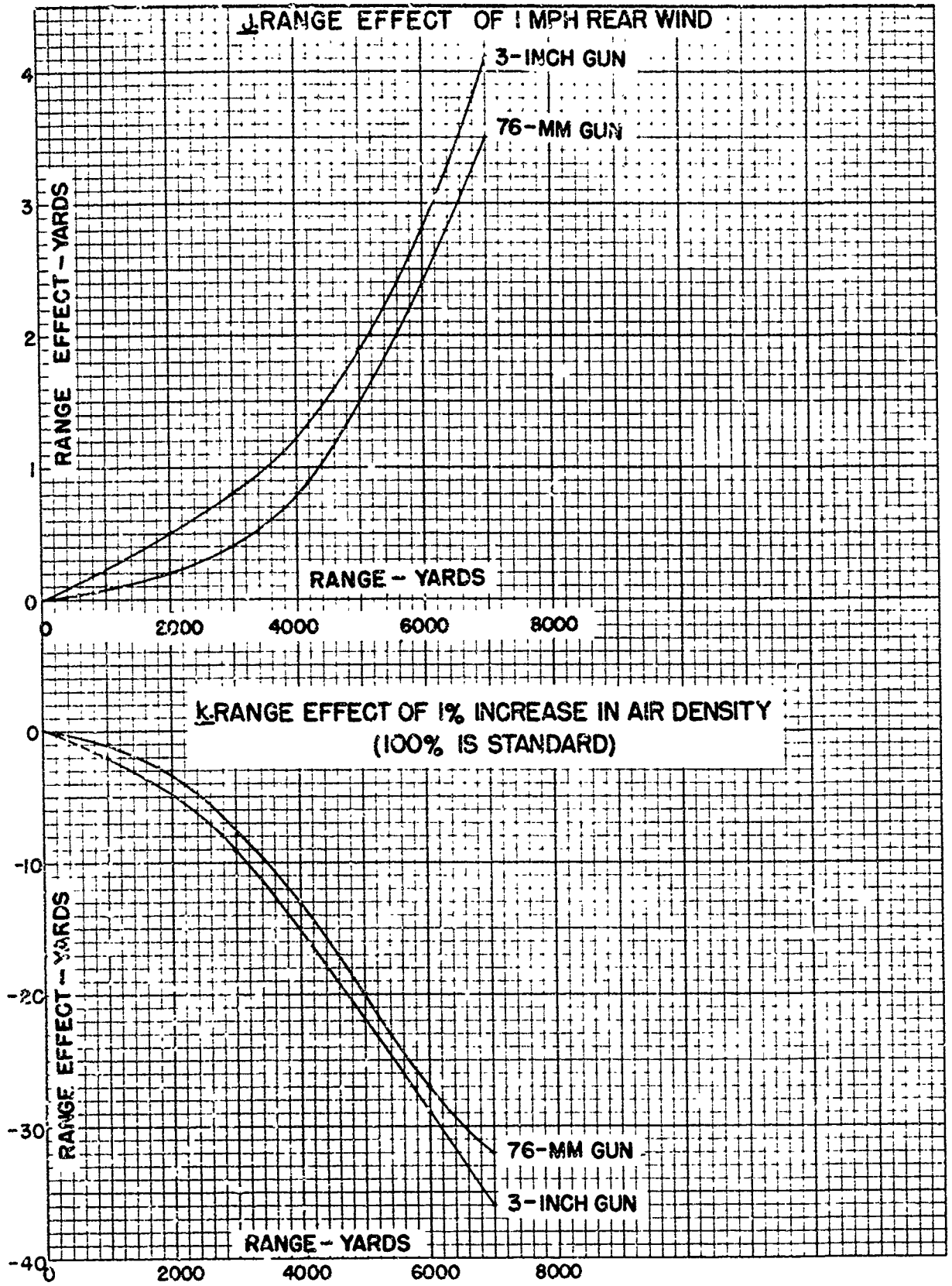

SECTION V
EFFECT DATA

Paragraph

Penetration - - - - - 8

8. Penetration.**a. Ballistic Limits of Armor Plate.**

Type	Plate		Ballistic Limit		Number in Average
	Thickness inches	Obliquity degrees	Type	fps	
Face	3	20	Navy	1742	26
Hardened	3	30	Navy	2027	1
Homo- geneous	3	20	Army	1726	2
	3	20	Navy	1852	2
	4	30	Navy	2391	1

b. Vulnerability of German Tanks (Panzerkampfwagen)

MV: 2600 fps. These data were taken from TM9-1907, "Ballistic Data, Performance of Ammunition".

Maximum Vulnerable Range - yd.

Tank Model		III		IV		VI	
Attack	Angle - deg	0	25	0	25	0	25
Frontal	Turret Sides	5000+	5000+	5000+	5000+	2880	720
	Turret Rear	----	----	----	----	2880	720
	Turret Front	4020	2930	4220	3080	*	*
	Upper Hull Front	3230	1740	3300	1740	1020	*
	Lower Hull Front	2600	1180	3040	1600	*	*
Flank	Turret Sides	5000+	5000+	5000+	5000	2880	720
	Turret Rear	5000+	5000+	5000+	5000+	2880	720
	Turret Front	4020	2930	4220	3080	*	*
	Upper Hull Sides	5000+	5000+	5000+	5000+	2880	720
	Lower Hull Sides	5000+	5000+	5000+	5000+	3980	3000
Rear	Turret Sides	5000+	5000+	5000+	5000+	2880	720
	Turret Rear	5000+	5000+	5000+	5000+	2880	720
	Turret Front	4020	2930	4220	3080	*	*
	Upper Hull Rear	3900	2860	5000+	5000+	2200	550
	Lower Hull Rear	4220	3080	5000+	5000+	2200	550

*Not vulnerable.

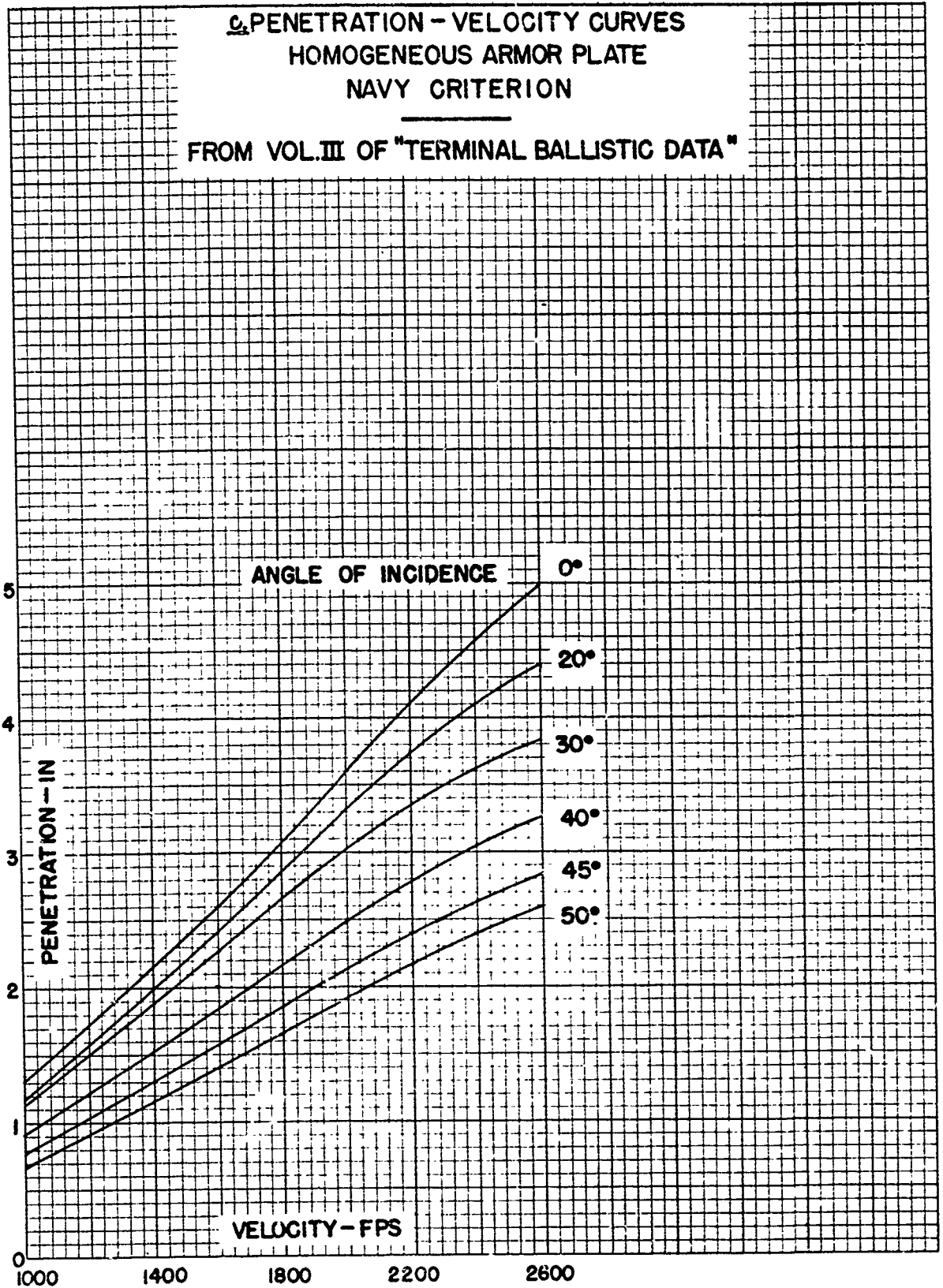

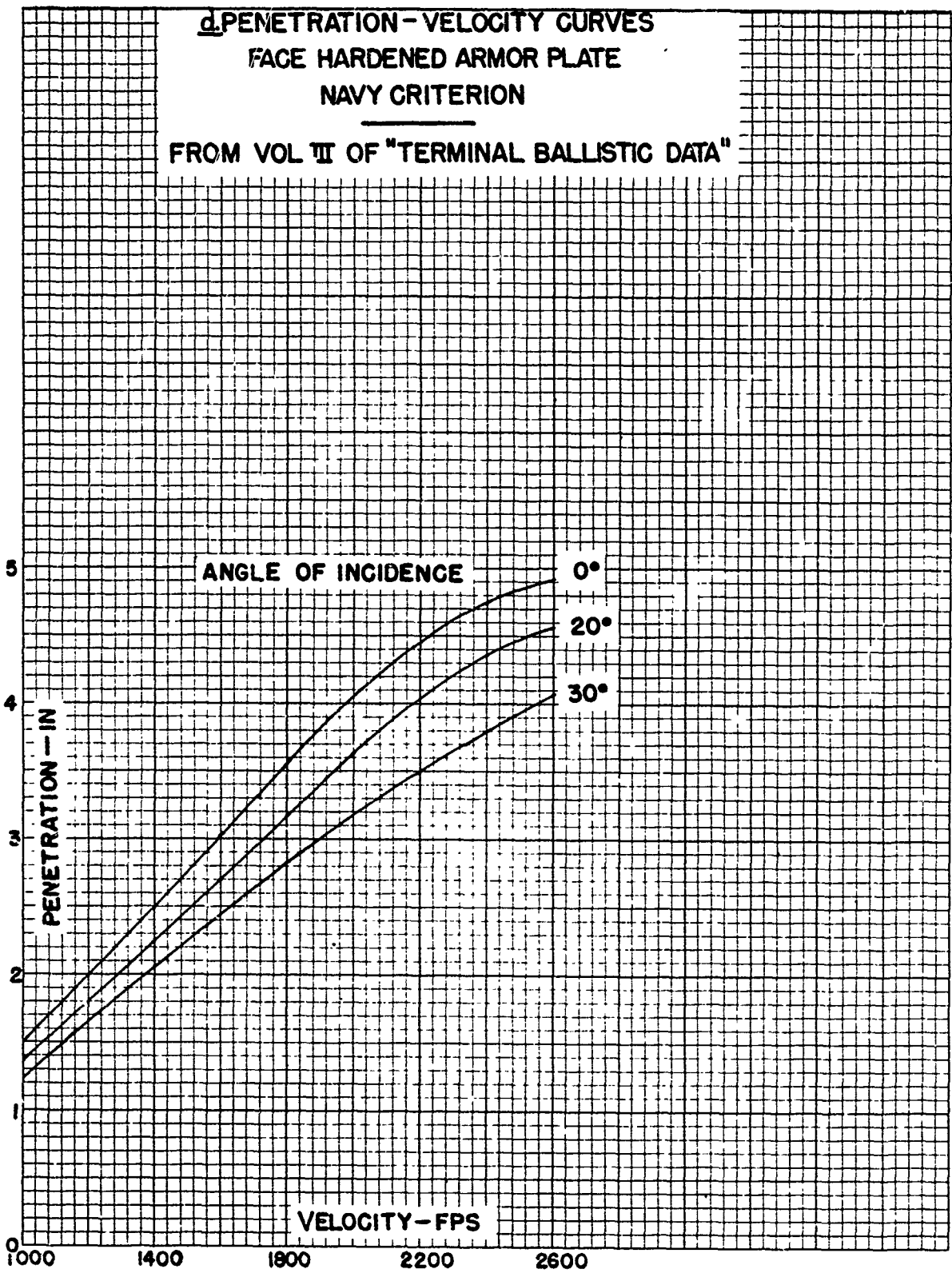

**2. TOTAL NUMBER OF ROUNDS NECESSARY
TO OBTAIN 90% PROBABILITY OF AT LEAST
ONE PERFORATION IN TARGETS OF
GRADE A CONCRETE (5000 PSI)
MV 2600 FPS**

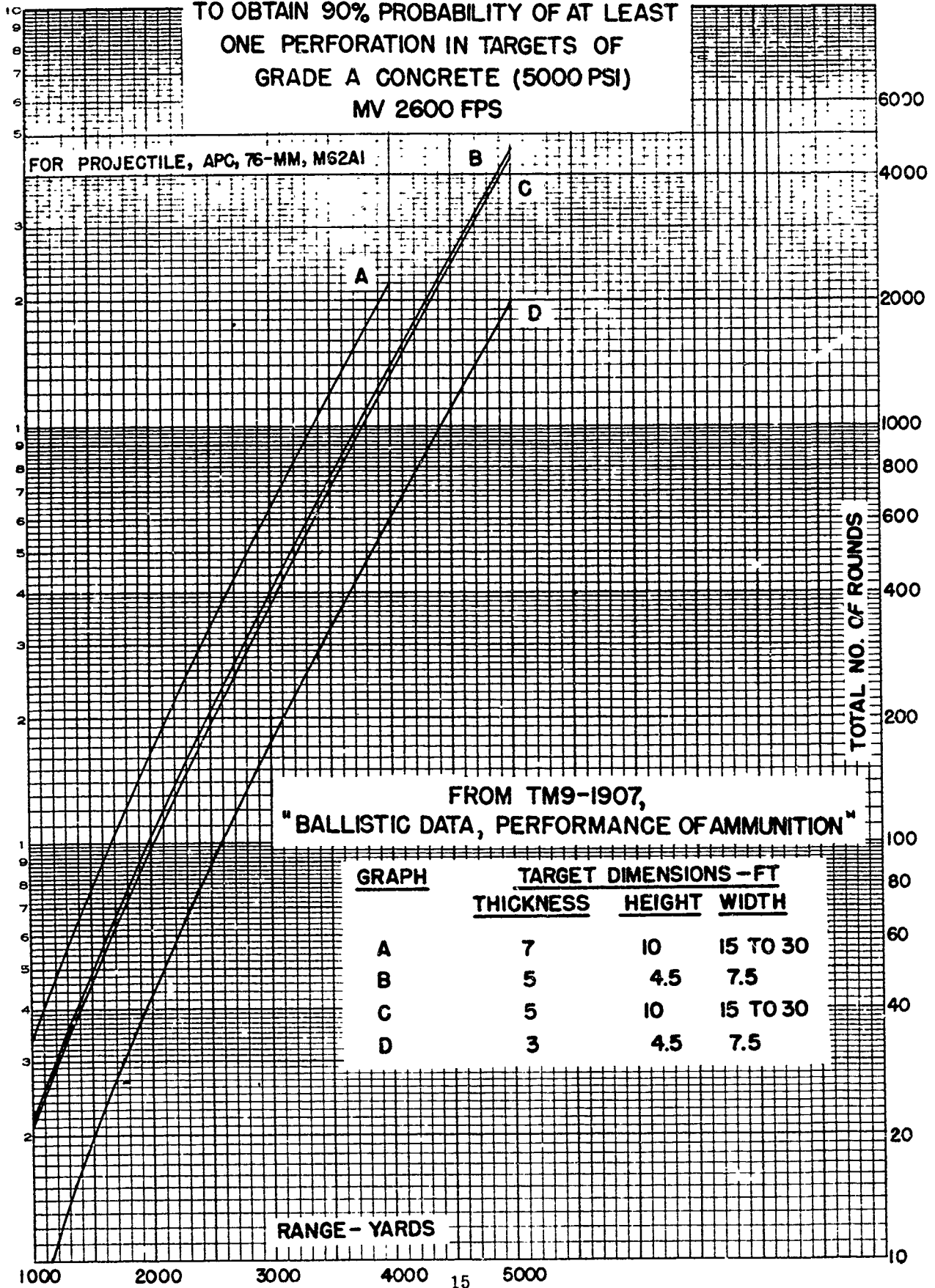

f. Total Number of Rounds Necessary to Obtain 90% Probability of Enough Hits to Make a Breach
12 Ft Wide in a Concrete Wall 10 Ft High. From TM 9-1907, "Ballistic Data, Performance of Ammunition".

MV 2600 fps
Range 1000 yd

Wall thickness	6 ft	10 ft
No. of rounds	100	180

Ballistic Research Laboratories
Handbook of Ballistic and
Engineering Data for Ammunition,
No. 76-1-79

Ballistic Research Lab.
Aberdeen Proving Ground,
Maryland.
4 February 1949

BALLISTIC AND ENGINEERING DATA
for
Shot, AP, 76-mm (3-inch), M79 with Tracer

<u>Section</u>	<u>Paragraph</u>
I General -----	1
II Description -----	2 - 4
III Interior ballistic data -----	5
IV Exterior ballistic data -----	6 - 7
V Effect data -----	8

**SECTION I
GENERAL**

	<u>Paragraph</u>
Purpose - - - - -	1

1. **Purpose.** The purpose of this number of the handbook is to furnish a concise collection of information regarding the shape, dynamics, ballistics and effects of the 76-mm (3-inch) Armor-piercing Shot M79 with Tracer. This information is collected from the drawings, reports, and firing tables pertaining to this ammunition.

**SECTION II
DESCRIPTION**

	<u>Paragraph</u>
Drawing - - - - -	2
Dimensions - - - - -	3
Physical characteristics - - - - -	4

ALL MEASUREMENTS IN CALIBERS
1 CAL = 3.000"

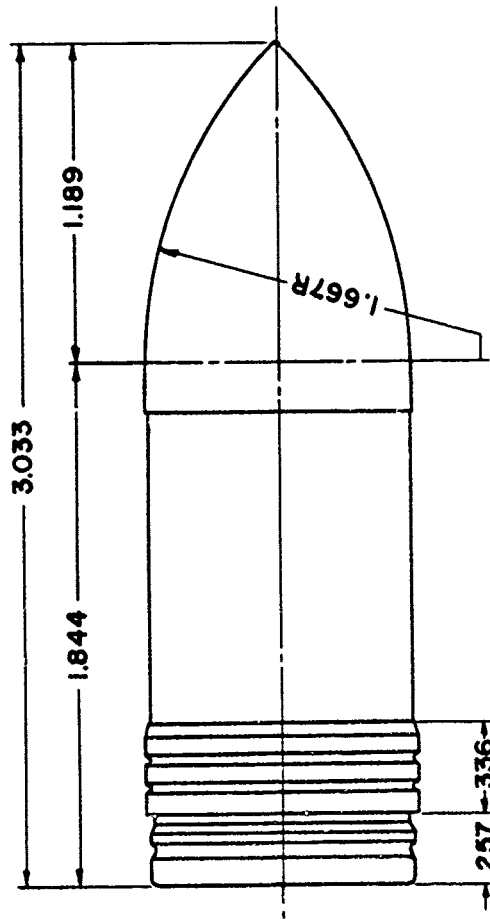

SHOT, AP, 76-MM, M79

2. Drawing.

Shot: Metal parts assembly and details 75-18-45

3. Dimensions.

Band: Distance from base 0.257 cal
Width 0.336 cal

Cylindrical body: Length 1.844 cal

Ogive: Length 1.189 cal
Radius of arc 1.667 cal

Shot: Total Length 3.033 cal

4. Physical characteristics.

Weight (standard) 15.00 lb
Base to center of gravity* 1.33 cal
Axial moment of inertia* 15.90 lb.in²
Transverse moment of inertia* 81.85 lb.in²

*Estimated on the basis of measurements of the 37-mm AP Shot M80.

SECTION III

INTERIC BALLISTIC DATA

Theoretical yaw in bore - - - - - Paragraph
5

5. Theoretical yaw in bore.

Minimum 8 min
Maximum 12 min

SECTION IV

EXTERIOR BALLISTIC DATA

Aerodynamic data - - - - - Paragraph 6
Firing table data - - - - - 7

6. Aerodynamic data.

a. Drag. A form factor of 1.05 relative to Projectile Type 1 was determined from resistance firings at a muzzle velocity of 2600 fps. The corresponding ballistic coefficient is 1.59 on the G_1 drag function. The drag coefficient is 0.229 at 2600 fps.

b. Stability. No stability firings have been conducted with the 76-mm AP Shot M79. The stability factor estimated from that of the 37-mm Armor-piercing Shot M80 (Ballistic Research Laboratory Report 438, "Yaw and Drift of 37-mm Armor-piercing Shots") at a muzzle velocity of 2600 fps and a twist of rifling of one turn in 40 calibers is 3.4.

7. Firing table data.

Gun	76-mm M1A2 (Tank)	3-inch M5 (Antitank)
Twist of rifling	1/32	1/40
Muzzle velocity	2600 fps	2600 fps
FT	76-A-6 (p. 18)	3-T-1 (Abridged)

OCM items 17458 and 17523 recommended and approved classification of the 3-inch AP Shot M79 as substitute standard (the APC Projectile M62, which is more difficult to manufacture, is standard). OCM items 19052 and 19204 recommended and approved its use in the 76-mm Gun M1. The 76-mm Guns M1 and M1A1, with 1/40 twist, are now obsolete.

a. Form factor (Projectile Type 1): $i_1 = 1.05$.

b. Ballistic coefficient (Projectile Type 1): $C_1 = 1.59$.

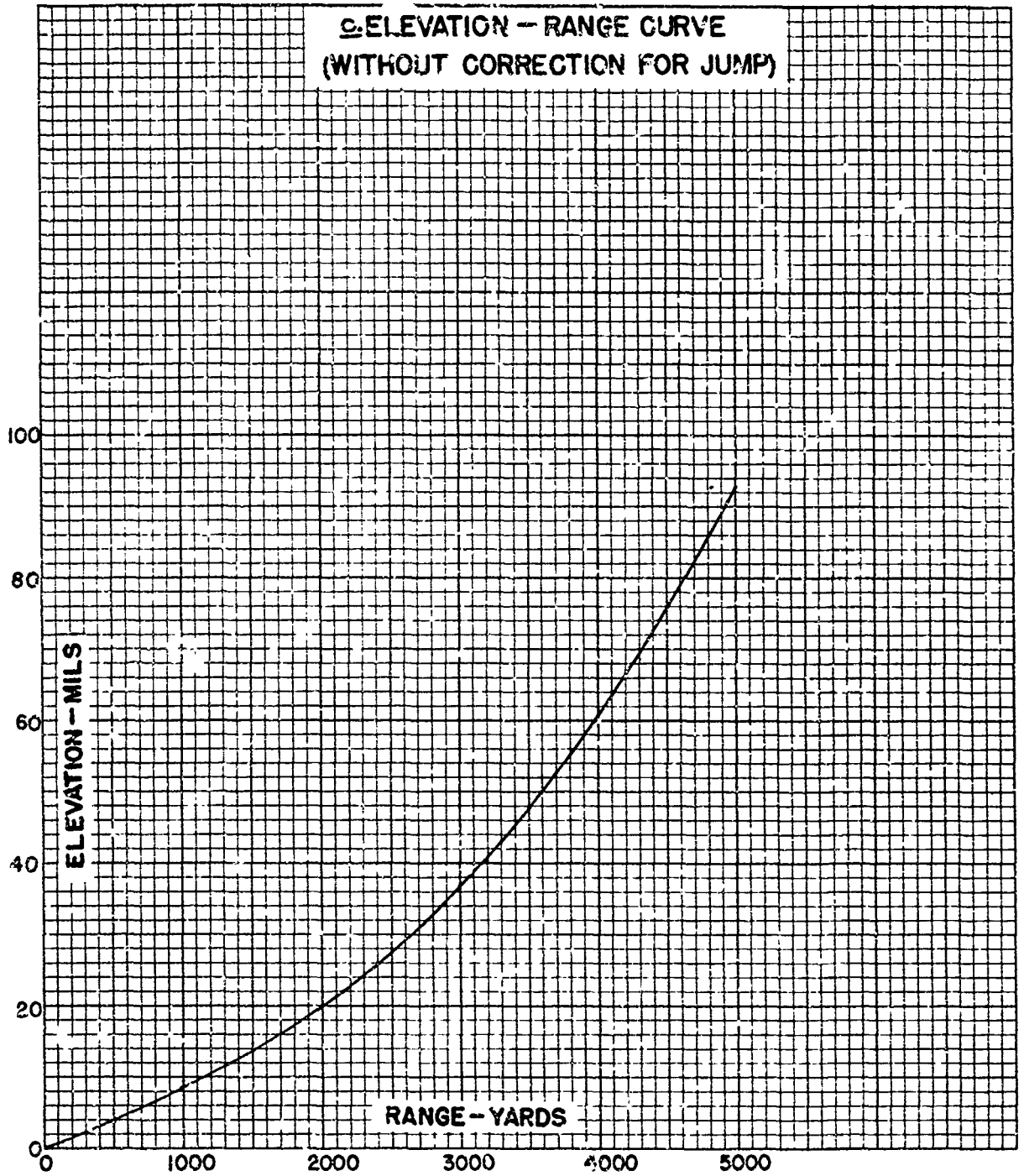

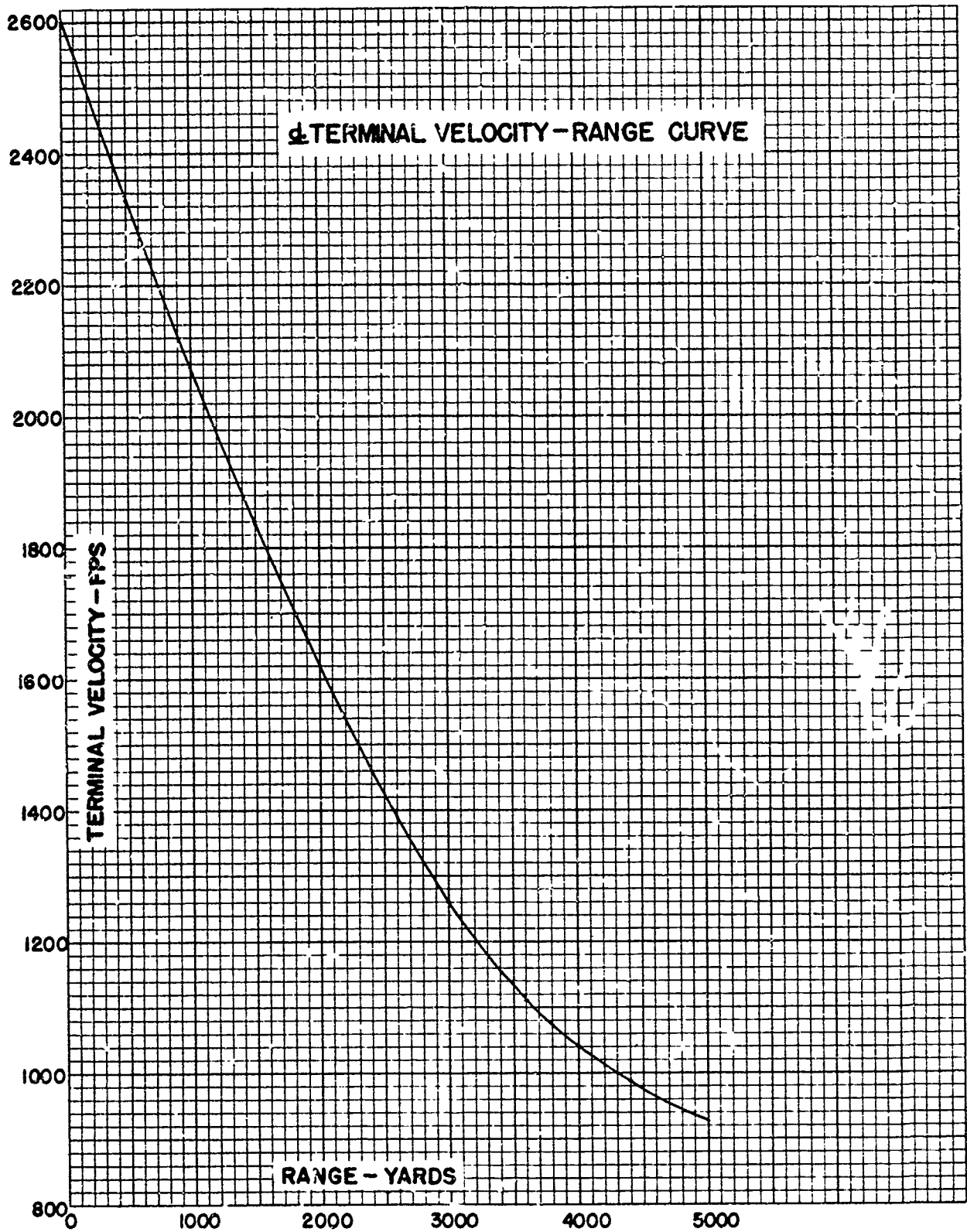

SECTION V
EFFECT DATA

Penetration - - - - - Paragraph
8

8. Penetration.

BALLISTIC LIMITS OF ARMOR PLATE

<u>Homogeneous Plate</u>		<u>Ballistic Limit</u>		<u>Number in Average</u>
<u>Thickness inches</u>	<u>Obliquity degrees</u>	<u>Type</u>	<u>fps</u>	
3	0	Army	1356	2
4	0	Army	1719	1
3	0	Navy	1512	2
4	0	Navy	1911	1

Ballistic Research Laboratories
Handbook of Ballistic and
Engineering Data for Ammunition,
No. 76-1-93.

Ballistic Research Lab.
Aberdeen Proving Ground,
Maryland.
3 February 1949

BALLISTIC AND ENGINEERING DATA
for
Shot, HVAP, 76-mm, M93 with Tracer

<u>Section</u>	<u>Paragraphs</u>
I General -----	1
II Description -----	2 - 4
III Interior ballistic data -----	5
IV Exterior ballistic data -----	6 - 7
V Effect data -----	8

**SECTION I
GENERAL**

	<u>Paragraph</u>
Purpose - - - - -	1

1. **Purpose.** The purpose of this number of the handbook is to furnish a concise collection of information regarding the shape, dynamics, ballistics and effects of the 76-mm Hypervelocity Armor-piercing Shot M93 with Tracer. This information is collected from the drawings, reports, and firing tables pertaining to this ammunition and to earlier experimental models of the T4 series (the M93 Shot was designated T4F20).

**SECTION II
DESCRIPTION**

	<u>Paragraph</u>
Drawings - - - - -	2
Dimensions - - - - -	3
Physical characteristics - - - - -	4

ALL DIMENSIONS IN CALIBERS
1 CAL = 3.000 IN.

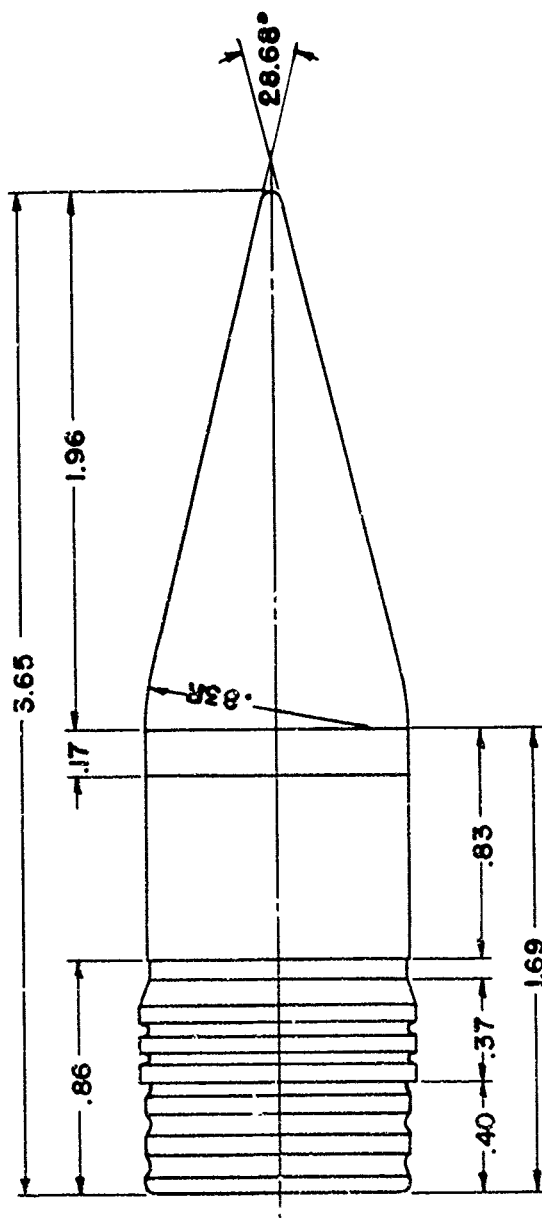

SHOT, HVAR, 76-MM, M93

2. Drawings.

Metal parts assembly	75-2-361
Metal parts details	75-2-362 and 363

3. Dimensions.

Band: Distance from base	0.40 cal
Width	0.37 cal
Base and body: Length of base	0.86 cal
Length of body and bourrelet	0.83 cal
Length of bourrelet ring	0.17 cal
Length of base, body and bourrelet	1.69 cal
Windshield: Length	1.96 cal
Radius of arc	0.83 cal
Vertical angle of cone	28.68 deg
Shot: Total length	3.65 cal
Core: Diameter	1.50 in

4. Physical characteristics.

Weight of shot with tracer	9.31 lb
Weight of shot without tracer	9.30 lb
Weight of core	3.95 lb
Base to center of gravity*	1.178 cal ²
Axial moment of inertia*	8.54 lb. in ²
Transverse moment of inertia*	44.2 lb. in ²

*Calculated from the dimensions of the HVAP Shot T4E1, which is approximately the same shape as the M93 Shot, but weighs 9.97 lb and has a 3.98-lb core.

**SECTION III
INTERIOR BALLISTIC DATA**

Theoretical yaw in bore - - - - -	<u>Paragraph</u> 5
-----------------------------------	-----------------------

5. Theoretical yaw in bore.

Minimum	8.5 min
Maximum	13.6 min

SECTION IV
EXTERIOR BALLISTIC DATA

	<u>Paragraph</u>
Aerodynamic data - - - - -	6
Firing table data - - - - -	7

6. Aerodynamic data.

a. Drag.

	T4E17	M93
Shot	T4E17	M93
Drag function	G_8	G_8
Muzzle velocity	3400 fps	3400 fps
Form factor (i_g)	1.175	1.165
Ballistic coefficient (C_g)	0.879	0.888
Drag coefficient (K_D)	0.111	0.110

b. Stability.

	T4E17	
Shot	T4E17	
Muzzle Velocity	3440 fps	
Moment coefficient (K_M)	0.67	
Gun, 76-mm	M1A1	M1A2
Twist of rifling	1/40	1/32
Stability factor	1.44	2.25

7. Firing table data. FT 76-C-1. MV 3400 fps.

Gun, 76-mm, M1A2. Twist of rifling: 1/32. The 76-mm Guns M1 and M1A1, with 1/40 twist, are now obsolete.

Standardization of the 76-mm HVAP Shot M93 with Tracer was recommended by OCM item 26551 and approved by OCM item 26841.

a. Form factor (Projectile Type 8): $i_g = 1.175$

This value was determined by resistance firings of the AP Shot T4E17 with a mean instrumental velocity of 3337 fps.

b. Ballistic coefficient (Proj Type 8): $C_g = 0.879$.

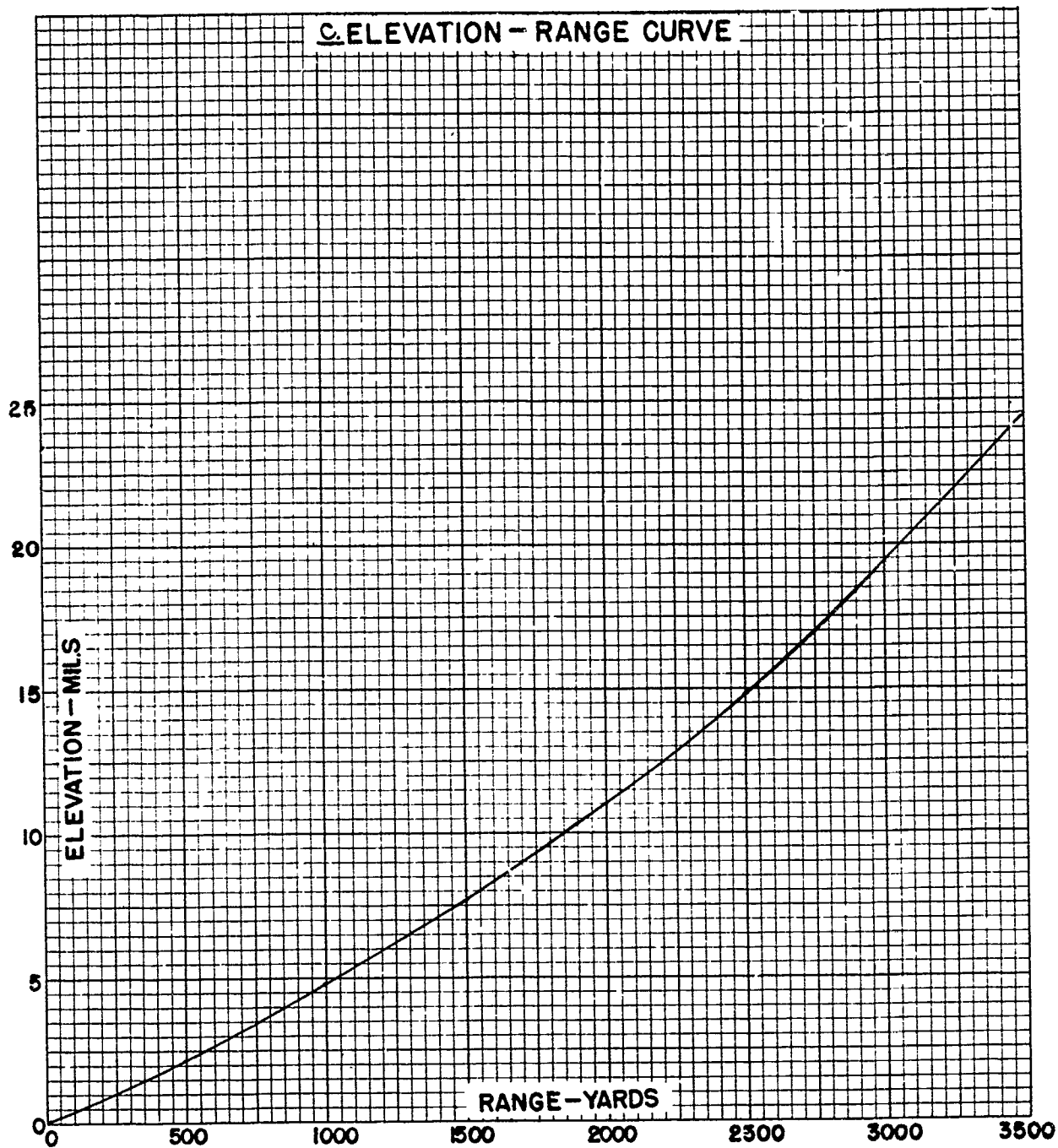

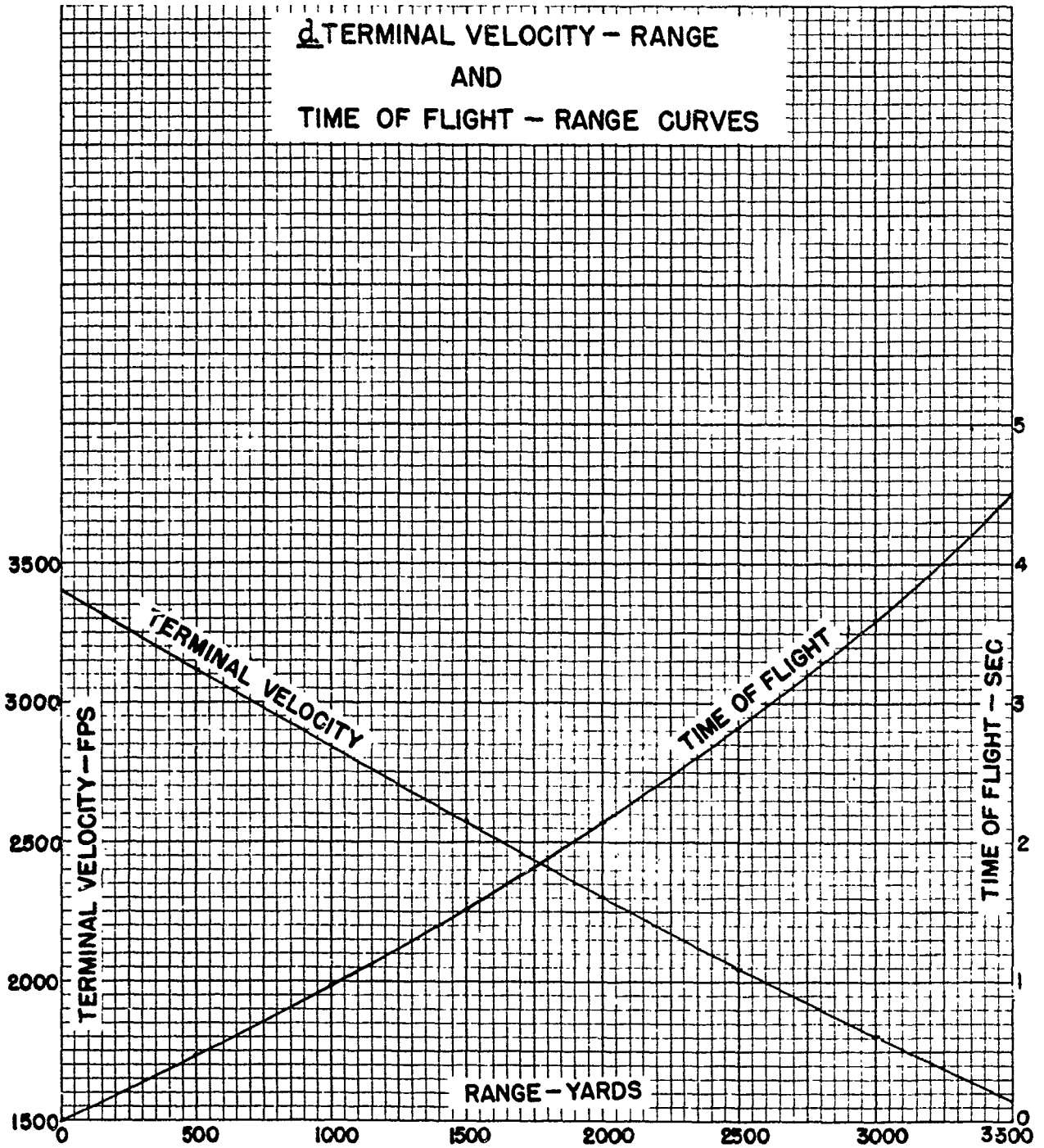

SECTION V
EFFECT DATA

Penetration - - - - - Paragraph
8

8. **Penetration.** The chart on page 8 was taken from Ballistic Research Laboratory Report No. 533, "Penetration of Armor by 76-mm and 90-mm HVAP Projectiles".

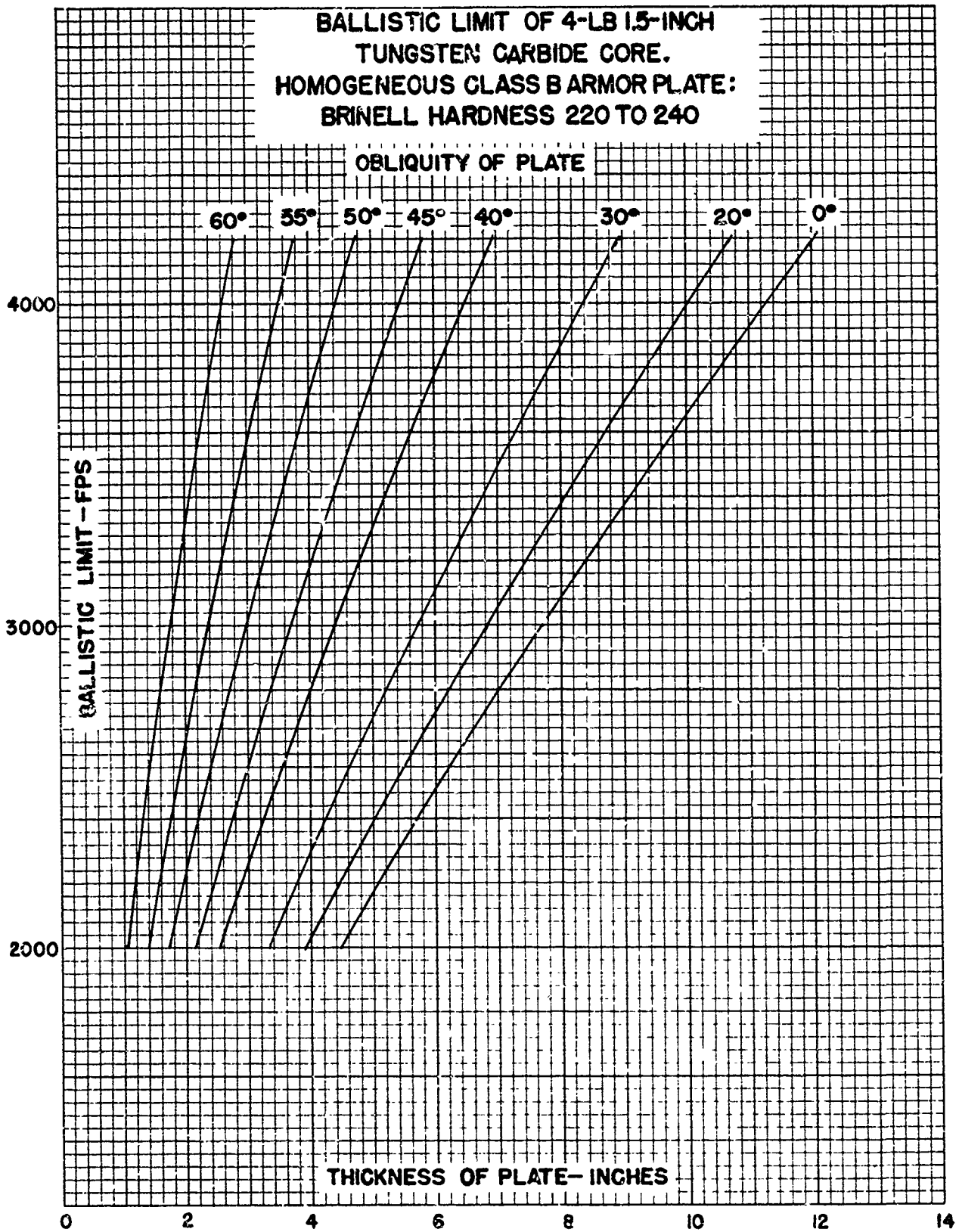

Ballistic Research Laboratories
 Handbook of Ballistic and
 Engineering Data for Ammunition,
 No. 81-1-43

Ballistic Research Lab.
 Aberdeen Proving Ground,
 Maryland
 4 February 1949

BALLISTIC AND ENGINEERING DATA

for

Shell, HE, 81-mm, M43 and M43A1

with

Fuze, PD, M45, M52 and M52A1

<u>Section</u>		<u>Paragraph</u>
I	General -----	1
II	Description -----	2 - 4
III	Exterior ballistic data-----	5 - 6
IV	Effect data -----	7

SECTION I

GENERAL

	<u>Paragraph</u>
Purpose - - - - -	1

1. **Purpose.** The purpose of this number of the handbook is to furnish a concise collection of information regarding the shape, dynamics, ballistics and effects of the 81-mm High Explosive Shell M43 with the Point Detonating Fuze M45 and the 81-mm High Explosive Shell M43A1 with the Point Detonating Fuze M52 or M52A1. This information is collected from the drawings, reports, firing tables, and technical manuals pertaining to this ammunition.

SECTION II

DESCRIPTION

	<u>Paragraph</u>
Drawings - - - - -	2
Dimensions - - - - -	3
Physical characteristics - - - - -	4

ALL DIMENSIONS IN CALIBERS
1 CALIBER = 3.189"

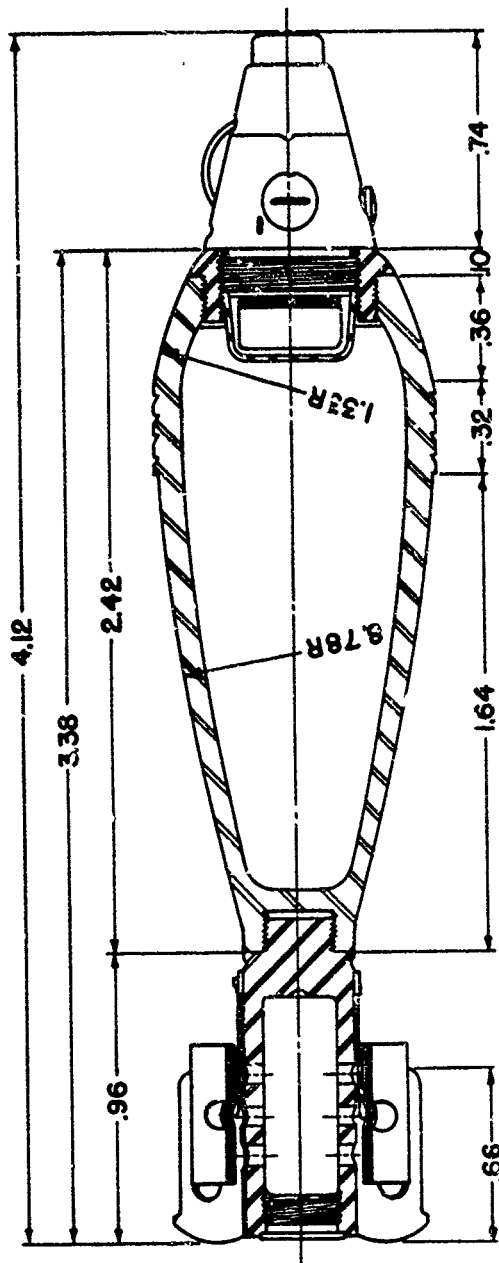

SHELL, HE, 81-MM, M43A1
FUZE, PD, M52

2. Drawings.

Complete round, HE Shell M43 with PD Fuze M45: Assembly and marking diagram	75-1-47
Complete round, HE Shell M43A1 with PD Fuze M52: Assembly and marking diagram	75-1-88
Shell: Metal parts assembly and details	75-2-261
Fins: Assembly and details	75-2-262
PD Fuze M45: Assembly	73-1-143
PD Fuze M52 or M52A1: Assembly and details	73-1-161

3. Dimensions.

Fins: Number	6
Length (omitting front slope)	0.66 cal
Length of assembly (outside)	0.96 cal
Shell: Radius of arc behind bourrelet	8.78 cal
Radius of arc in front of bourrelet	1.33 cal
Length of rear part	1.64 cal
Length of bourrelet	0.32 cal
Length of front part	0.36 cal
Length of adapter (outside)	0.10 cal
Total length	2.42 cal
Fuze: M45, outside length	0.73 cal
M52, outside length	0.74 cal
Length: Shell and fin assembly	3.38 cal
Shell, fin assembly, and fuze M45	4.11 cal
Shell, fin assembly, and fuze M52	4.12 cal

4. Physical characteristics.

Weight (standard)	6.92 lb
Center of gravity to point of fuze	1.92 cal
Transverse moment of inertia	68.97·lb.in ²

SECTION III
EXTERIOR BALLISTIC DATA

	<u>Paragraph</u>
Aerodynamic data - - - - -	5
Firing table data - - - - -	6

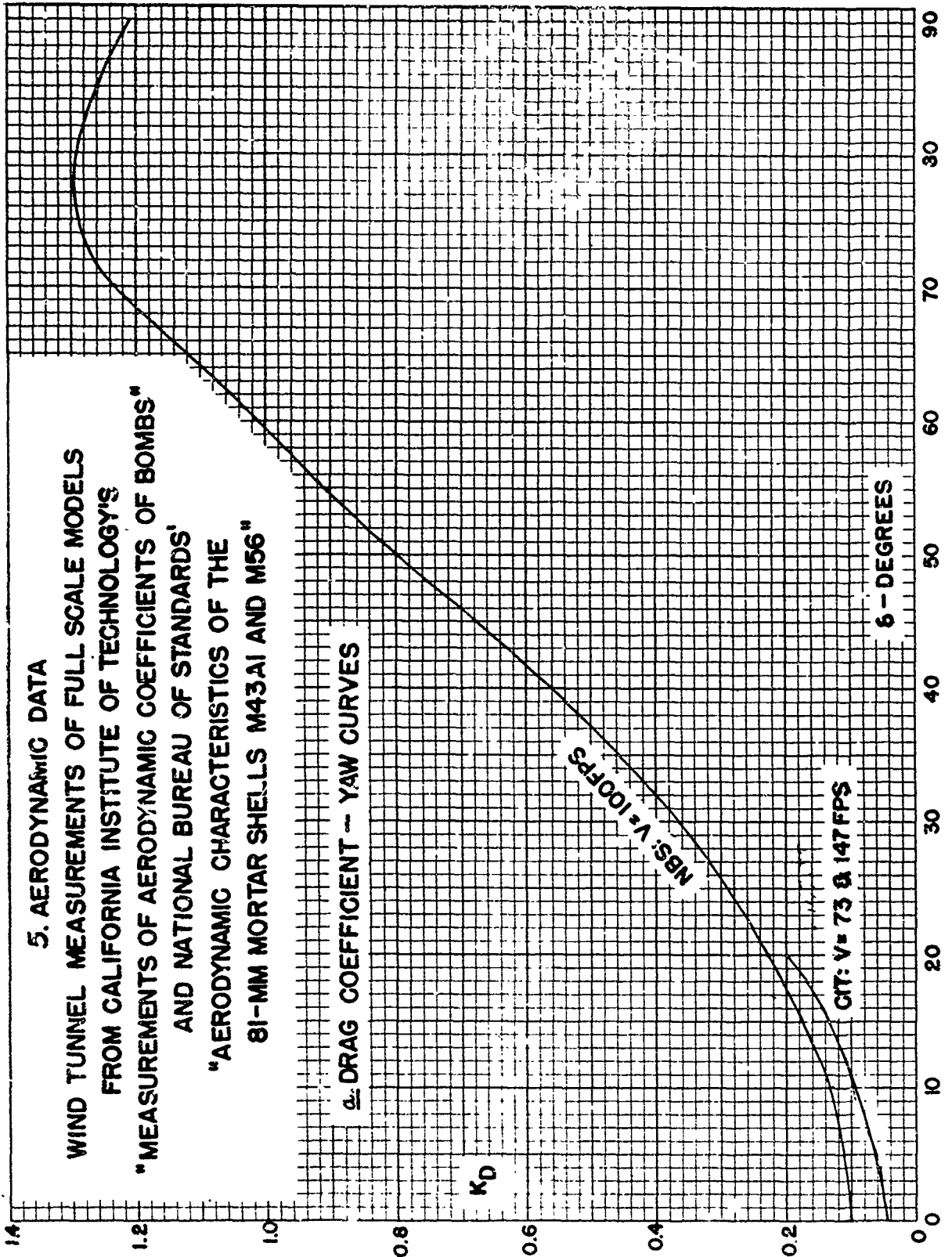

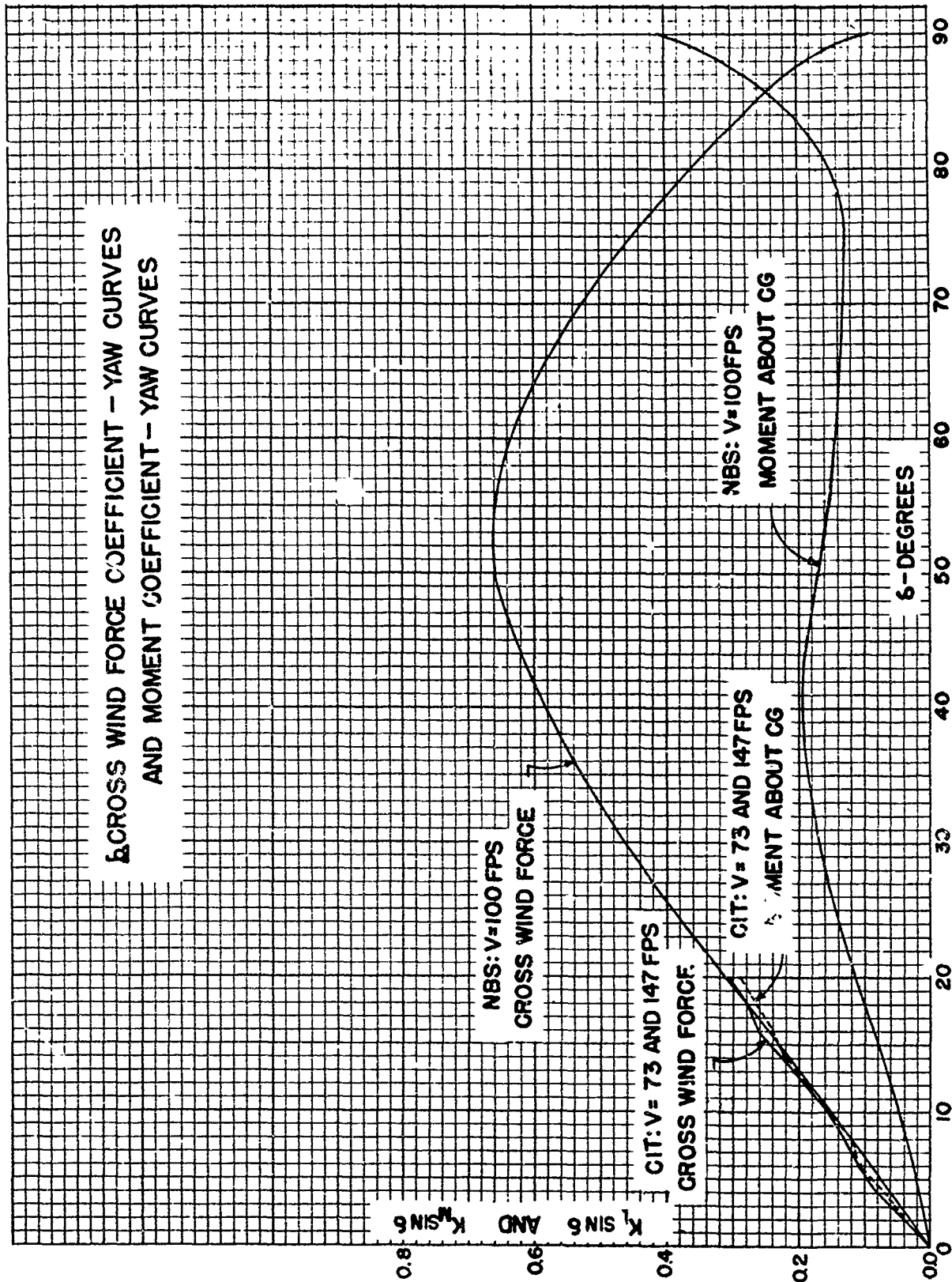

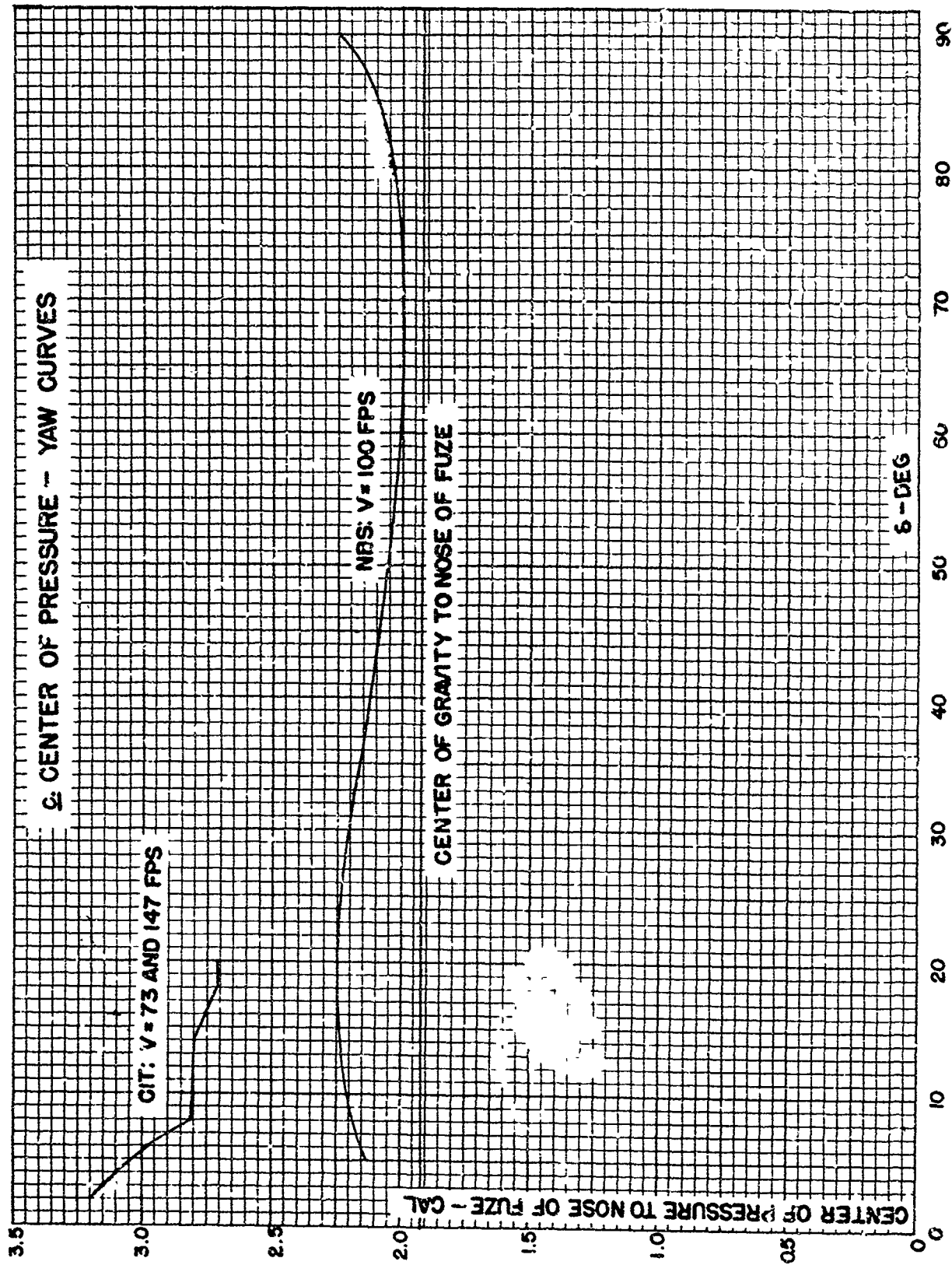

6. Firing table data.

FT 81-B-2 and FT 81-B-4 (abridged).

Mortars, 81-mm, M1 and M21; Mortar, Trench, 3-inch, Mark IA2. Smooth bore: muzzle loading. Projectile weight: 6.87 lb. OCM items 9909 and 10024 recommended and approved standardization of the HE Shell M43 for the 81-mm Mortar M1. OCM items 11703 and 11767 recommended and approved standardization of the HE Shell M43 for the 3-inch Trench Mortar Mark IA2 with charges 0 to 4, but not with the larger charges. OCM items 28162 and 28822 recommended and approved standardization of the HE Shell M43 for the 81-mm Mortar M21; OCM Item 31408 restandardized it after further development of the mortar. FT 81-R-1 (abridged) is a range-elevation table for the 81-mm Mortar T27, which is the M21 Mortar without the Extension Tube and is used with charges 0 to 3 at short ranges.

a. **Form factor data.** The following form factors relative to Projectile Type 1 were determined from the ranges tabulated in FT 81-B-2 for an elevation of 45°.

<u>Charge</u>	<u>Muzzle Velocity</u> fps	<u>Form Factor</u> f_1
0	235	.55
1	332	.69
2	419	.78
3	499	.72
4	572	.75
5	638	.77
6	700	.84

b. **Ballistic coefficient data.** The following ballistic coefficients relative to Projectile Type 1 were determined from the ranges tabulated in FT 81-B-2 for an elevation of 45°.

<u>Charge</u>	<u>Muzzle Velocity</u> fps	<u>Ballistic Coefficient</u> C_1
0	235	1.230
1	332	0.984
2	419	0.861
3	499	0.944
4	572	0.906
5	638	0.881
6	700	0.802

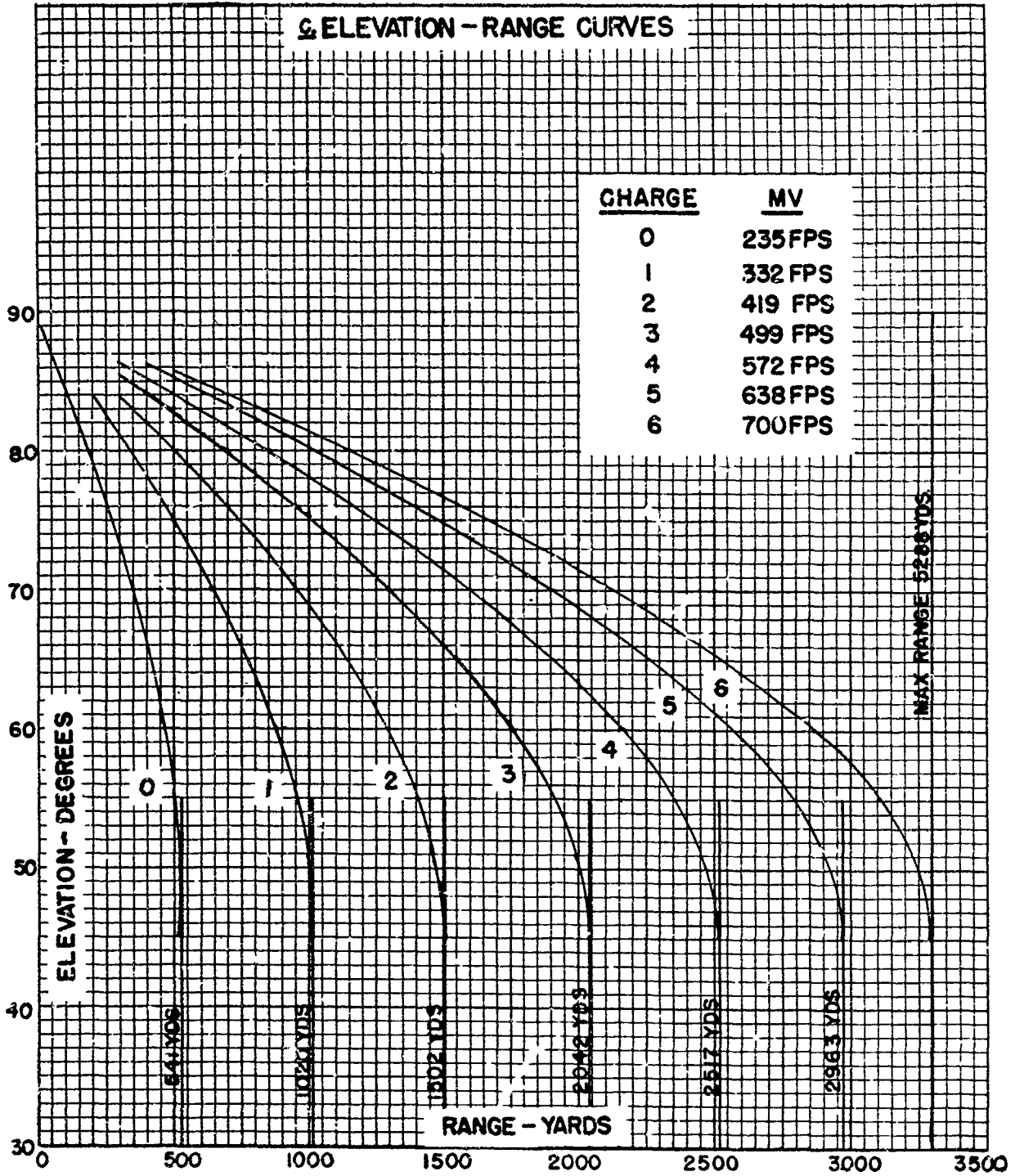

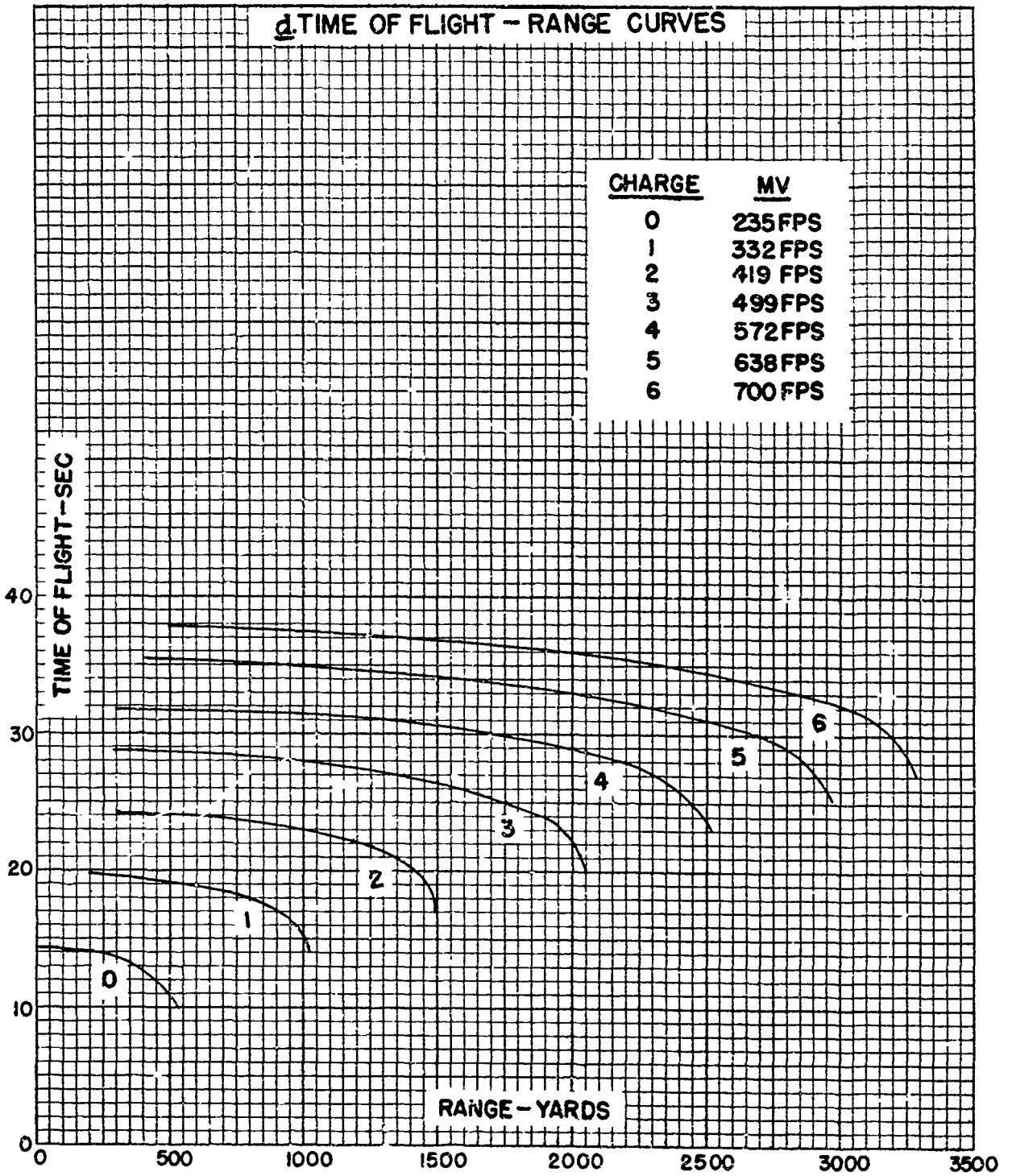

**SECTION IV
EFFECT DATA**

Paragraph

Fragmentation - - - - - 7

7. Fragmentation. The data on fragmentation of 81-mm HE Shell M43A1 were taken from "Terminal Ballistic Data", Vol. III. The initial fragment velocity is 3,930 fps.

a. Casualties.

TABLE 42
CASUALTIES

Distance from burst (ft)	Total number of effective fragments	Average number of effective frag- ments per sq ft	For the lightest effective fragment	
			Weight (oz)	Velocity (fps)
r	N	B	m	v
20	818	0.183	0.009	2570
30	695	0.0615	0.014	2060
50	645	0.0321	0.017	1870
60	541	0.0120	0.027	1480
80	459	0.0057	0.038	1250
100	384	0.0031	0.051	1080
150	267	0.0009	0.077	880
200	169	0.0003	0.104	758
300	76	0.0001	0.159	611

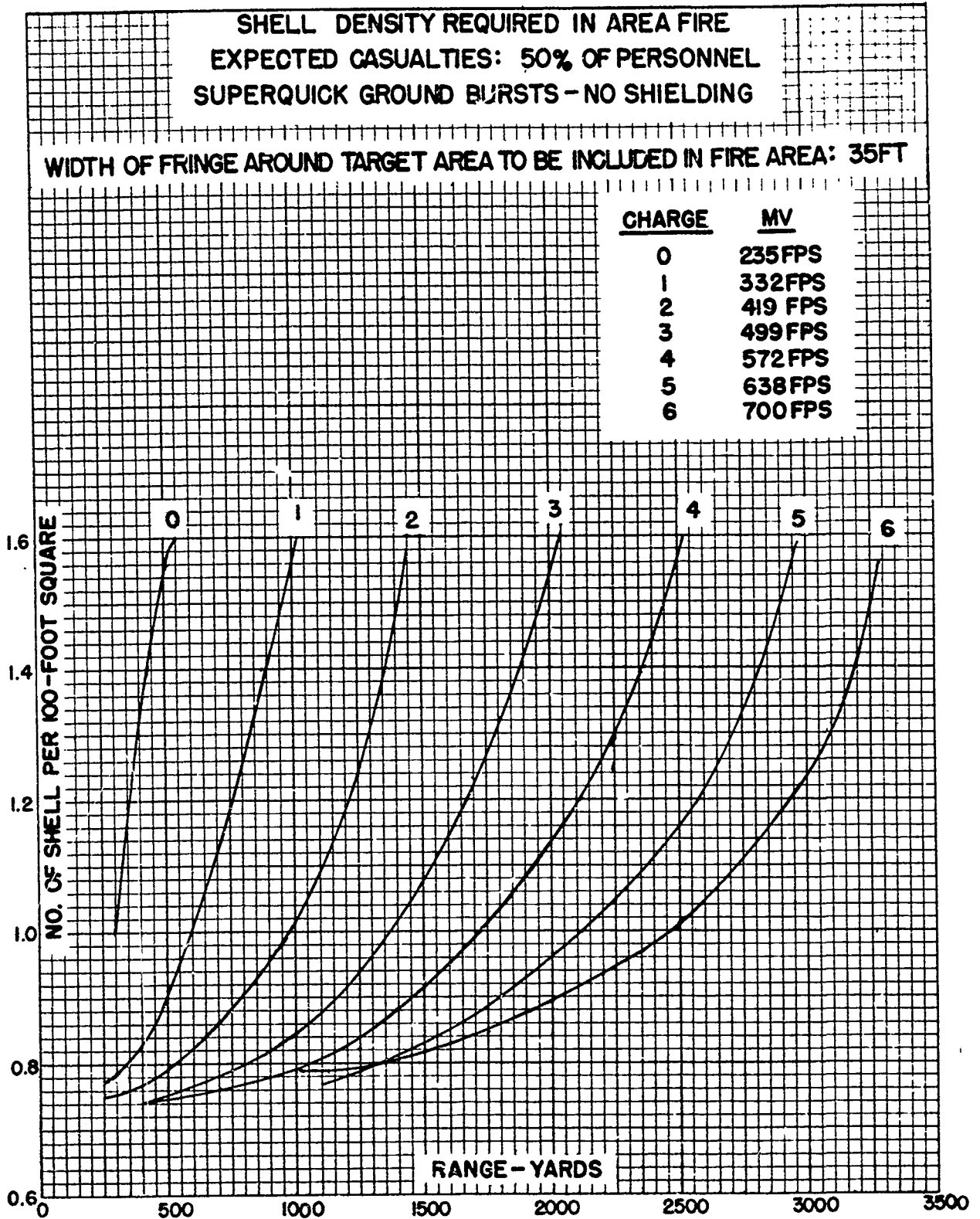

b. Perforation of 1/8-inch mild steel.

TABLE 43
PERFORATION OF 1/8 IN. MILD STEEL

Distance from burst (ft)	Total number of effective fragments	Average number of effective frag- ments per sq ft	For the lightest effective fragment	
			Weight (oz)	Velocity (fps)
r	N	B	m	v
20	541	0.108	0.027	2970
30	473	0.0418	0.036	2670
40	407	0.0202	0.047	2430
60	282	0.0062	0.073	2090
80	164	0.0020	0.105	1870
100	88	0.0007	0.146	1720
120	58	0.0003	0.197	1530
140	40	0.0002	0.258	1420
180	23	0.0001	0.399	1240

**SHELL DENSITY REQUIRED IN AREA FIRE
 EXPECTED PERFORATIONS OF 1/8-INCH MILD STEEL:
 50% OF ELEMENTS 2 SQ FT IN AREA
 SUPERQUICK GROUND BURSTS - NO SHIELDING**

WIDTH OF FRINGE AROUND TARGET AREA TO BE INCLUDED IN FIRE AREA: 21 FT

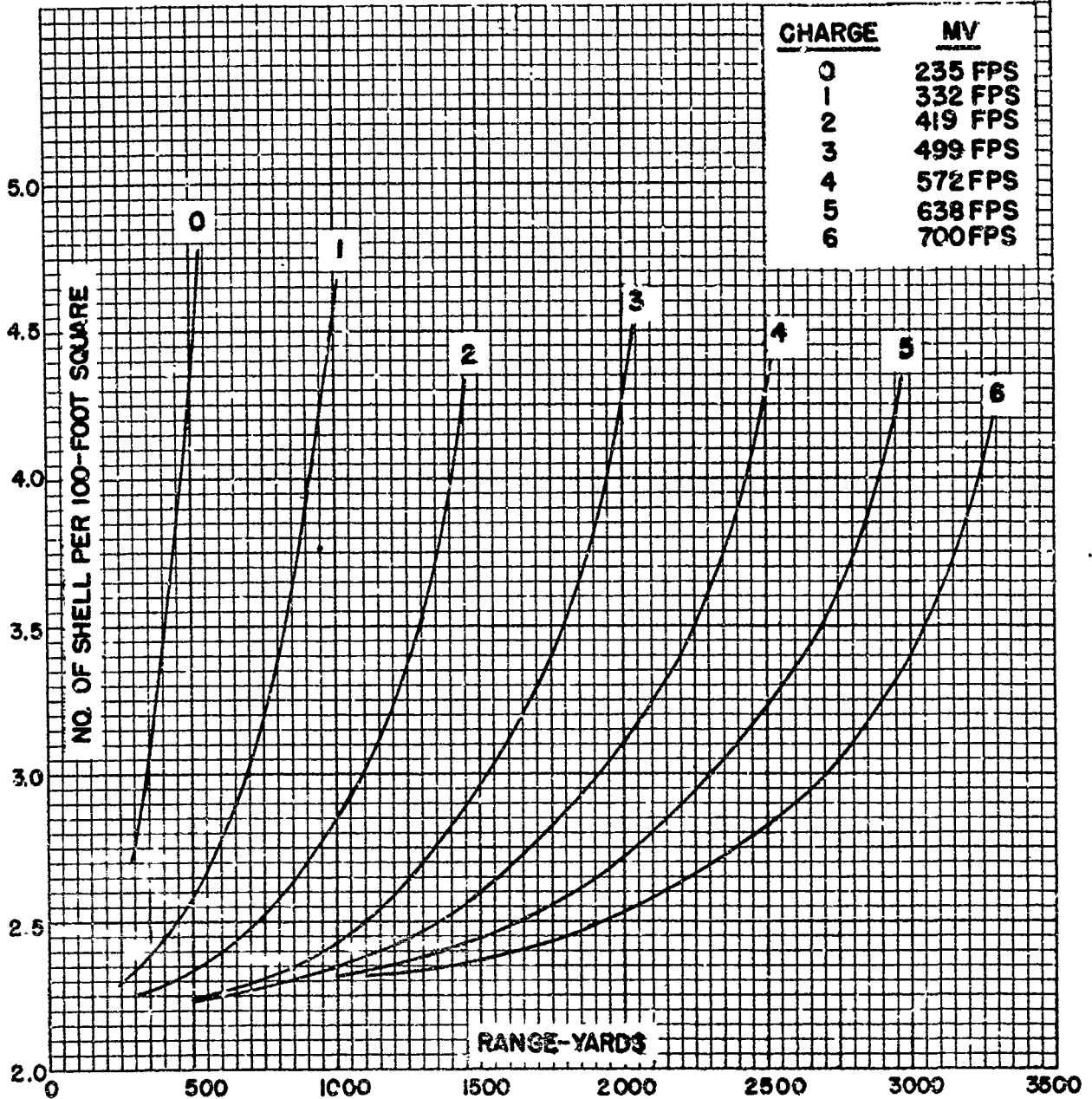

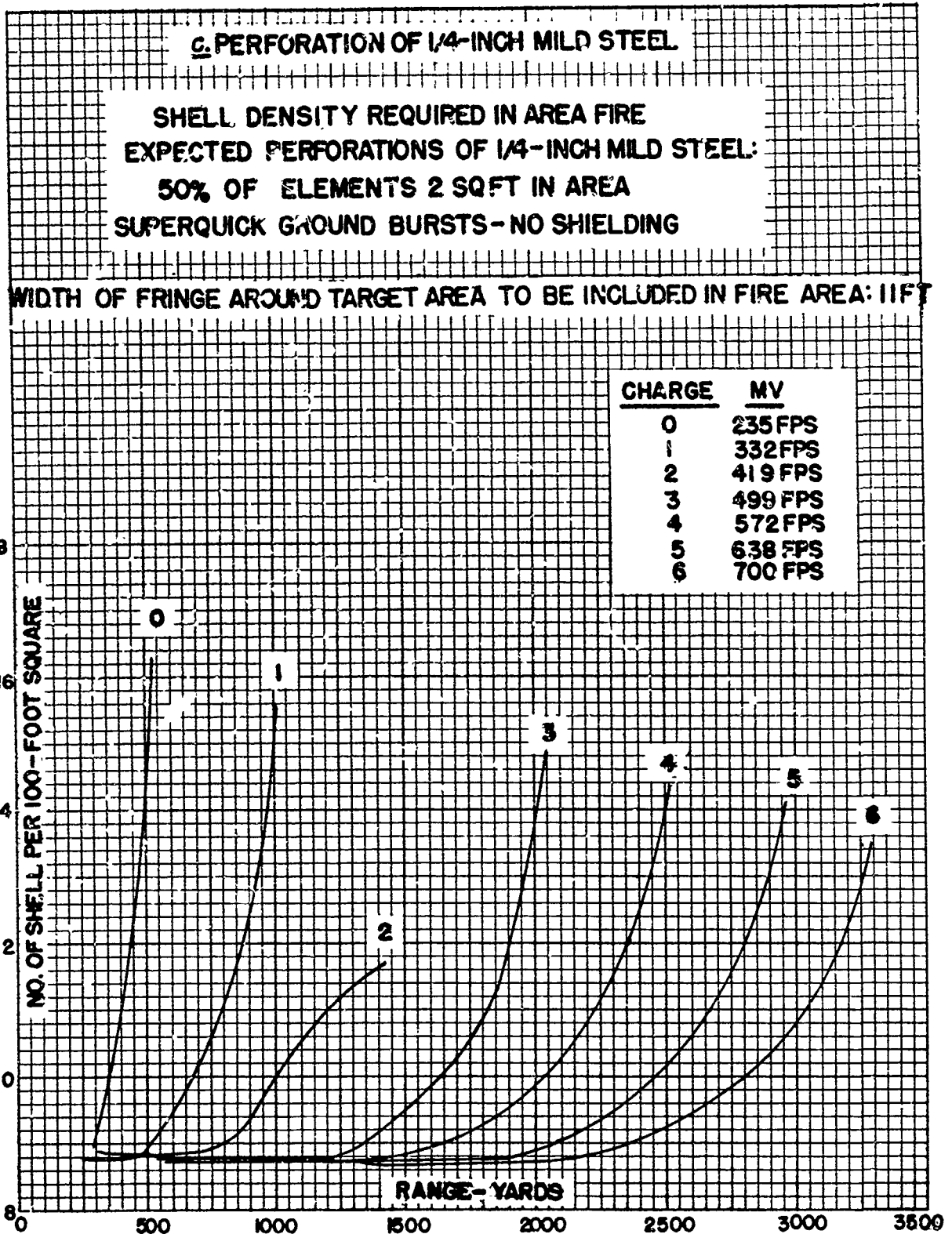

Ballistic Research Laboratories
Handbook of Ballistic and
Engineering Data for Ammunition,
No. 81-1-56

Ballistic Research Lab.
Aberdeen Proving Ground,
Maryland
4 February 1949

BALLISTIC AND ENGINEERING DATA

for

Shell, HE, 81-mm, M56

with

Fuze, PD, M53, M53A1 or M52A1, and Fuze, TSQ, M77

<u>Section</u>		<u>Paragraphs</u>
I	General -----	1
II	Description -----	2 - 4
III	Exterior ballistic data -----	5 - 7
IV	Effect data -----	8 - 9

SECTION I

GENERAL

	<u>Paragraph</u>
Purpose - - - - -	1

1. Purpose. The purpose of this number of the handbook is to furnish a concise collection of information regarding the shape, dynamics, ballistics and effects of the 81-mm High Explosive Shell M56 with the Point Detonating Fuze M53, M53A1 or M52A1, and with the Time and Superquick Fuze M77. This information is collected from the drawings, reports, firing tables, and technical manuals pertaining to this ammunition.

SECTION II

DESCRIPTION

	<u>Paragraph</u>
Drawings - - - - -	2
Dimensions - - - - -	3
Physical characteristics - - - - -	4

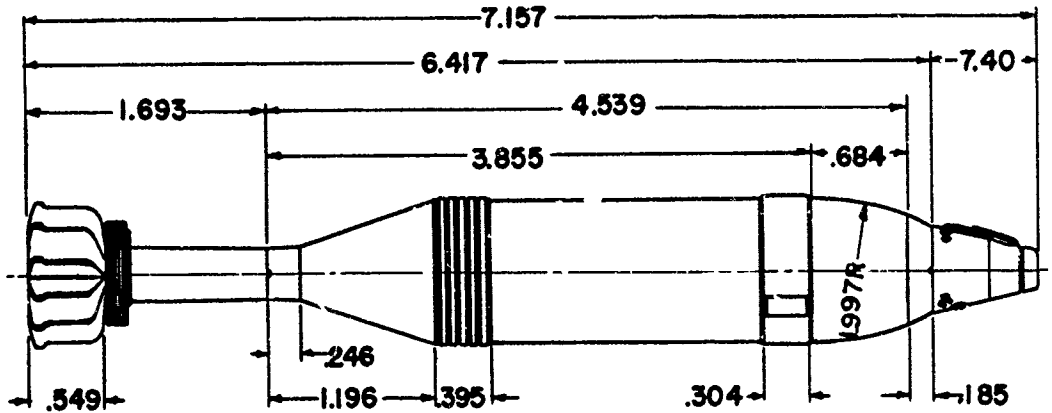

SHELL, HE, 81-MM, M56
FUZE, PD, M53

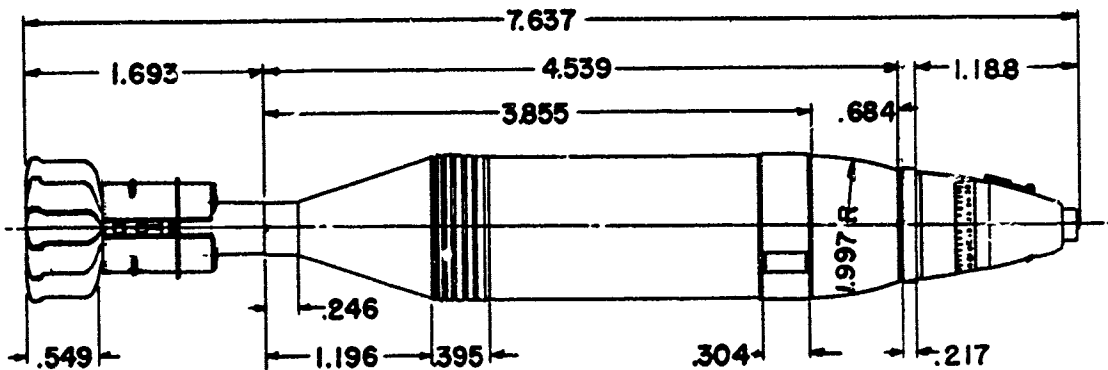

SHELL, HE, 81-MM, M56
FUZE, T SQ, M77

ALL DIMENSIONS IN CALIBERS
1 CALIBER = 3.189"

2. Drawings.

Shell: Metal parts assembly and details	75-2-283
Fins: Assembly and details	75-2-277
Increment, Propellant M2 or M2A1, and Holder: Assembly and details	71-12-16
Fuze M53 or M53A1: Assembly and details	73-1-165
Fuze M52A1: Assembly and details	73-1-161
Fuze M77: Assembly	73-3-171
Complete Round: Assembly and marking diagram, With Fuze M53	75-1-97
With Fuze M77	75-1-197
Ring for adapting shell to Fuze M77	73-3-175M

3. Dimensions.

Fins: Number	12
Length	0.549 cal
Length of assembly (outside)	1.693 cal
Shell: Length of rear part	1.196 cal
Length of rear bourrelet	0.395 cal
Length of front bourrelet	0.304 cal
Length of ogival part	0.684 cal
Radius of ogival arc	1.997 cal
Total length	4.539 cal
Adapter: Length (outside)	0.185 cal
Ring: Length	0.217 cal
Fuze: Length (outside) of M53	0.740 cal
M53A1	0.737 cal
M52A1	0.753 cal
M77	1.188 cal
Length: Shell, adapter, and fin assembly	6.417 cal
Same with Fuze M53	7.157 cal
Same with Fuze M77	7.637 cal

4. Physical characteristics.

With Fuze M53: Weight (standard)	10.62 lb
CG to juncture of adapter and fuze	2.324 cal*
With Fuze M77: Weight (standard)	11.62 lb

*The National Bureau of Standards located the center of gravity of a projectile filled with carbon tetrachloride, whose specific gravity is 1.61 at 22°C (Lyman J. Briggs, "Report on Aerodynamic characteristics of the 60-mm Mortar Projectile M49A2 and the 81-mm Mortar Projectile M56", N.B. of S. VI-4/64, 1942).

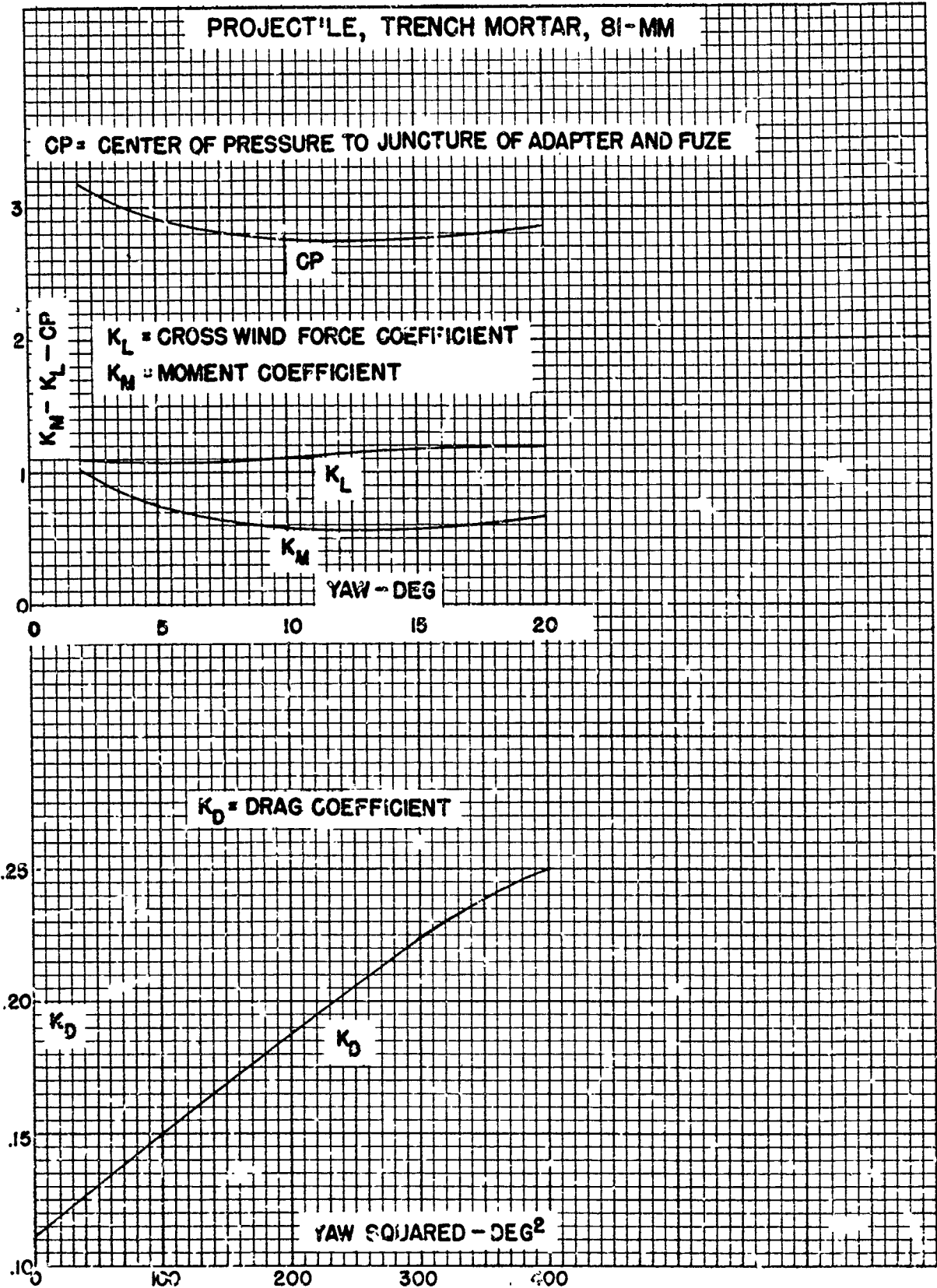

SECTION III
EXTERIOR BALLISTIC DATA

	Paragraph
Aerodynamic data - - - - -	5
Firing table data: PD Fuzes - - - - -	6
Firing table data: TSC Fuze - - - - -	7

5. Aerodynamic data. The aerodynamic coefficients shown graphically on page 4 were computed from the forces and torques measured by the Bureau of Standards in a wind tunnel at a velocity of 100 fps (see par. 4).

6. Firing table data: PD Fuzes.

FT 81-C-2. (Part I).

Mortars, 81-mm, M1 and M21; Smooth bore: Muzzle loading. Projectile weight: 10.62 lb. OCM items 15627 and 15674 recommended and approved standardization of the HE Shell M56 with PD Fuze M53 for the 81-mm Mortar M1. OCM items 28162 and 28822 recommended and approved standardization of this ammunition for the 81-mm Mortar M21; OCM item 31408 restandardized it after further development of the mortar. FT 81-Q-2 (abridged) is a range-elevation table for the 81-mm Mortar T27, which is the M21 Mortar without the Extension Tube and is used with charges 1 and 2 at short ranges. OCM items 24288 and 24598 recommended and approved the classification of the PD Fuze M52A1 as substitute standard for the HE Shell M56.

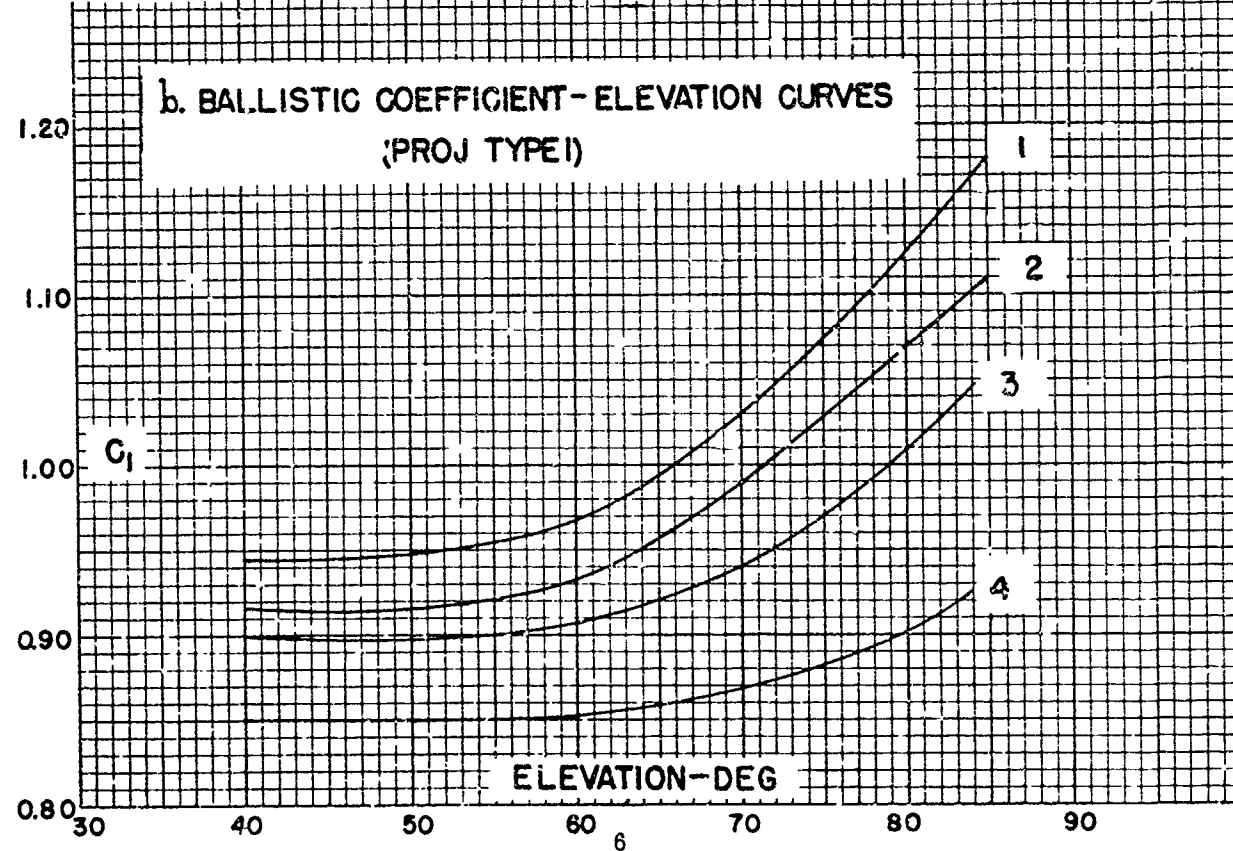
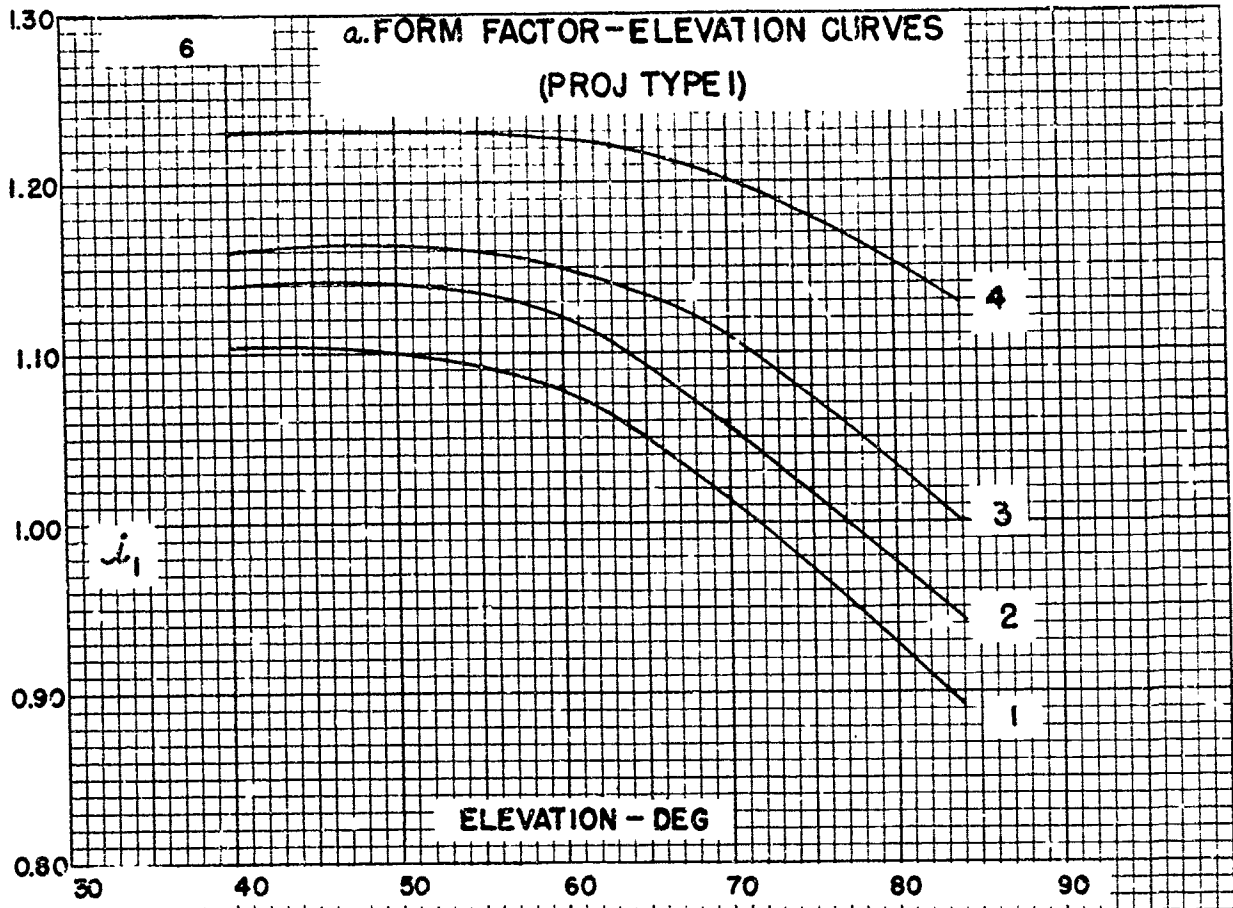

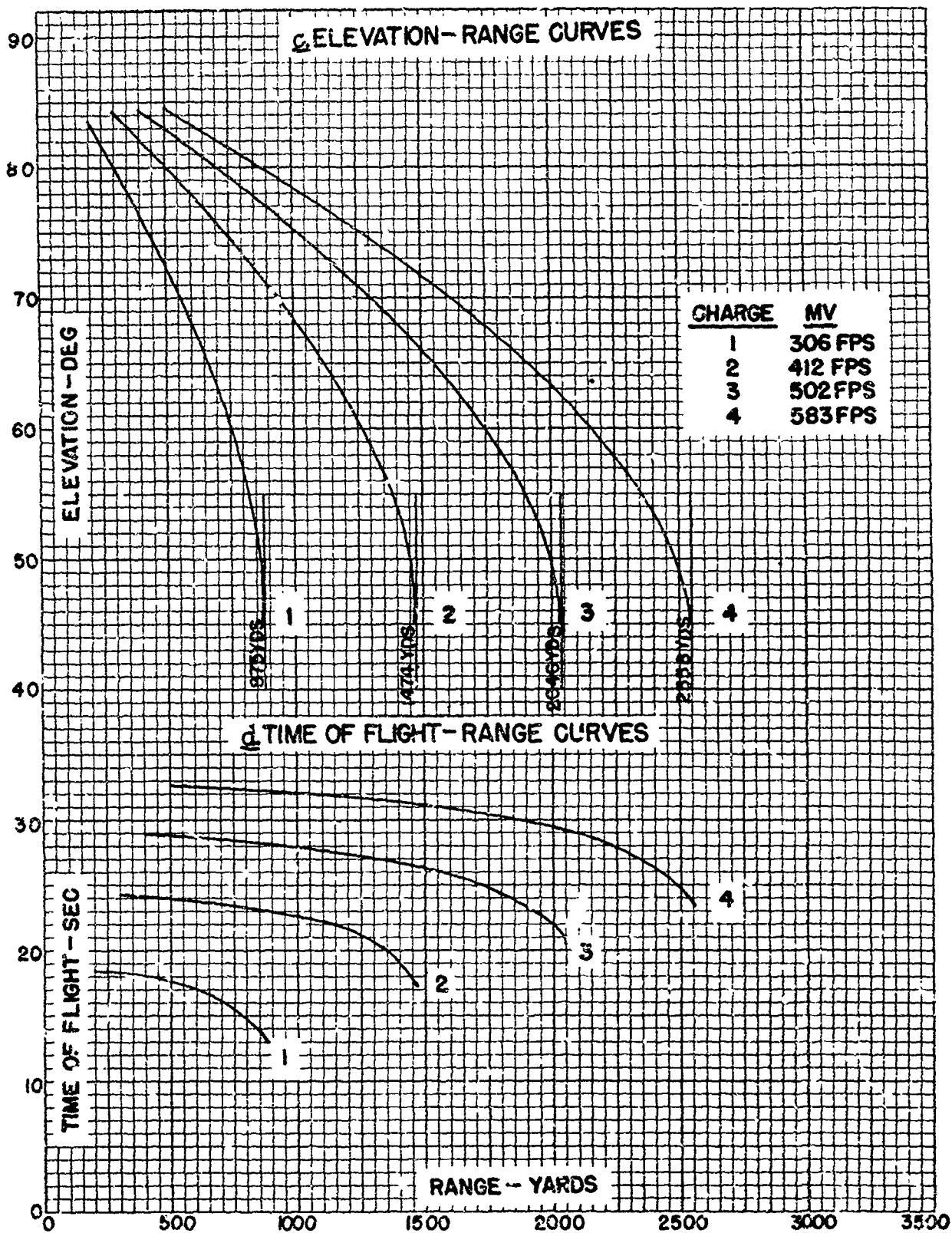

7. FIRING TABLE DATA: T. SQ. FUZE. FT 81-S-1 (ABRIDGED)
MORTARS, 81-MM, M1 AND M21

OCM ITEMS 24288 AND 24598 RECOMMENDED AND APPROVED STANDARDIZATION
OF FUZE, T. SQ, M77 FOR SHELL, HE, 81-MM, M56. PROJ WEIGHT 11.62 LB

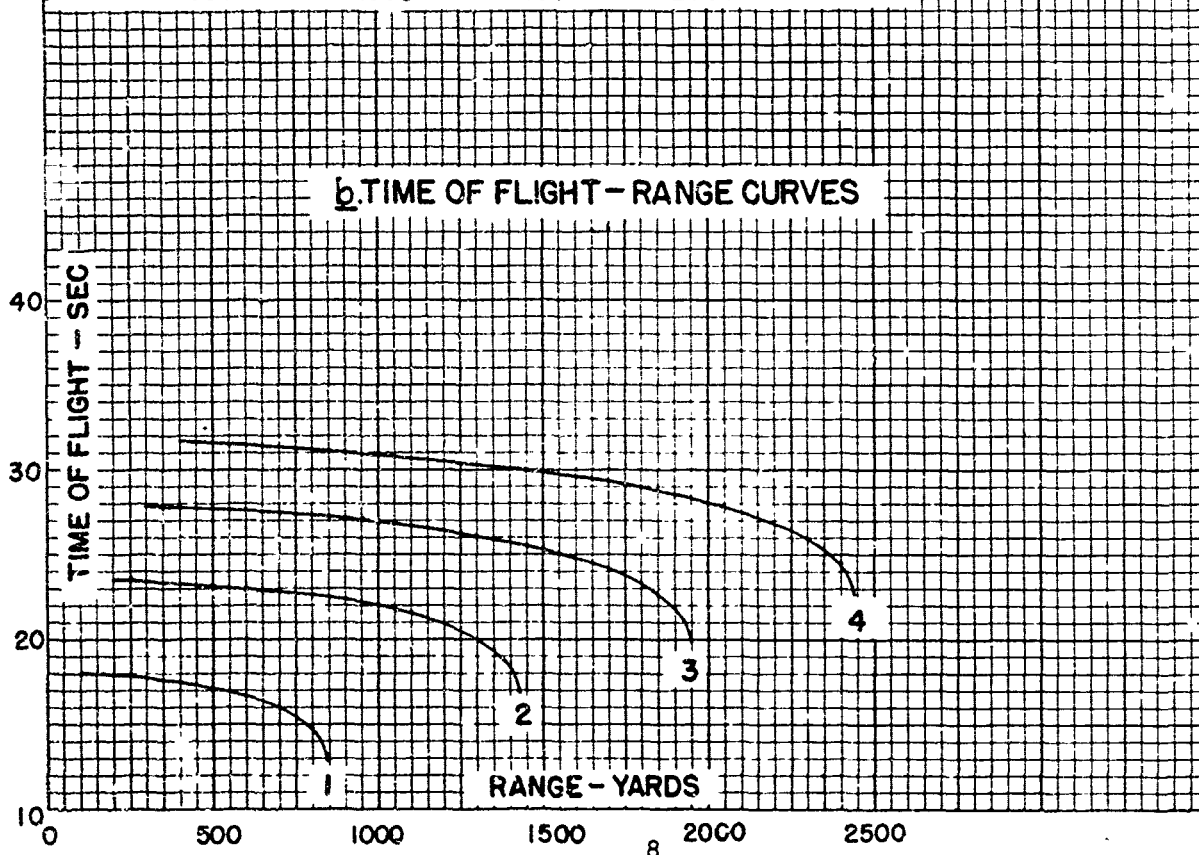
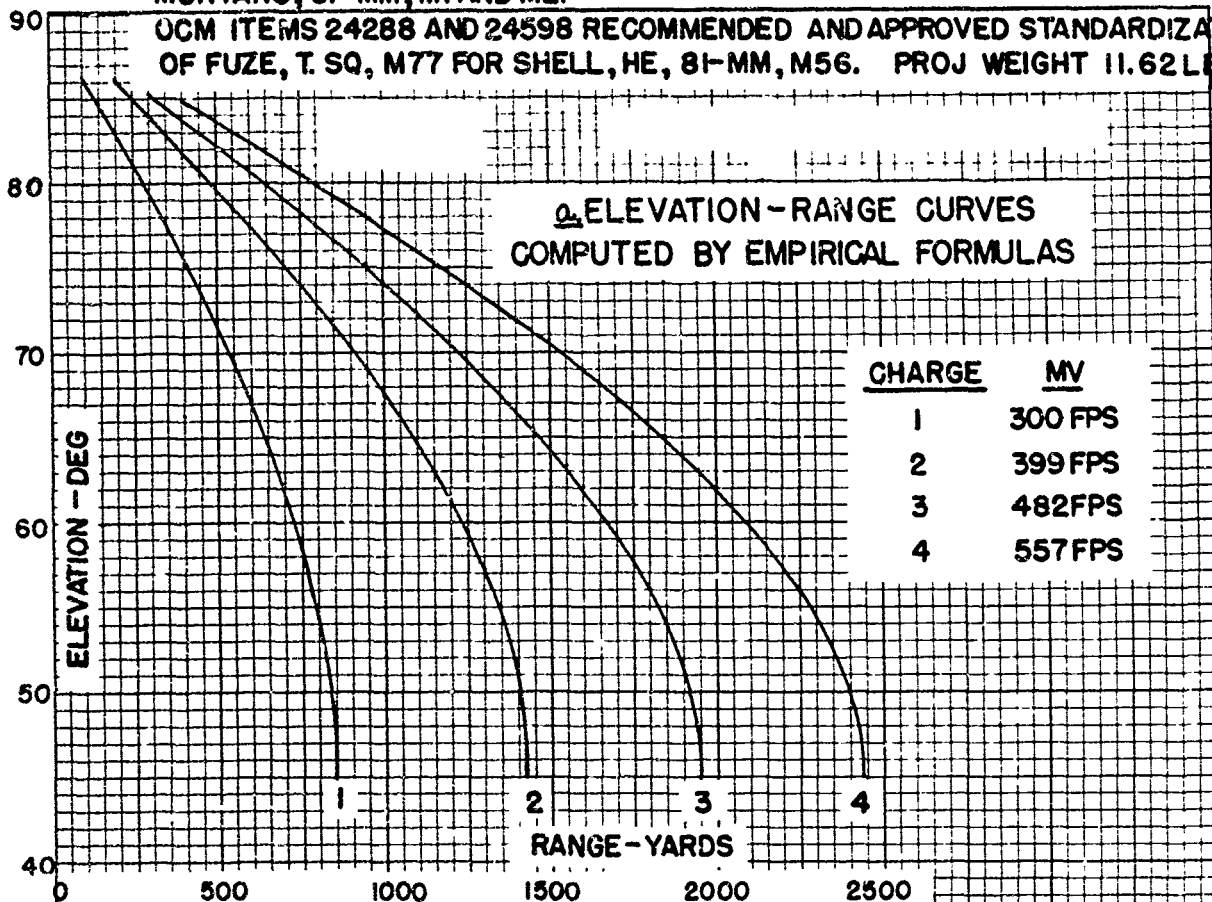

SECTION IV
EFFECT DATA

	<u>Paragraph</u>
Fragmentation - - - - -	8
Penetration - - - - -	9

8. **Fragmentation.** The data on fragmentation of the 81-mm HE Shell M56 were taken from TM9-1907, "Ballistic Data, Performance of Ammunition" (Sep 1944) and Vol. III of "Terminal Ballistic Data" (Sep 1945). The initial fragment velocity is 6,180 fps.

a. **Casualties.**TABLE 44
CASUALTIES

Distance from burst (ft)	Total number of effective fragments	Average number of effective frag- ments per sq ft	For the lightest effective fragment	
			Weight (oz)	Velocity (fps)
r	N	B	m	v
20	2580	0.513	0.004	3860
30	2060	0.182	0.006	3150
40	1680	0.0836	0.008	2720
60	906	0.0200	0.014	2060
80	614	0.0076	0.021	1680
100	412	0.0033	0.029	1430
150	170	0.0006	0.056	1030
200	112	0.0002	0.080	862
300	63	0.0001	0.128	682

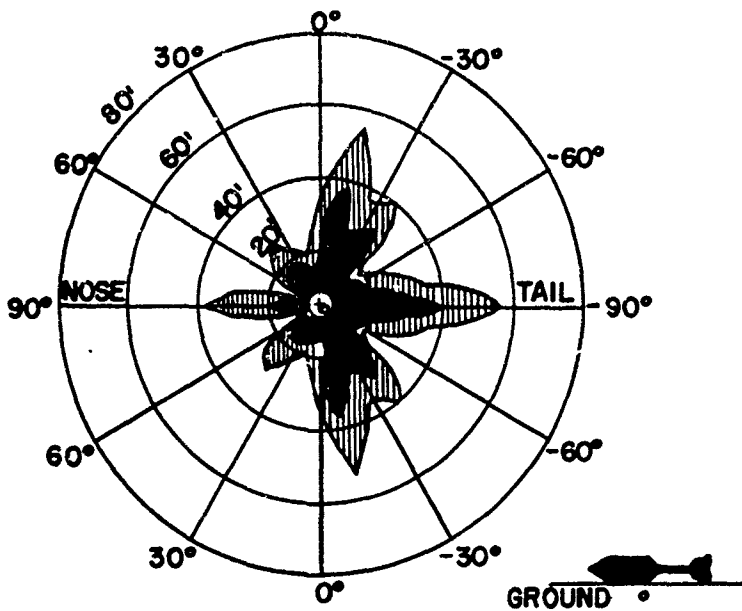

CASUALTIES

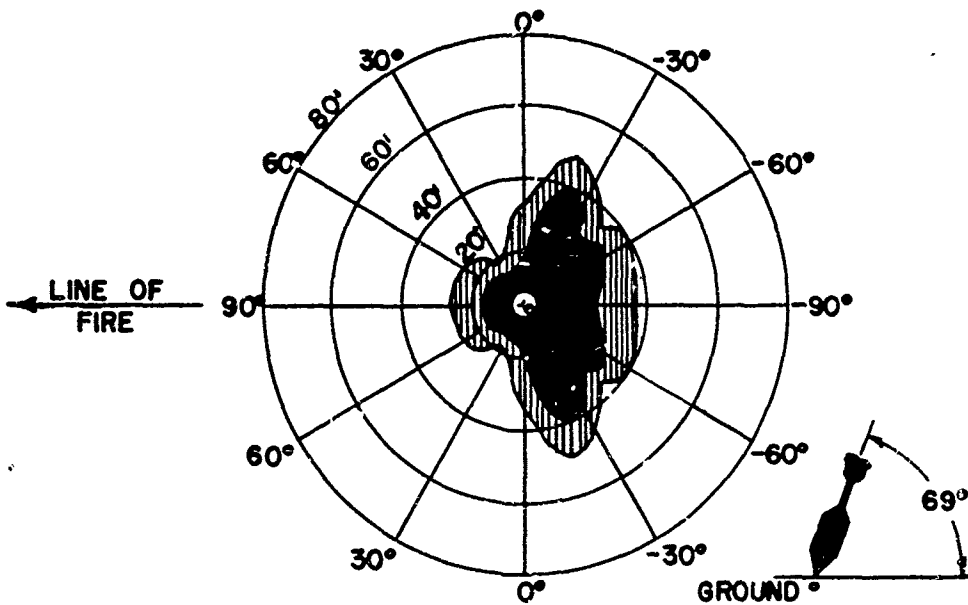

**INCLINATION 0°
HEIGHT OF BURST 0 FT
REMAINING VELOCITY 0 FPS**



**INCLINATION 69°
HEIGHT OF BURST 0 FT
REMAINING VELOCITY 459 FPS**

-  AT LEAST 1 HIT PER 4 SQ. FT.
-  AT LEAST 1 HIT PER 10 SQ. FT.

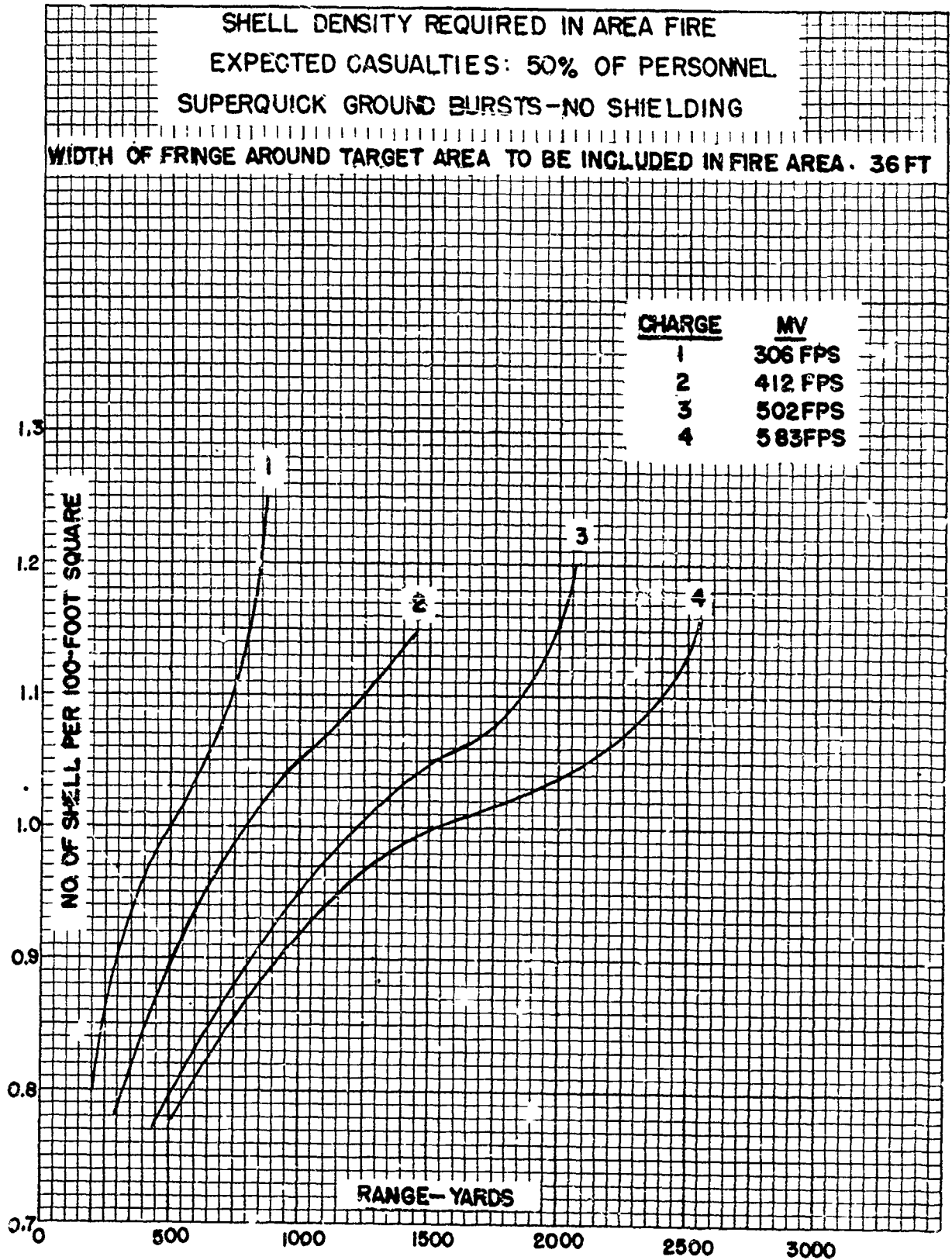

b. Perforation of 1/8-inch mild steel.

TABLE 45
PERFORATION OF 1/8 IN. MILD STEEL

Distance from burst (ft)	Total number of effective fragments	Average number of effective frag- ments per sq ft	For the lightest effective fragment	
			Weight (oz)	Velocity (fps)
r	N	B	m	v
20	1040	0.208	0.012	4060
30	762	0.0674	0.017	3580
40	583	0.0290	0.022	3200
60	314	0.0069	0.035	2700
80	193	0.0024	0.051	2360
100	130	0.0010	0.071	2110
120	76	0.0004	0.097	1900
140	63	0.0003	0.128	1780
170	40	0.0001	0.188	1560

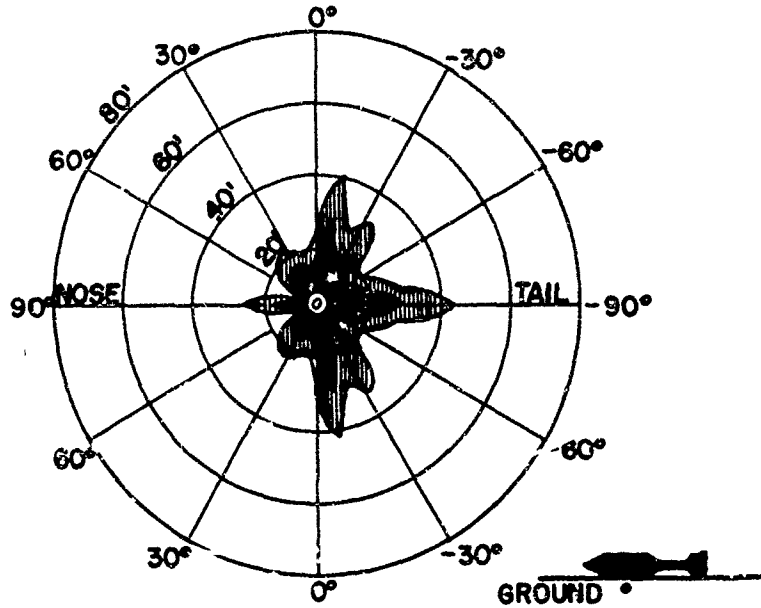

PERFORATION OF 1/8-INCH MILD STEEL

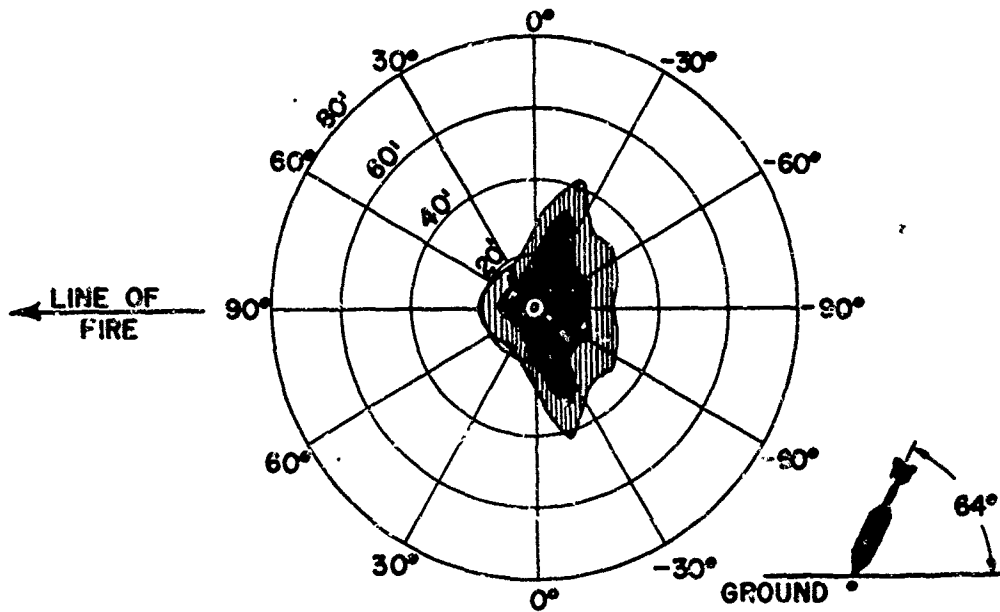

INCLINATION 0°
HEIGHT OF BURST 0 FT
REMAINING VELOCITY 0 FPS



INCLINATION 64°
HEIGHT OF BURST 0 FT
REMAINING VELOCITY 459 FPS

-  AT LEAST 1 HIT PER 4 SQ FT
-  AT LEAST 1 HIT PER 10 SQ FT

**SHELL DENSITY REQUIRED IN AREA FIRE
EXPECTED PERFORATIONS OF 1/8-INCH MILD STEEL:
50% OF ELEMENTS 2 SQ FT IN AREA
SUPERQUICK GROUND BURSTS - NO SHIELDING**

WIDTH OF FRINGE AROUND TARGET AREA TO BE INCLUDED IN FIRE AREA: 22 FT

<u>CHARGE</u>	<u>MV</u>
1	306 FPS
2	412 FPS
3	502 FPS
4	583 FPS

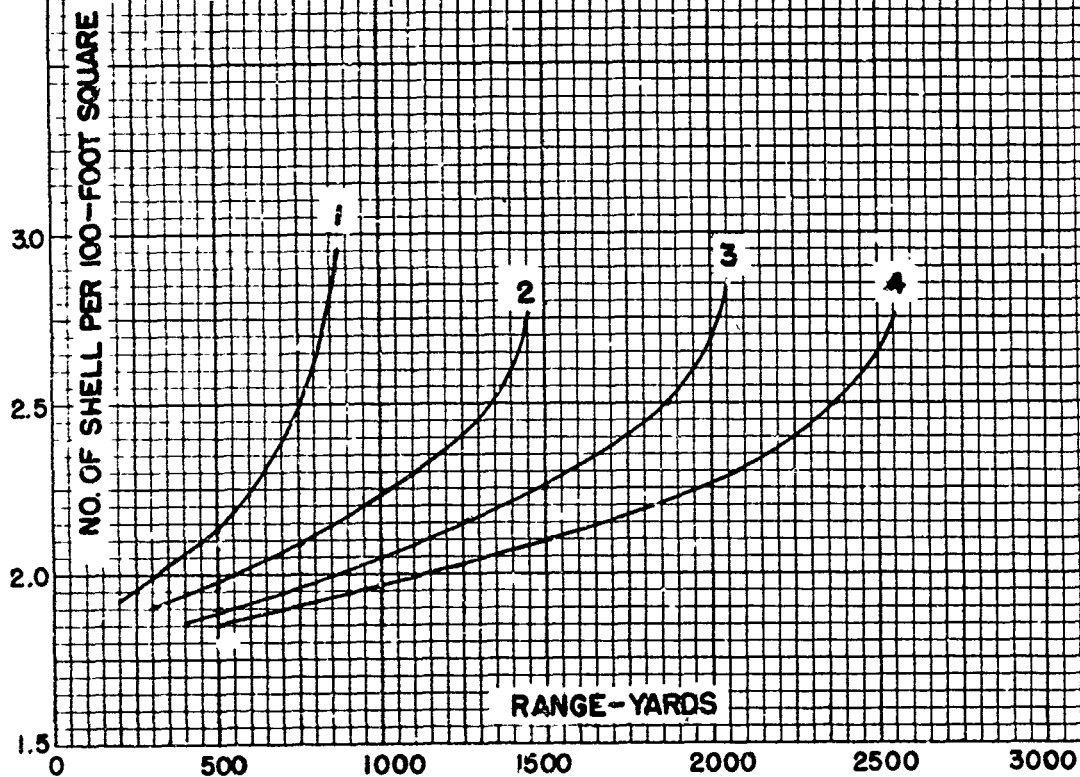

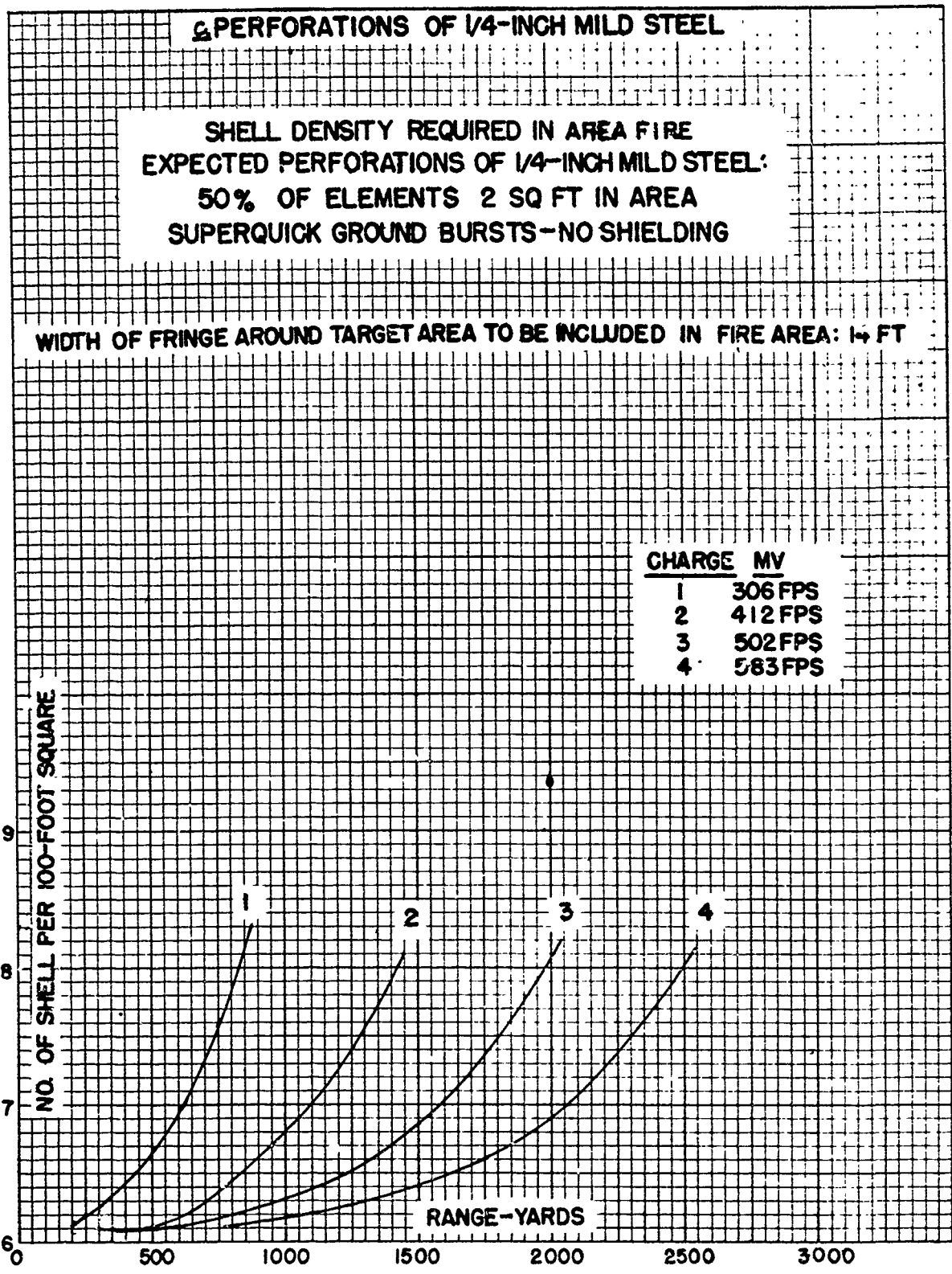

9. PENETRATION

FROM VOL. III, "TERMINAL BALLISTIC DATA"

**PENETRATION INTO MEDIUM EARTH AND LOGS
PD FUZE**

**HORIZONTAL LOG ROOFS.
ADD PENETRATION INTO EARTH COVERING (IF ANY) TO
PENETRATION INTO WOOD (USING APPROPRIATE SCALES)**

CHARGE	MV
1	306 FPS
2	412 FPS
3	502 FPS
4	583 FPS

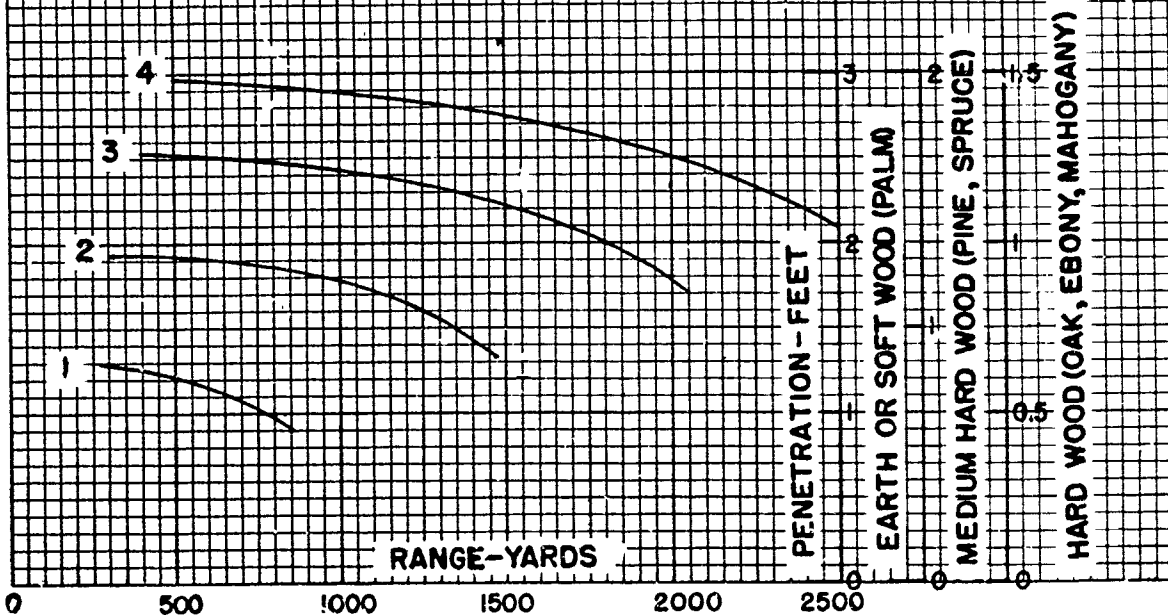

Ballistic Research Laboratories
Handbook of Ballistic and
Engineering Data for Ammunition,
No. 81-1-57

Ballistic Research Lab.
Aberdeen Proving Ground,
Maryland
8 February 1949

BALLISTIC AND ENGINEERING DATA

for

Shell, Smoke, 81-mm, M57

with

Fuze, PD, M52 or M52A1, and Fuze, TSQ, M77

<u>Section</u>	<u>Paragraphs</u>
I General -----	1
II Description -----	2 - 4
III Exterior ballistic data -----	5 - 8

**SECTION I
GENERAL**

	<u>Paragraph</u>
Purpose -----	1

1. **Purpose.** The purpose of this number of the handbook is to furnish a concise collection of information regarding the shape, dynamics and ballistics of the 81-mm Smoke Shell M57 with the Point Detonating Fuze M52 or M52A1 and with the Time and Superquick Fuze M77. This information is collected from the drawings, reports, and firing tables pertaining to this ammunition.

**SECTION II
DESCRIPTION**

	<u>Paragraph</u>
Drawings -----	2
Dimensions -----	3
Physical characteristics -----	4

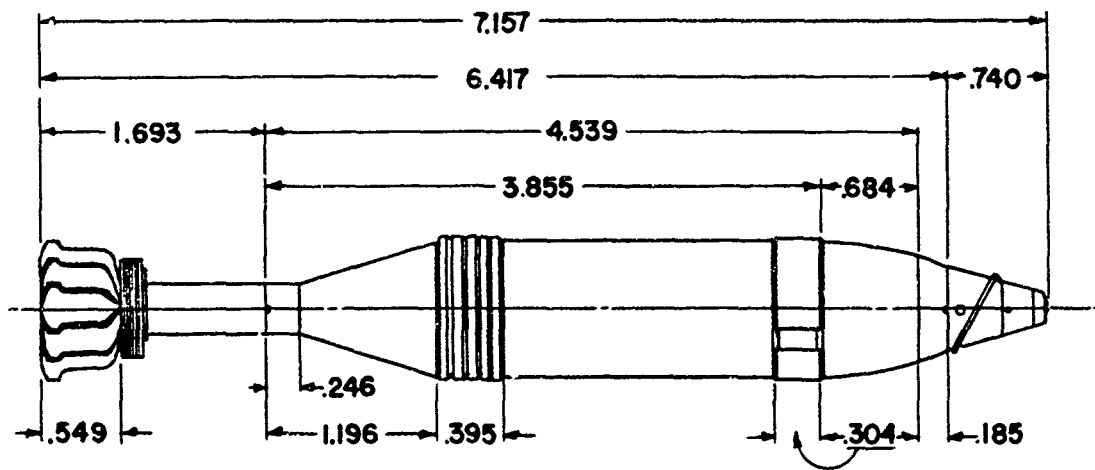

SHELL, SMOKE, 81-MM, M57
FUZE, PD, M52

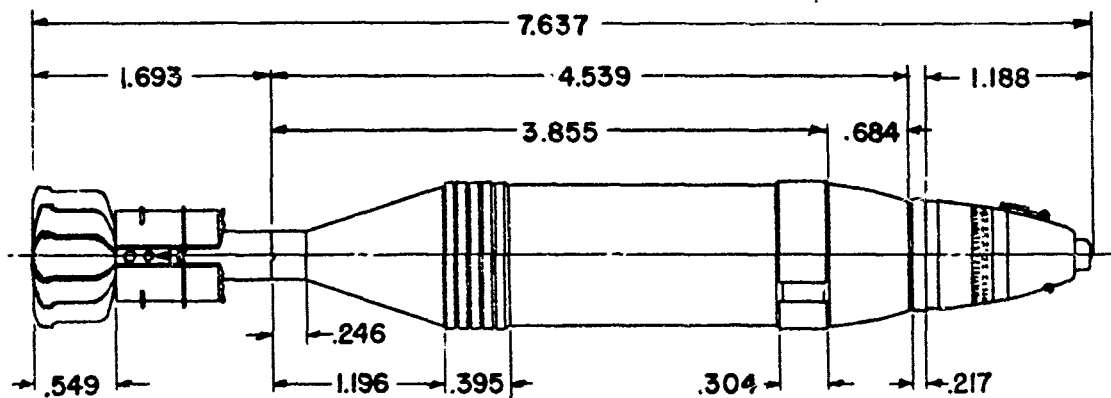

SHELL, SMOKE, 81-MM, M57
FUZE, T SQ., M77

ALL DIMENSIONS IN CALIBERS
1 CALIBER = 3.189"

2. Drawings.

Shell: Metal parts assembly and details	75-2-284
Fins: Assembly and details	75-2-277
Increment, Propellant, M2 or M2A1, and Holder:	
Assembly and details	71-12-16
Fuze: Assembly and details	73-1-161
Complete Rounds: Assembly and marking diagram,	
With Fuze M52 and FS	75-1-94
With Fuze M52 and WP	75-1-93
With Fuze M77 and FS	75-1-198
With Fuze M77 and WP	75-1-199
Ring for adapting shell to Fuze M77	73-3-175M

3. Dimensions.

Fins: Number	12
Length	0.549 cal
Length of assembly (outside)	1.693 cal
Shell: Length of rear part	1.196 cal
Length of rear bourrelet	0.395 cal
Length of front bourrelet	0.304 cal
Length of ogival part	0.684 cal
Radius of ogival arc	1.997 cal
Total length	4.539 cal
Adapter: Length (outside)	0.185 cal
Ring: Length	0.217 cal
Fuze: Length (outside) of M52	0.740 cal
M52A1	0.753 cal
M77	1.188 cal
Length: Shell, adapter, and fin assembly	6.417 cal
Same with Fuze M52	7.157 cal
Same with Fuze M77	7.637 cal

4. Physical characteristics.**a. Chemical charges.**

(1) Fuming Spray: A liquid, which turns to smoke when released.

(2) White Phosphorus: A pale yellow solid. A layer of 1/8 inch of water is included in the charge.

When released, this forms a white smoke, which is poisonous.

b. Weights. The standard weights of the fuzed projectiles are:

<u>Charge</u>	<u>Fuze M52</u>	<u>Fuze M77</u>
FS	11.86 lb	13.03 lb
WP	11.36 lb	12.53 lb

SECTION III
EXTERIOR BALLISTIC DATA

	<u>Paragraph</u>
Aerodynamic data - - - - -	5
Firing table data (FS) : PD Fuze - - - - -	6
Firing table data (WP): PD Fuze - - - - -	7
Firing table data (WP): TSQ Fuze - - - - -	8

5. Aerodynamic data. Since the Smoke Shell M57 has the same shape as the High Explosive Shell M56, its drag coefficient and cross wind force coefficient should be the same. These are given in OH 81-1-56. The position of the center of gravity and consequently the moment coefficient may be different with the chemical charges from what they are with the high explosive charge; they have not been measured with the chemical charges.

6. Firing table data (FS): PD Fuze.

FT 81-C-2 (Part 2)

Mortars, 81-mm, M1 and M21. Smooth bore; muzzle loading. Projectile weight: 11.86 lb. OCM items 15627 and 15674 recommended and approved standardization of the Smoke Shell M57 with PD Fuze M52 for the 81-mm Mortar M1. OCM items 28162 and 28822 recommended and approved standardization of this ammunition for the 81-mm Mortar M21; OCM item 31408 restandardized it after further development of the mortar. FT 81-Q-2 (abridged) has a range-elevation table for the 81-mm Mortar T27, which is the M21 Mortar without the Extension Tube and is used with charges 1 and 2 at short ranges.

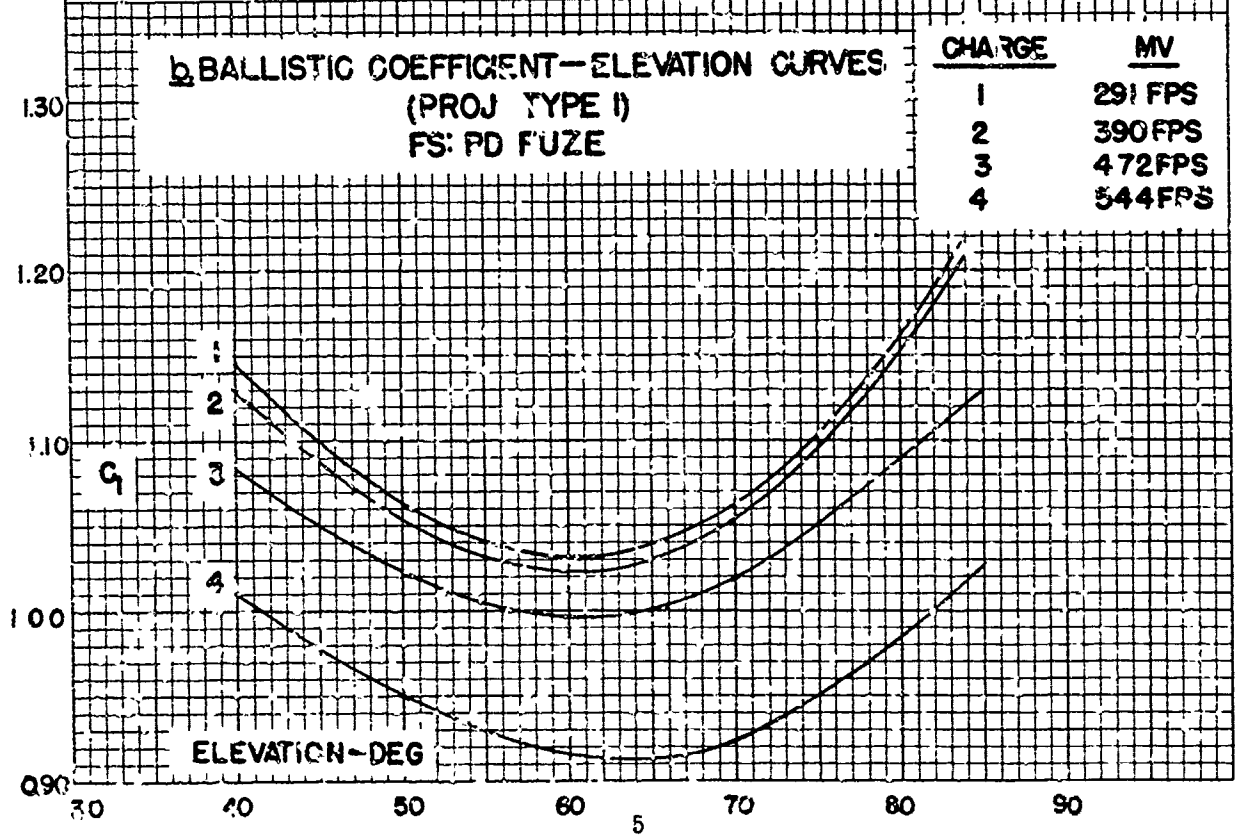
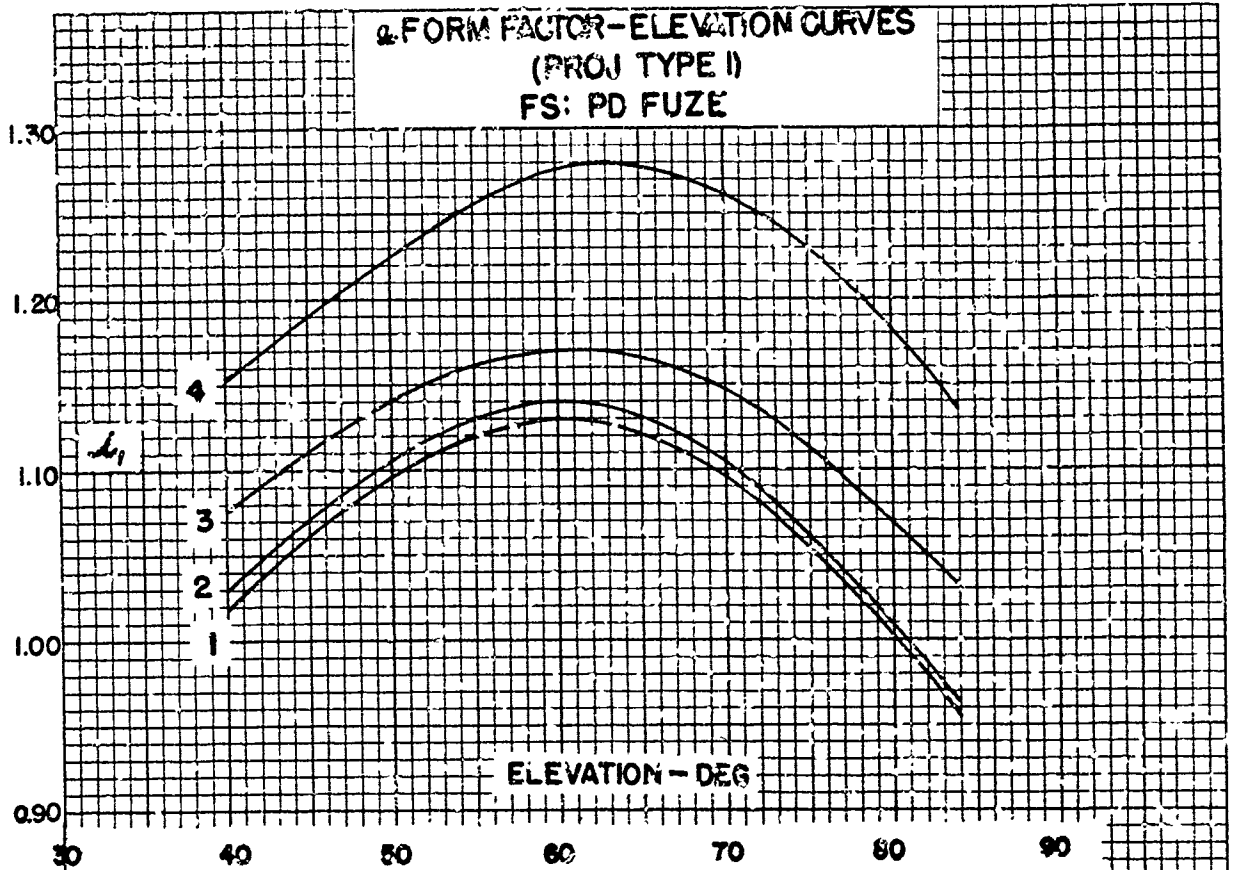

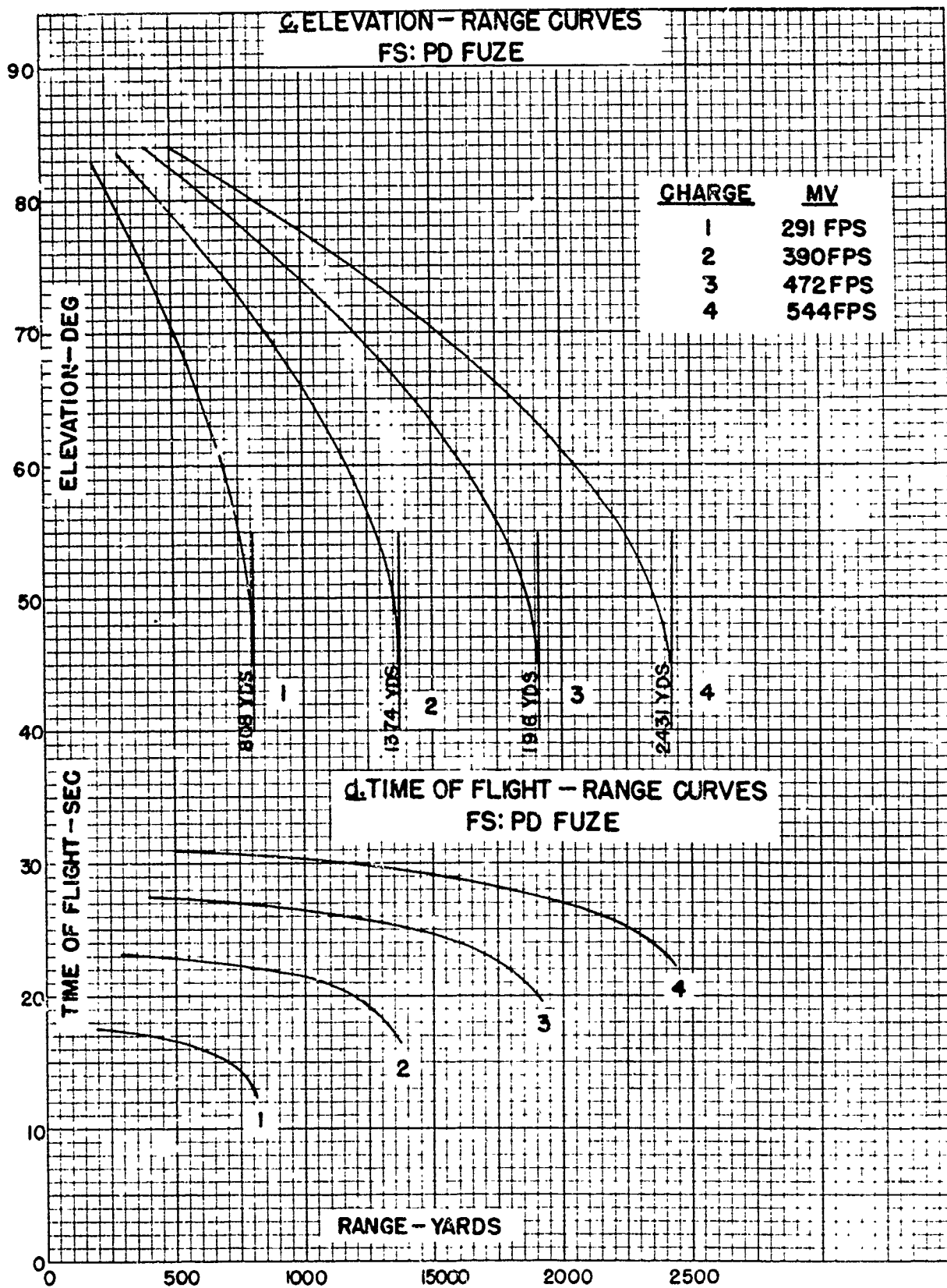

7. FIRING TABLE DATA (WP): PDPFUZE
 FT 81-C-2 (PART III)
 PROJECTILE WEIGHT: 11.36 LB.
 (FOR MORTARS AND OCM ITEMS, SEE PAR. 6)

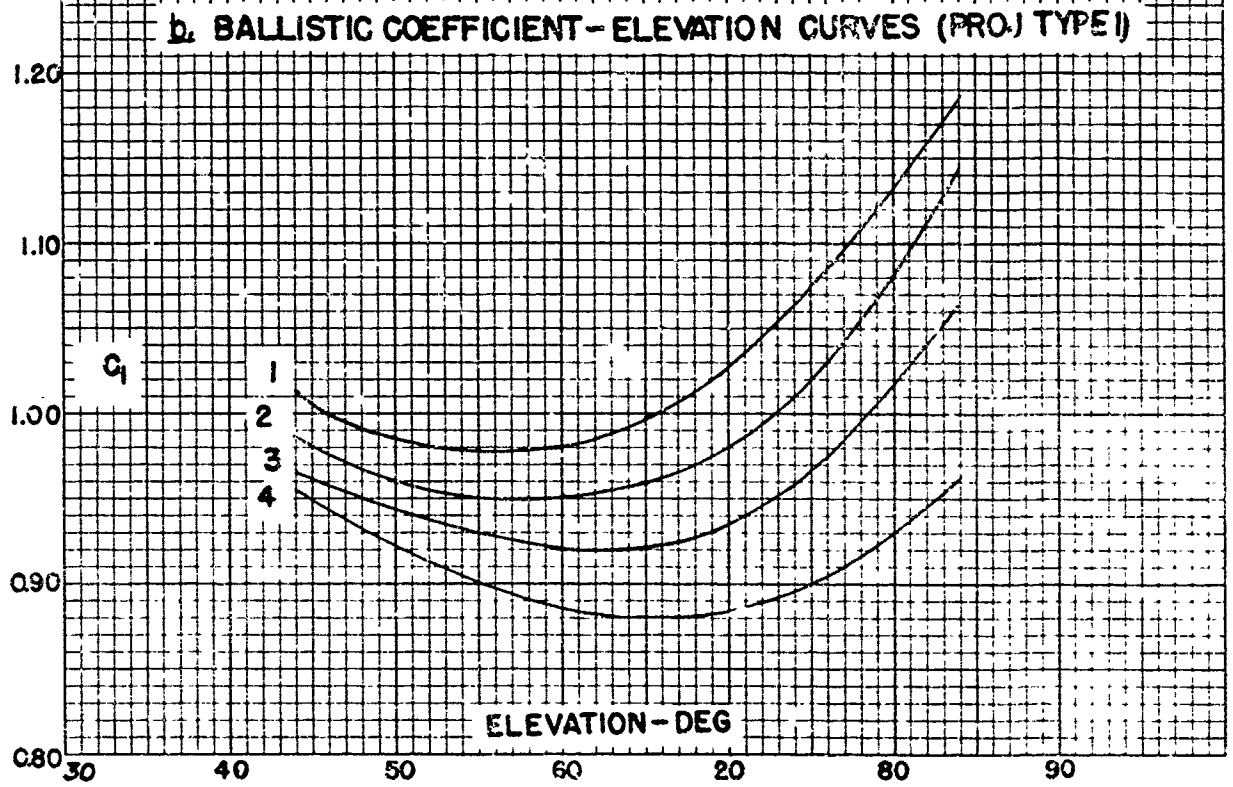
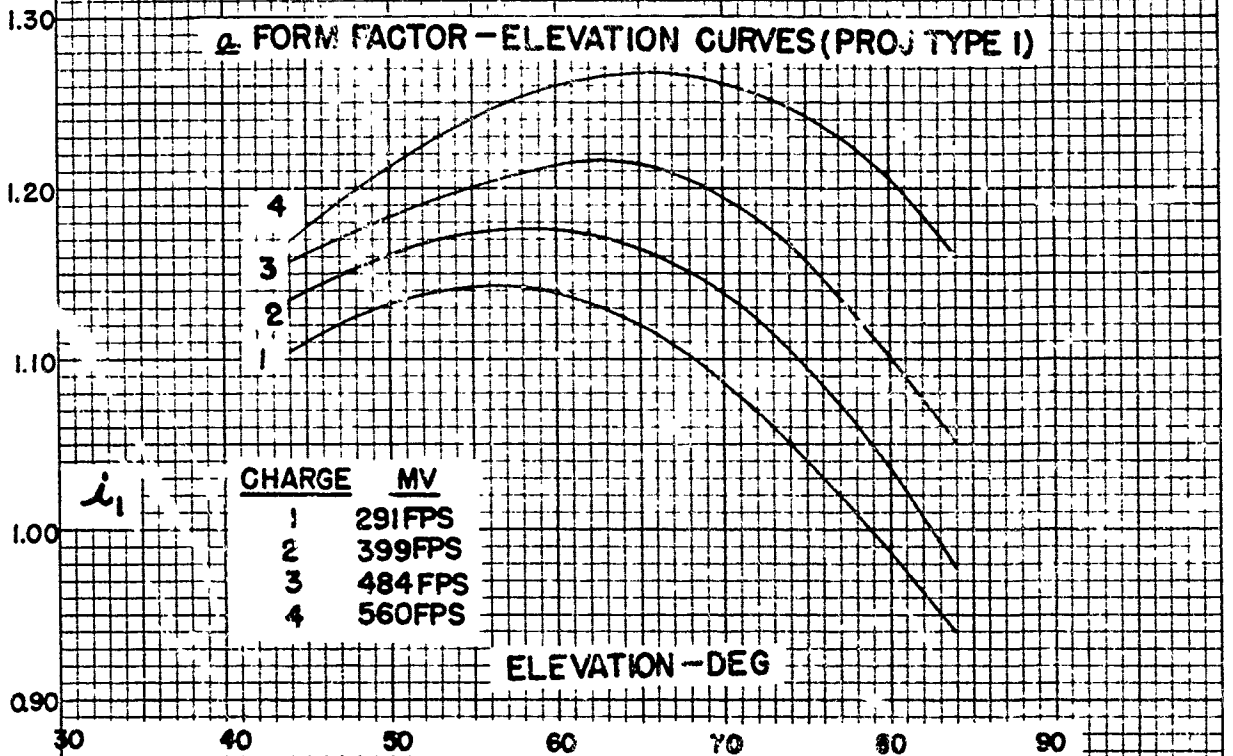

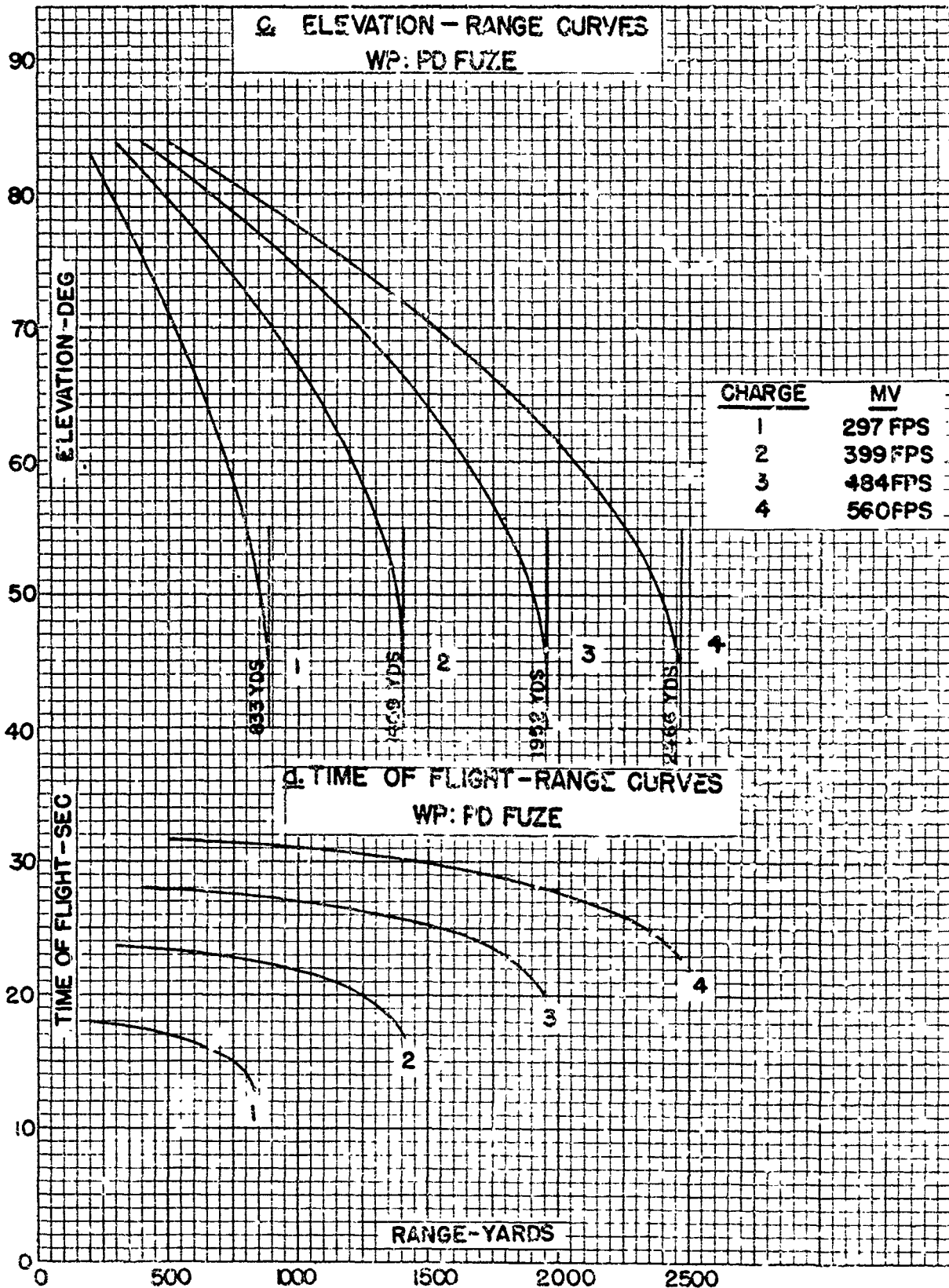

B. FIRING TABLE DATA (WP): T.SQ.FUZE

FT 81-S-1 (ABRIDGED) PROJ WEIGHT 12.45 LB
 MORTARS, 81-MM, M1 AND M21
 OCM ITEMS 24288 AND 24598 RECOMMENDED AND APPROVED STANDARDIZATION
 OF FUZE, T.SQ.M77 FOR SHELL, SMOKE, 81-MM, M57.

ELEVATION - RANGE CURVES
 COMPUTED BY EMPIRICAL FORMULAS

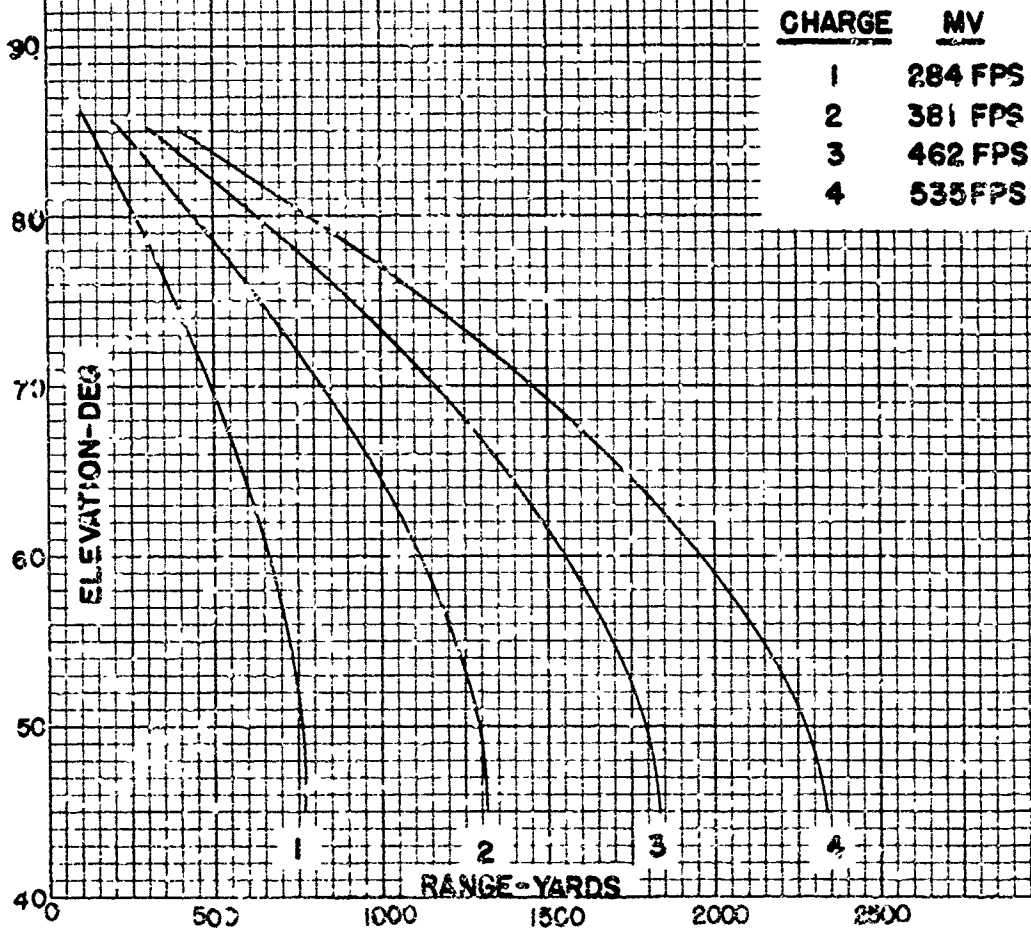

Ballistic Research Laboratories
Handbook of Ballistic and
Engineering Data for Ammunition,
No. 90-1-T33

Ballistic Research Lab.
Aberdeen Proving Ground,
Maryland.
11 February 1949

BALLISTIC AND ENGINEERING DATA

for
Shot, AP, 90-mm, T33
with
Tracer

<u>Section</u>		<u>Paragraphs</u>
I	General -----	1
II	Description -----	2 - 4
III	Interior ballistic data -----	5
IV	Exterior ballistic data -----	6 - 7
V	Effect data -----	8

SECTION I
GENERAL

	<u>Paragraph</u>
Purpose - - - - -	1

1. Purpose. The purpose of this number of the handbook is to furnish a concise collection of information regarding the shape, dynamics, ballistics, and effects of the 90-mm Armor-piercing Shot T33 with Tracer. This information is collected from the drawings, reports, firing tables, and technical manuals pertaining to this ammunition.

ALL DIMENSIONS IN CALIBERS

1 CAL. = 3.543"

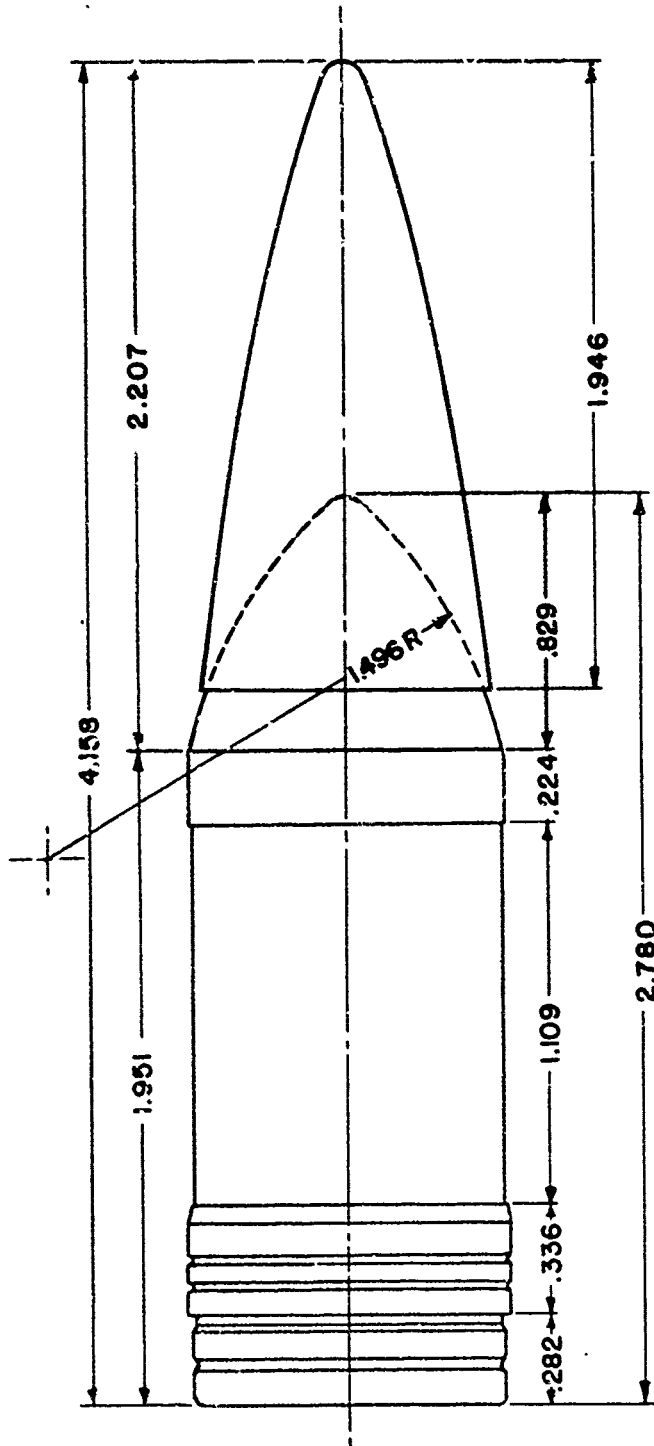

SHOT, AP, 90-MM, T33

**SECTION II
DESCRIPTION**

	<u>Paragraph</u>
Drawings - - - - -	2
Dimensions - - - - -	3
Physical characteristics - - - - -	4

2. Drawings.

Shot: Metal parts assembly and details	75-2-388
Body	75-18-44A
Windshield	75-18-51A

3. Dimensions.

Band: Distance from base	0.282 cal
Width	0.336 cal
Body: Cylindrical length	1.951 cal
Ogival length	0.829 cal
Radius of ogival arc	1.496 cal
Windshield: Length	1.946 cal
Radius of ogival arc	9.015 cal
Length: Ogive	2.207 cal
Shot	4.158 cal

4. Physical characteristics.

Weight (standard)	24.06 lb
Base to center of gravity	1.241 cal
Axial moment of inertia	35.64 lb.in ²
Transverse moment of inertia	191.4 lb.in ²

**SECTION III
INTERIOR BALLISTIC DATA**

	<u>Paragraph</u>
Theoretical yaw in bore - - - - -	5

5. Theoretical yaw in bore.

Minimum	3.0 min
Maximum	5.5 min

SECTION IV
EXTERIOR BALLISTIC DATA

	<u>Paragraph</u>
Aerodynamic data - - - - -	6
Firing table data - - - - -	7

6. Aerodynamic data.

a. Drag. The following data were obtained by resistance firings (see Ballistic Research Laboratory Memorandum Reports 336, "Ballistics of 90-mm AP Shot T33", and 347D, "Stability Factor of 90-mm Shot T30E15, and Form Factors of 90-mm Shot T30E15, APC Projectile M82, and AP Shot T33").

<u>Velocity</u> fps	<u>Drag</u> <u>Function</u>	<u>Form</u> <u>Factor</u>	<u>Ballistic</u> <u>Coefficient</u>	<u>Drag</u> <u>Coefficient</u>
2666	G ₆	1.01	1.90	.121
3029	G ₇	1.81	1.81	.108

b. Stability. Ballistic Research Laboratory Memorandum Report 336, "Ballistics of 90-mm AP Shot T33", gives the results obtained from stability firings of this projectile from the 90-mm Gun M1

Muzzle velocity	2700 fps
Moment coefficient	1.24
Twist of rifling	1/32
Stability factor	2.12

7. Firing table data. FT 90-F-1

Guns, 90-mm, M1, M1A1, M2, M3 and M26.
Twist of rifling: 1/32.
Muzzle velocity: 2800 fps.
Projectile Weight: 24.0 lb.

OCM item 29599 recommended that the AP Shot T33 be classified as limited standard; by item 30181, it was made limited procurement type.

- a. Form factor** (Proj Type 7). $i_7 = 0.97$.
- b. Ballistic coefficient** (Proj Type 7): $C_7 = 1.98$.

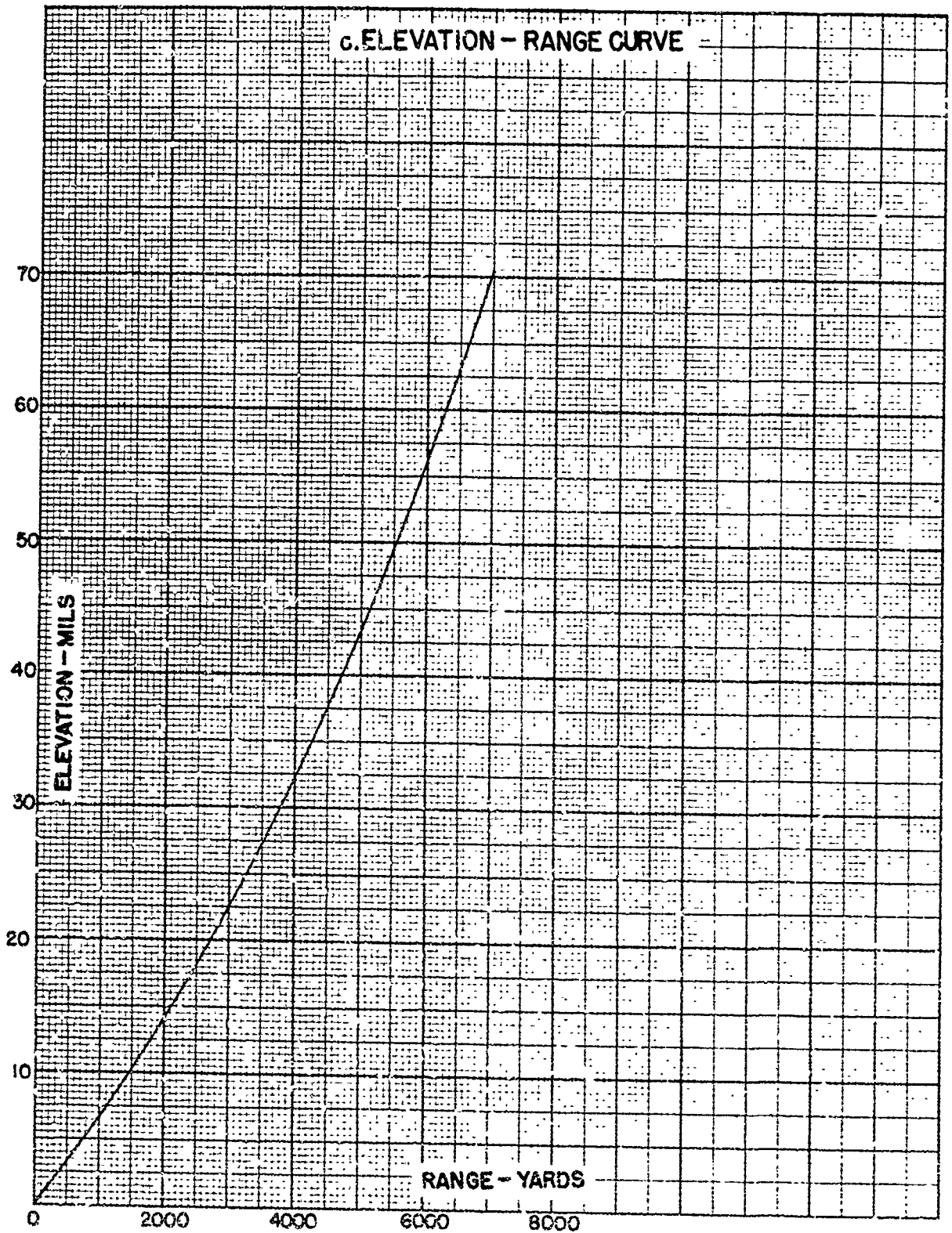

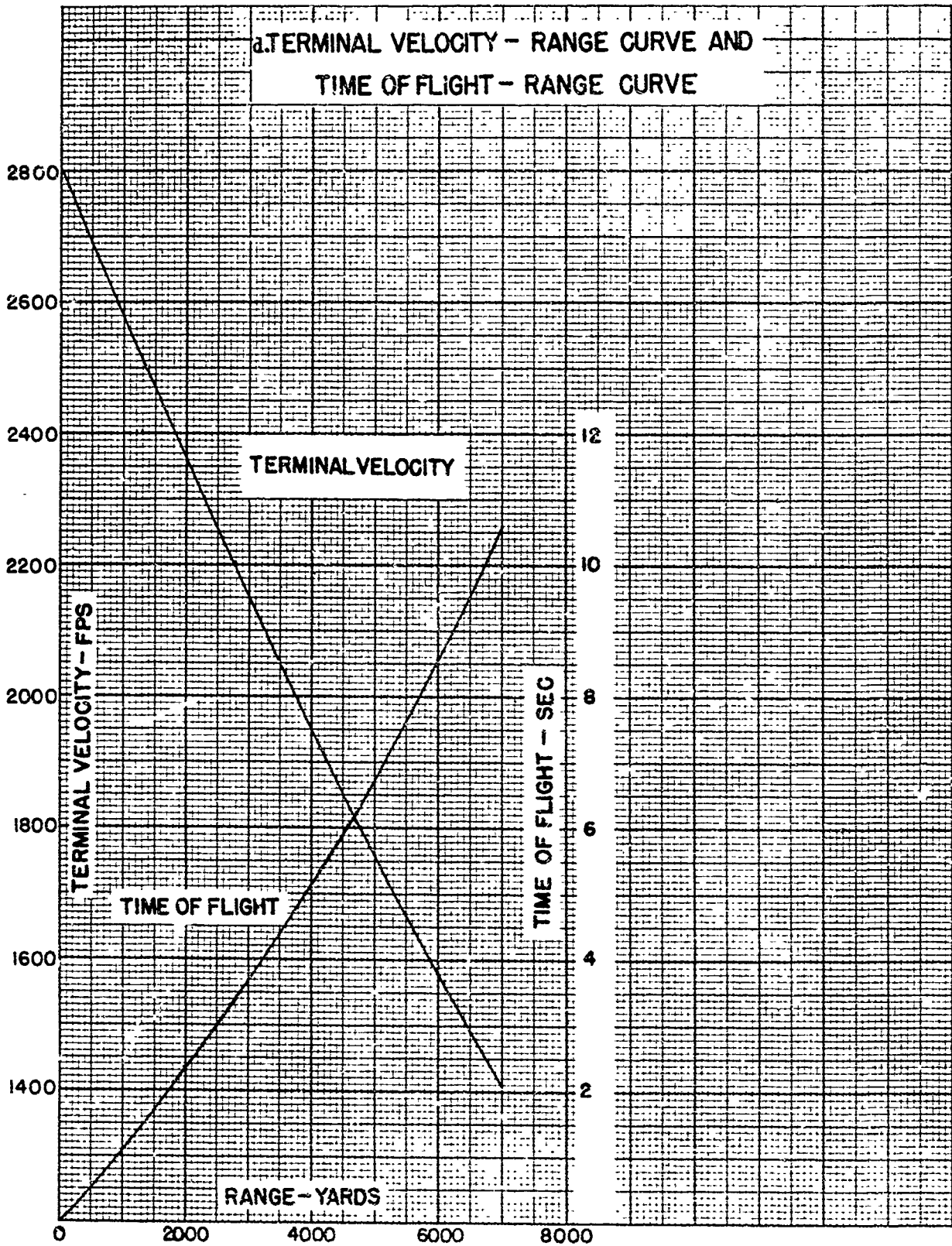

SECTION V
EFFECT DATA

Penetration - - - - - Paragraph
8

8. Penetration. According to OCM item 26320, the 90-mm AP Shot T33 with a muzzle velocity of 2800 fps will penetrate the front glacis plate of the German 'Panther' Tank (Panzerkampfwagen V). The armor plate penetration - velocity curves, taken from Vol. III of "Terminal Ballistic Data", are shown on the next page.

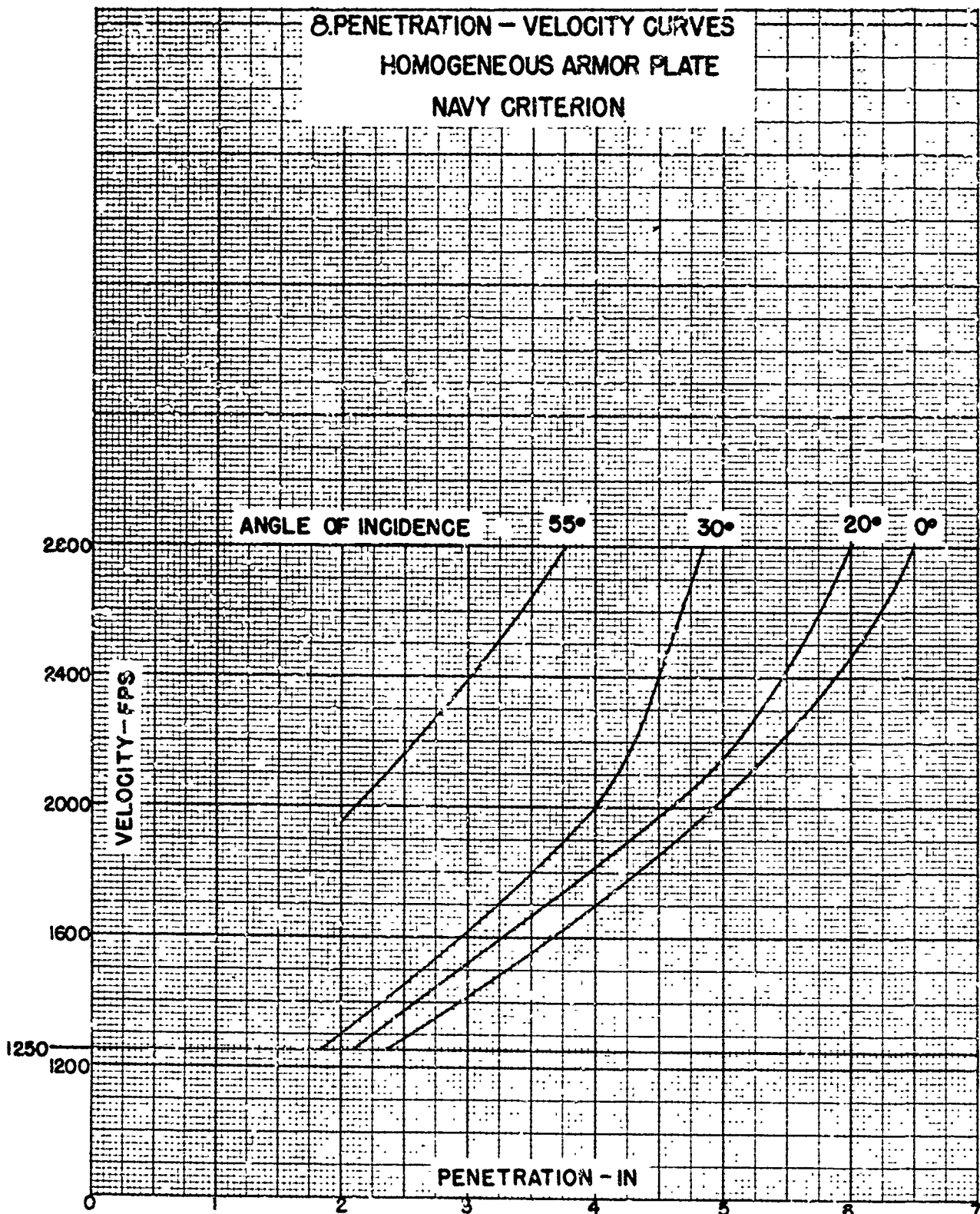

Ballistic Research Laboratories
 Handbook of Ballistic and
 Engineering Data for Ammunition,
 No. 90-1-58

Ballistic Research Lab.
 Aberdeen Proving Ground,
 Maryland.
 8 February 1949

BALLISTIC AND ENGINEERING DATA
 for
 Shell, HE, 90-mm, M58 and M58B1
 with
 Fuze, MT, M43A5

<u>Section</u>	<u>Paragraphs</u>
I	General ----- 1
II	Description ----- 2 - 4
III	Interior ballistic data ----- 5 - 6
IV	Exterior ballistic data ----- 7 - 8

SECTION I
GENERAL

	<u>Paragraph</u>
Purpose - - - - -	1

1. Purpose. The purpose of this number of the handbook is to furnish a concise collection of information regarding the shape, dynamics and ballistics of the 90-mm High Explosive Shell M58 and M58B1 with the Mechanical Time Fuze M43A5. This information is collected from the drawings, reports and firing tables pertaining to this ammunition.

ALL MEASUREMENTS IN CALIBERS
1 CAL. = 3.543"

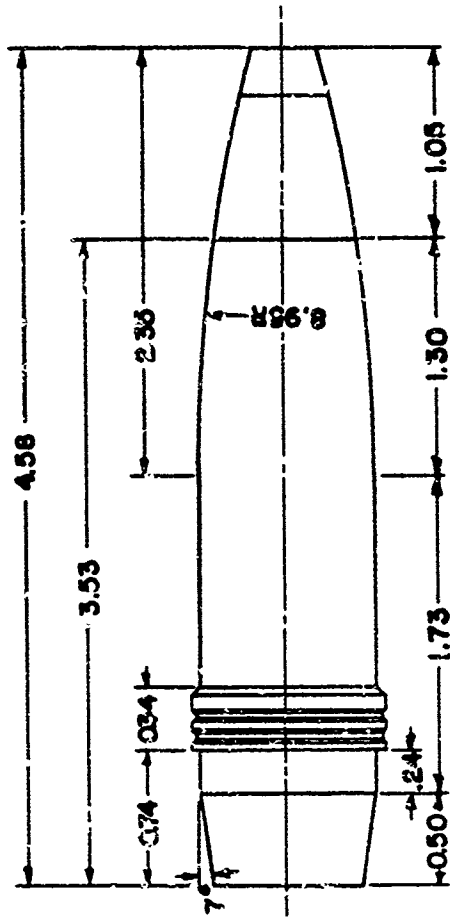

SHELL, HE, 90-MM, M58 AND M58BI
FUZE, MT, M43A5

SECTION II
DESCRIPTION

	<u>Paragraph</u>
Drawings - - - - -	2
Dimensions - - - - -	3
Physical characteristics - - - - -	4







2. Drawings.

Shell: Metal parts assembly and details	75-18-39
Booster M20: Assembly and details	73-2-112
Fuze: Assembly and details	73-7-29

3. Dimensions.

Boattail: Angle	7°00'
Length	0.50 cal
Band: Width	0.34 cal
Distance from base	0.74 cal
Distance from boattail	0.24 cal
Cylindrical body: Length	1.73 cal
Ogive: Length	1.30 cal
Radius of arc	8.95 cal
Fuze: Outside length	1.05 cal
Length: Shell	3.53 cal
Shell and fuze	4.58 cal
Ogive and fuze	2.35 cal

4. Physical characteristics.

Mean weight: Marking 	20.87 lb
Marking  	(Standard) 21.00 lb
Marking   	21.33 lb
Base to center of gravity*	1.789 cal
Axial moment of inertia*	0.2528 lb.ft ²
Transverse moment of inertia*	2.499 lb.ft ²

*From Ballistic Research Laboratory Report No. 165.

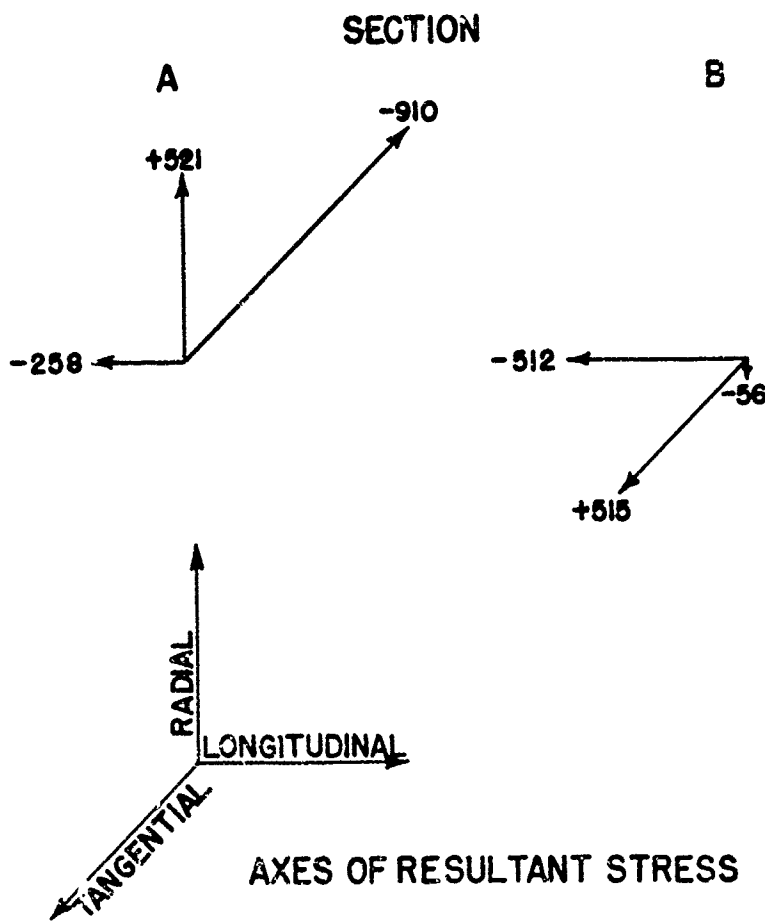
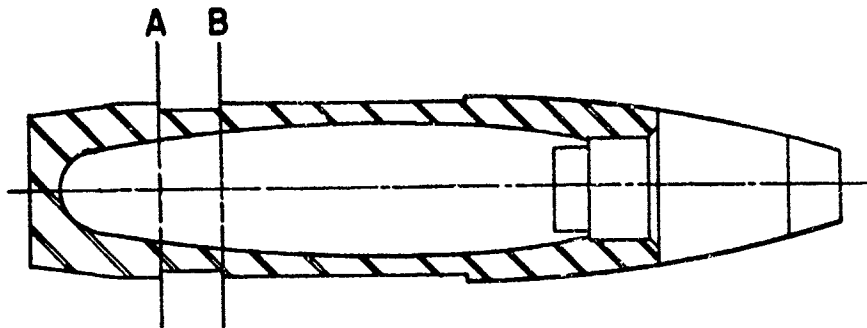

DIAGRAM OF RESULTANT STRESSES

SECTION III
INTERIOR BALLISTIC DATA

	<u>Paragraph</u>
Stresses - - - - -	5
Theoretical yaw in bore - - - - -	6

5. **Stresses.** The following table and the graphical representation on page 4 show the longitudinal, radial and tangential resultant stress at each of two sections: (A) the rear corner of the band seat and (B) the front of the band seat.

Guns, 90-mm	M1, M1A1, M2
Twist of rifling	1/32
Cross-sectional area of bore	10.114 sq in.
Rated maximum pressure	38,000 psi
Total weight of projectile	21.00 lb
Muzzle velocity	2,800 fps
Density of filler (TNT)	0.057 lb per cu in.

<u>Resultant Stress*</u> 100 psi	<u>Section</u>	
	A	B
Longitudinal	-258	-512
Radial	+521	- 56
Tangential	-910	+515

* + denotes tension, - denotes compression.

6. **Theoretical yaw in bore.**

Minimum	3 min
Maximum	5 min

SECTION IV
EXTERIOR BALLISTIC DATA

	<u>Paragraph</u>
Aerodynamic data - - - - -	7
Firing table data - - - - -	8

7. Aerodynamic data.

a. Drag. The trajectories for the 90-mm Guns M1, M1A1 and M2, on antiaircraft mounts, were based on the G_2 drag function. The form factors, determined from range firings, are given in paragraph 8a.

b. Stability. Ballistic Research Laboratories Report No. 165, "Stability of 90-mm Shell TC", gives the results of stability firings of the HE Shell M58 (T3) with inert Fuze M48 from the 90-mm Gun T2, which was rifled with a twist of one turn in 30 calibers. From these results, the following data were calculated for the HE Shell M58, with MT Fuze M48, fired from the 90-mm Guns M1, M1A1 and M2:

Muzzle Velocity	2800 fps
Twist of rifling	1/32
Stability factor	1.33
Moment coefficient, K_M	1.10

c. Drift. The deflection due to drift, for a muzzle velocity of 2700 fps and a twist of rifling of one turn in 32 calibers, is tabulated in FT 90AA-A-1, Part 2, Tables C-1 and C-2.

8. Firing table data. FT 90AA-A-1

Guns, 90-mm, M1, M1A1 and M2 on antiaircraft mount.

Twist of rifling: uniform 1/32.

Muzzle velocity: 2700 fps.

OCM item 15646 standardized the 90-mm HE Shell M58 for the 90-mm Gun M1. OCM item 15670 standardized the complete round, including the HE Shell M58 and the Cartridge Case M19, for the 90-mm Gun M1. Reclassification of the HE Shell M58 as limited standard was recommended by OCM item 16844 and approved by OCM item 16962. The characteristics of the 90-mm Guns M1A1 and M2 are the same as those of the 90-mm Gun M1.

a. Trajectory data. Trajectory and fire order curves for a muzzle velocity of 2700 fps are given on TC 90AA-A-1. With the fuze set "safe":

Maximum horizontal range	17,580 yd
Maximum ordinate	12,375 yd

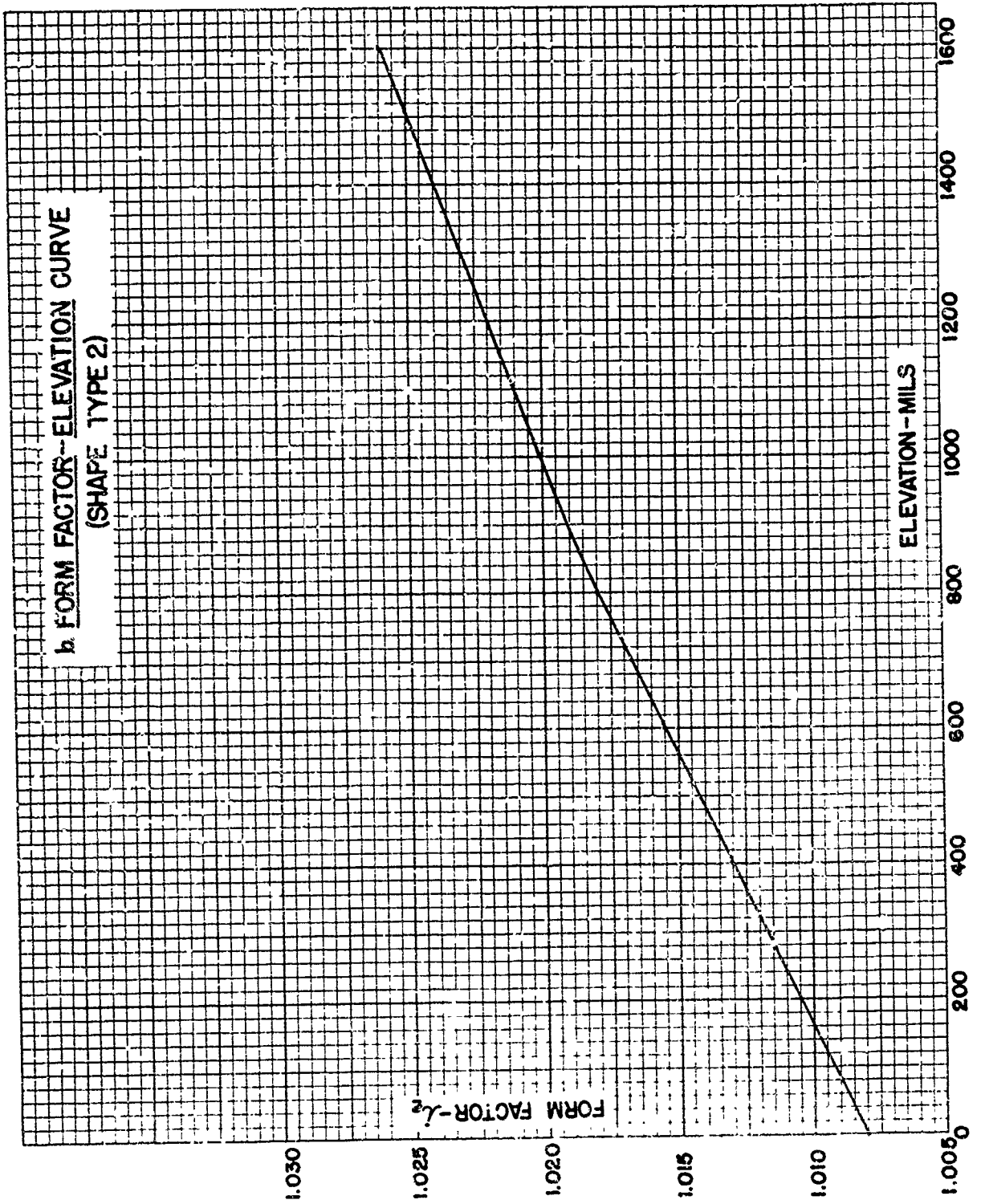

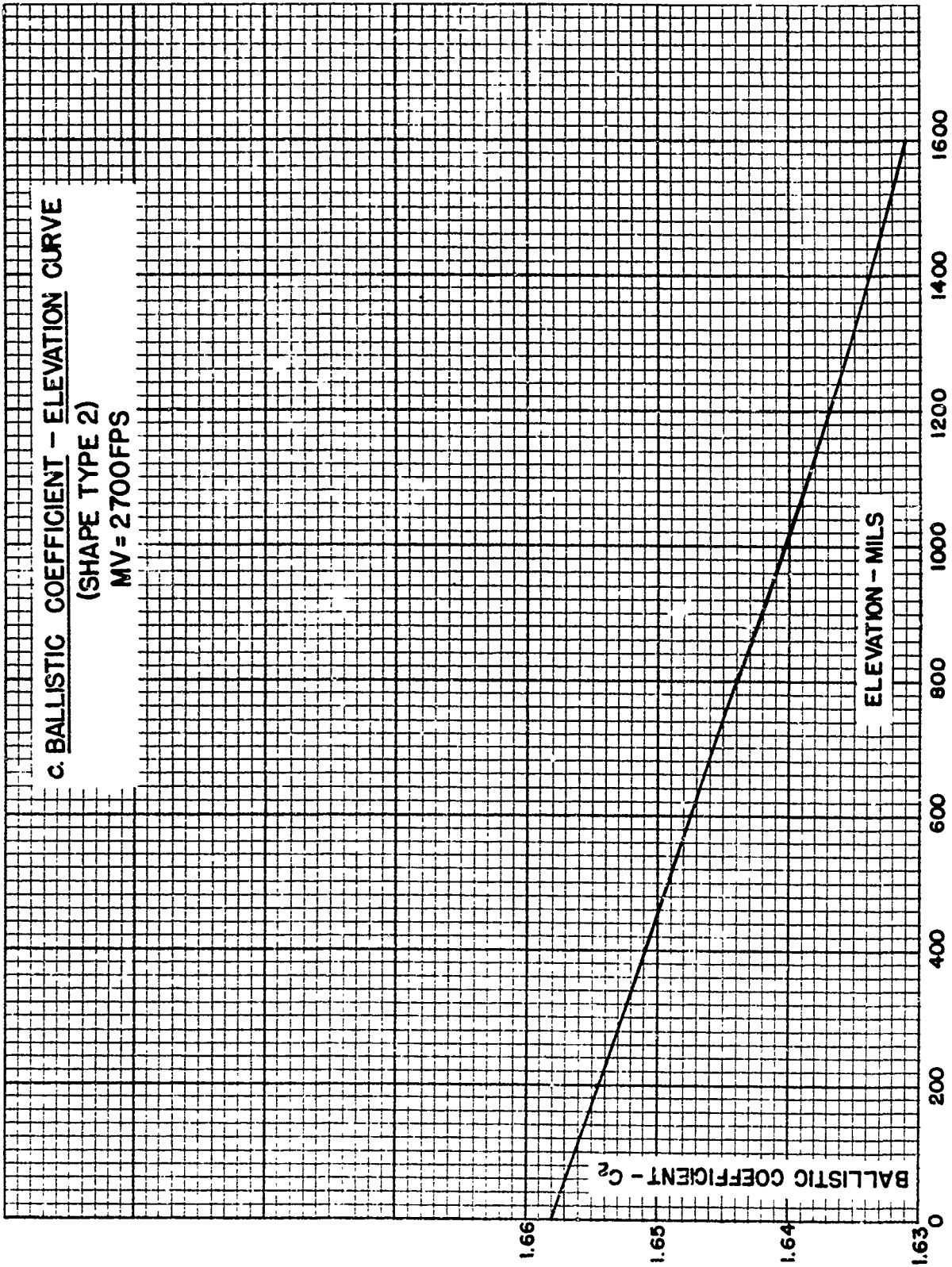

Ballistic Research Laboratories
Handbook of Ballistic and
Engineering Data for Ammunition,
No. 90-1-71

Ballistic Research Lab.
Aberdeen Proving Ground,
Maryland.
8 February 1949

BALLISTIC AND ENGINEERING DATA
for
Shell, HE, 90-mm, M71
with
Fuzes, MT, M43A5; PD, M48, M48A1, M48A2,
and M51A4; TSQ, M54 and M55A3; and CP, M78

<u>Section</u>	<u>Paragraphs</u>
I General -----	1
II Description -----	2 - 4
III Interior ballistic data -----	5 - 6
IV Exterior ballistic data -----	7 - 9
V Effect data -----	10 - 13

SECTION I
GENERAL

<u>Purpose</u> -----	<u>Paragraph</u>
	1

1. Purpose. The purpose of this number of the handbook is to furnish a concise collection of information regarding the shape, dynamics, ballistics and effects of the 90-mm High Explosive Shell M71 with the Mechanical Time Fuze M43A5, the Point Detonating Fuze M48, M48A1, M48A2 or M51A4, the Time and Superquick Fuze M54, and the Concrete Piercing Fuze M78. This information is collected from the drawings, reports, firing tables, and technical manuals pertaining to this ammunition.

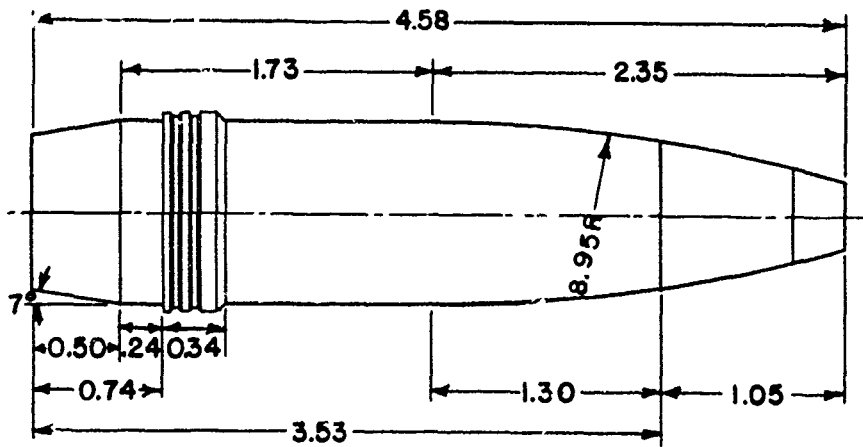

SHELL, HE, 90MM, M71
FUZE, MT, M43A5; PD, M48, M48AI OR M48A2; OR TSQ, M54

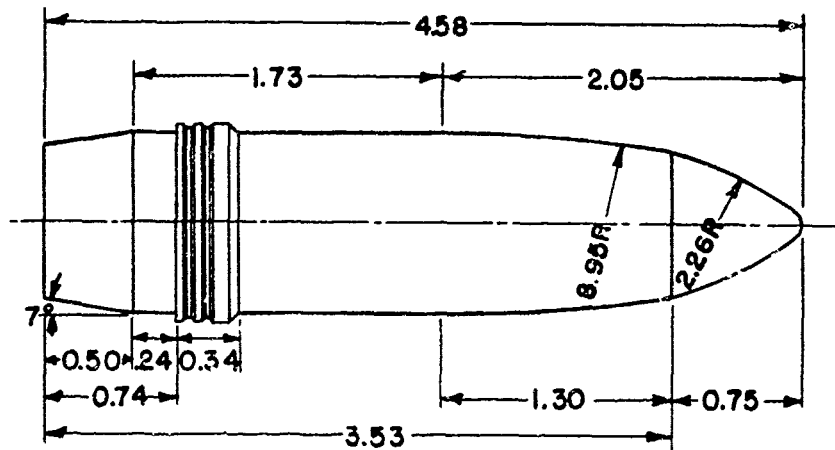

SHELL, HE, 90MM, M71
FUZE, CP, M78

ALL DIMENSIONS IN CALIBERS
1 CALIBER = 3.543"

**SECTION II
DESCRIPTION**

	<u>Paragraph</u>
Drawings - - - - -	2
Dimensions - - - - -	3
Physical characteristics - - - - -	4

2. Drawings.

Shell: Metal parts assembly	75-18-42
Booster, M20A1: Assembly and details	73-2-112
Booster, M21A4: Assembly	73-2-154
Fuze, MT, M43A5: Assembly and details	73-7-29
Fuze, PD, M48, M48A1 and M48A2: Assembly	73-2-140
Fuze, PD, M51A4: Assembly	73-2-145
Fuze, TSQ, M54: Assembly	73-3-154
Fuze, CP, M78: Assembly and details	73-2-214

Note: The MT, PD, and TSQ Fuzes require one of the Boosters; but the CP Fuze contains their working parts. The TSQ Fuze M54 and the Booster M21A4 are components of the TSQ Fuze M55A3, dwg 73-3-155.

3. Dimensions.

Boattail: Angle	7°00'
Length	0.50 cal
Band: Distance from boattail	0.24 cal
Distance from base	0.74 cal
Width	0.34 cal
Cylindrical body: Length	1.73 cal
Ogive: Length	1.30 cal
Radius of arc	8.95 cal
Shell, unfuzed: Length	3.53 cal
Fuze, MT, M43A5; PD, M48, M48A1, M48A2 or M51A4; or TSQ, M54:	
Outside length	1.05 cal
Ogive and fuze	2.35 cal
Shell and fuze	4.58 cal
Fuze, CP, M78: Outside length	0.75 cal
Radius of arc	2.26 cal
Ogive and fuze	2.05 cal
Shell and fuze	4.28 cal

4. Physical characteristics.

a. **MT, PD and TSQ Fuzes.** The weight, location of center of gravity, and moments of inertia of the HE Shell M71 with any of these fuzes are approximately the same as those of the Shell M71 (T8) with the MT Fuze M43, which are tabulated below.

Mean weight: Marking	■	(standard)	23.07 lb
Marking	■ ■		23.40 lb
Marking	■ ■ ■		23.73 lb
Base to center of gravity			1.742 cal
Axial moment of inertia			0.2753 lb.ft ²
Transverse moment of inertia			2.627 lb.ft ²

b. **CP Fuze.** The HE Shell M71 with the CP Fuze weighs 0.34 lb more than with the other fuzes. Its other characteristics would also be slightly different, but have not been measured.

**SECTION III
INTERIOR BALLISTIC DATA**

	<u>Paragraph</u>
Stresses - - - - -	5
Theoretical yaw in bore - - - - -	6

5. **Stresses.** The following table and the graphical representation on page 5 show the longitudinal, radial and tangential resultant stresses at each of three sections: (A) the rear corner of the band seat, (B) the front of the band seat, and (C) immediately behind the bourrelet.

Guns, 90-mm	M1, M1A1, M2, M3
Twist of rifling	1/32
Cross-sectional area of bore	10.114 sq in.
Rated maximum pressure	38,000 psi
Total weight of projectile	23.40 lb
Muzzle velocity	2,700 fps
Density of filler (TNT)	0.057 lb per cu in.

<u>Resultant Stress*</u> 100 psi	<u>Section</u>		
	A	B	C
Longitudinal	-192	-345	-310
Radial	+328	- 53	- 19
Tangential	-625	+354	+291

* + denotes tension, - denotes compression.

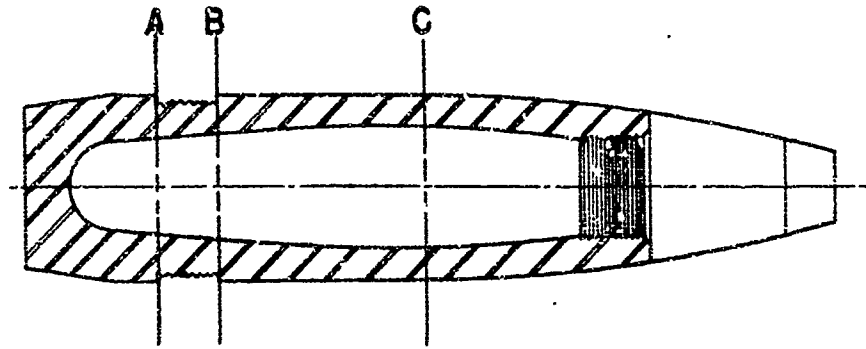

SECTION

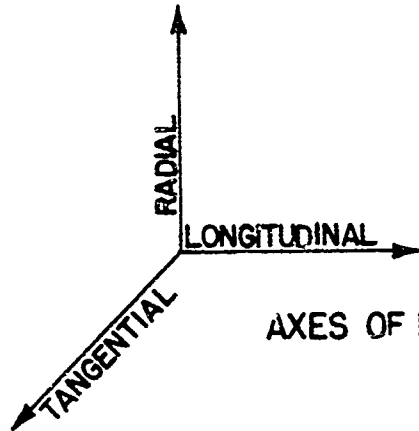
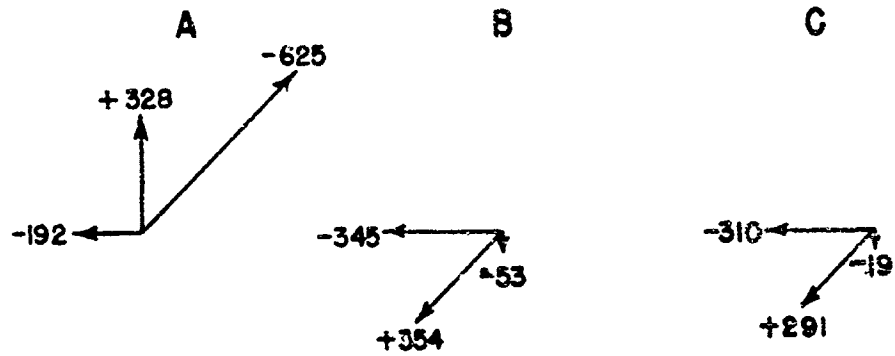

AXES OF RESULTANT STRESS

DIAGRAM OF RESULTANT STRESSES

6. Theoretical yaw in bore.

Minimum	3 min
Maximum	5 min

SECTION IV
EXTERIOR BALLISTIC DATA

	<u>Paragraph</u>
Aerodynamic data - - - - -	7
Antiaircraft firing table data - - - - -	8
Ground firing table data - - - - -	9

7. Aerodynamic data.

a. Drag.

(1) The antiaircraft trajectories were computed with the drag coefficient shown on page 7, which was determined by AA range firings of the HE Shell M71 with the MT Fuze M43A3 as explained in BRL Report No. 507, "The Experimental Basis and Computing Methods used in the Preparation of Firing Table FT 90AA-B-3". The form factor relative to this drag coefficient is 1.000; hence the ballistic coefficient is 1.864.

(2) The trajectories for the HE Shell M71 with the PD and TSQ Fuzes were based on the G_2 drag function. The form factor and ballistic coefficient are shown in par. 9a and b; at the muzzle:

Velocity	2700 fps
Ballistic Coef. C_2	1.79
Form Factor, i_2	1.041
Drag Coef. K_D	0.109

(3) Comparative firings at 3° elevation showed that the range-elevation relation for the HE Shell M71 with the CP Fuze M78 could be obtained from that with the PD Fuze M48 by decreasing the muzzle velocity 27 fps and applying an effect equal to that of an increase of 12.16 per cent in air density. The numerical average of the effects due to an increase and a decrease in density (see par. 9n) was used for this purpose.

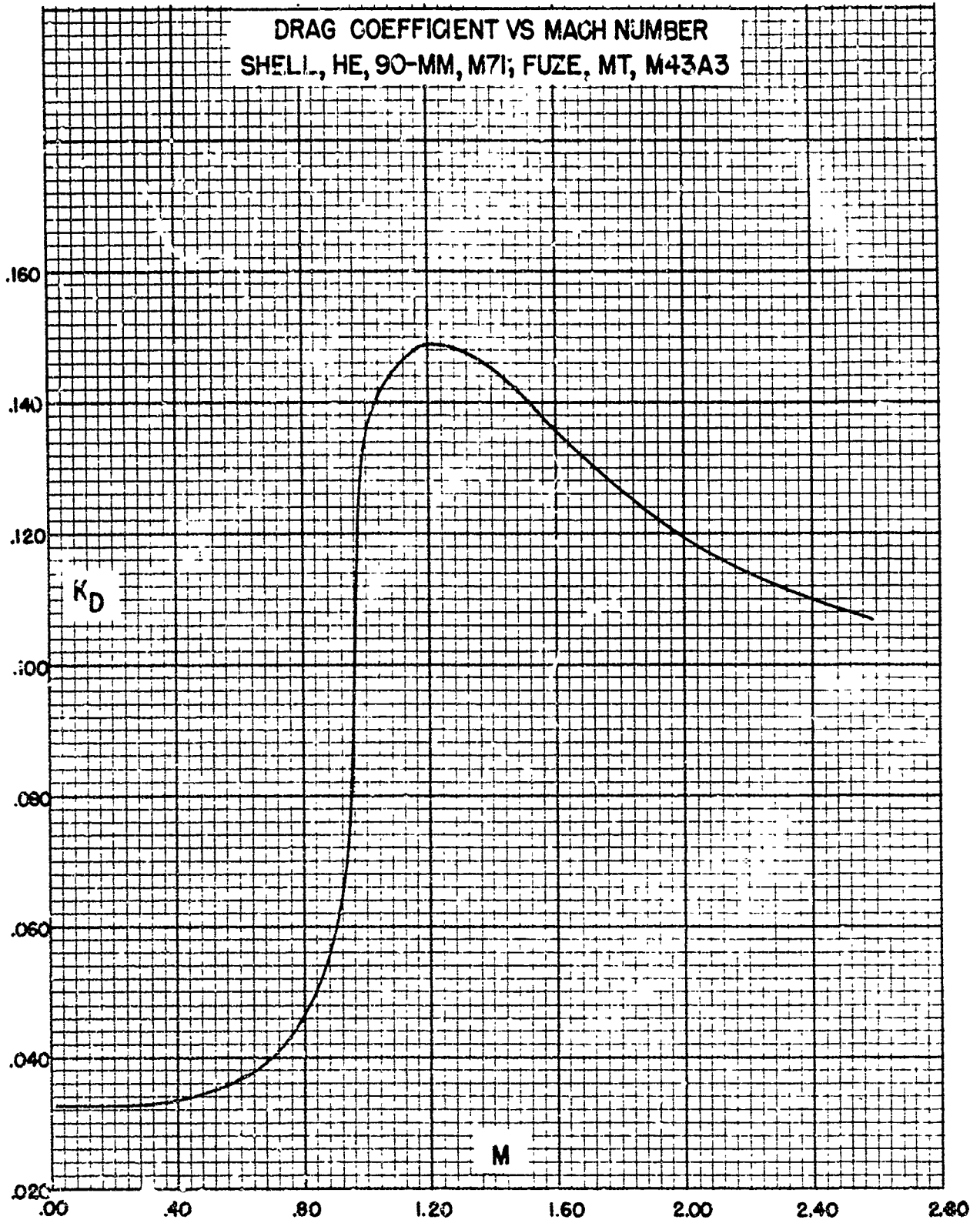

b. Stability. BRL Report No. 236, "Stability of 90-mm Shell T8", gives the results obtained from stability firings of inert-loaded Shell M71 (T8) with the MT Fuze M43 from the 90-mm Gun M1:

Muzzle Velocity	2700 fps
Moment coef. K_M	1.25
Twist of rifling	1/32
Stability factor	1.32

c. Axial couple. BRL Report No. 408, "Loss of Spin and Skin Friction Drag of Projectiles", gives the results obtained from firings of a 90-mm HE Shell M71 with a radio spin sonde in a dummy fuze having the same shape as the MT Fuze M43:

Average velocity	1640 fps
Reynolds' number (based on avg vel. and caliber)	2.95×10^6
Axial couple coefficient, K_A	0.0059
Surface (without base)	149.3 sq in.
Skin friction drag coefficient, C_{DF}'	0.00198

8. Antiaircraft firing table data. FT 90AA-B-3.

Guns, 90-mm, M1, M1A1 and M2 on AA Mounts.
Twist of rifling: 1/32
Muzzle velocity: 2700 fps
Fuze: MT M43A5

OCM items 16844 and 16962 recommended and approved standardization of the HE Shell M71.

a. Form factor. $i = 1.000$ relative to the drag coefficient for the 90-mm HE Shell M71 (see p. 7).

b. Ballistic coefficient. $C = 1.864$ relative to the drag coefficient for the 90-mm HE Shell M71 (see p. 7).

c. Trajectory data. A Trajectory and Fuze Setter Chart is included with the firing table. With the fuze set 'safe':

Maximum horizontal range	19,560 yd
Maximum vertical range	13,426 yd

9. Ground firing table data.

FT 90AA-B-3, FT 90-C-3, and FT 90-F-1.

Guns, 90-mm, M1, M1A1, M2, M3 and M26 on AA Mounts, Gun Motor Carriages, or Tanks.

Twist of rifling: 1/32.

Muzzle Velocity: 2700 fps

Fuzes: PD, M48, M3A1, M48A2 and M51A4; TSCQ, M54; and CP, M78 (except as noted, the data in this paragraph do not pertain to the CP fuze).

OCM items 18696 and 18930 recommended and approved authorization of the HE Shell M71 with the PD Fuze M48 for use with the 90-mm Gun M1 on a self-propelled mount.

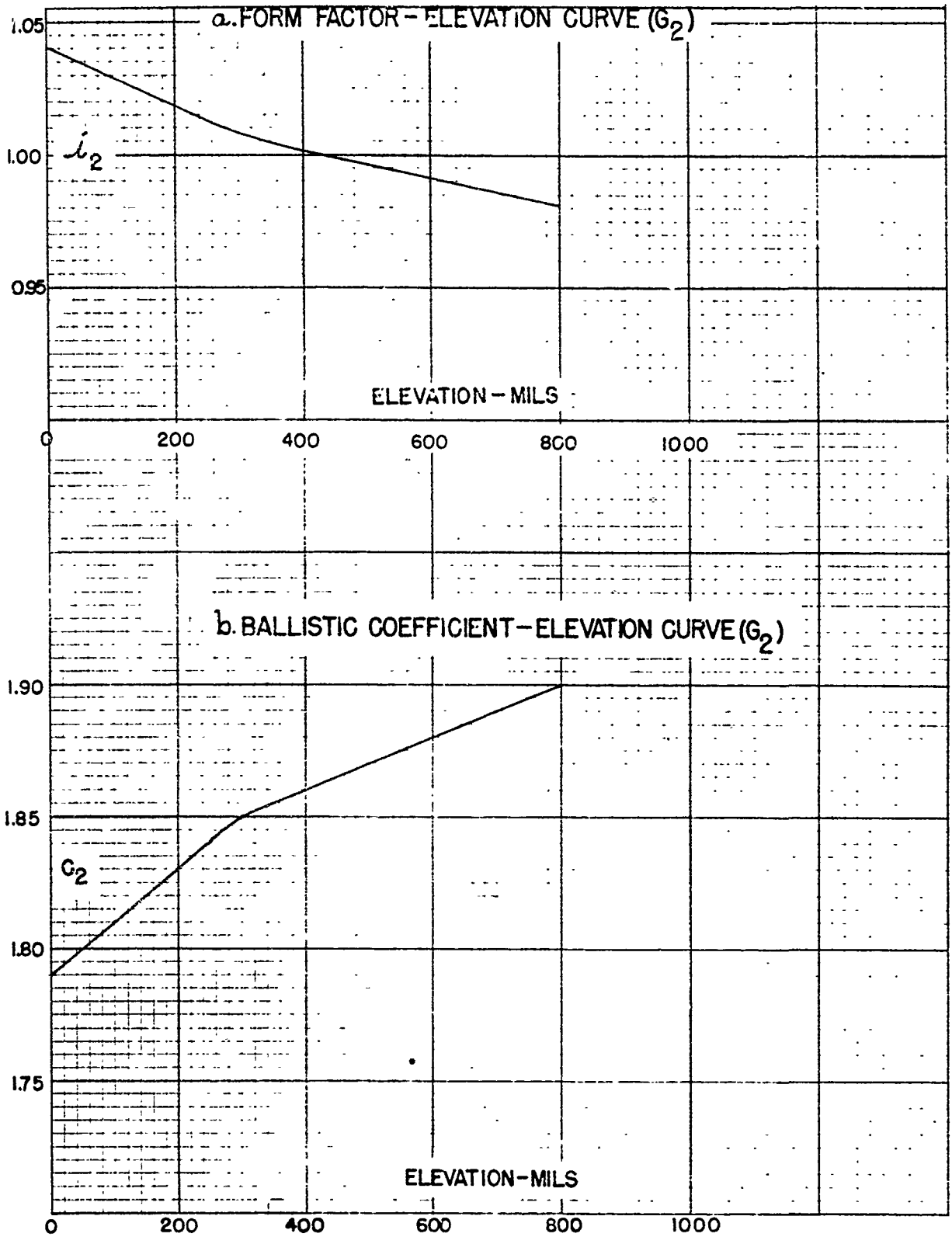

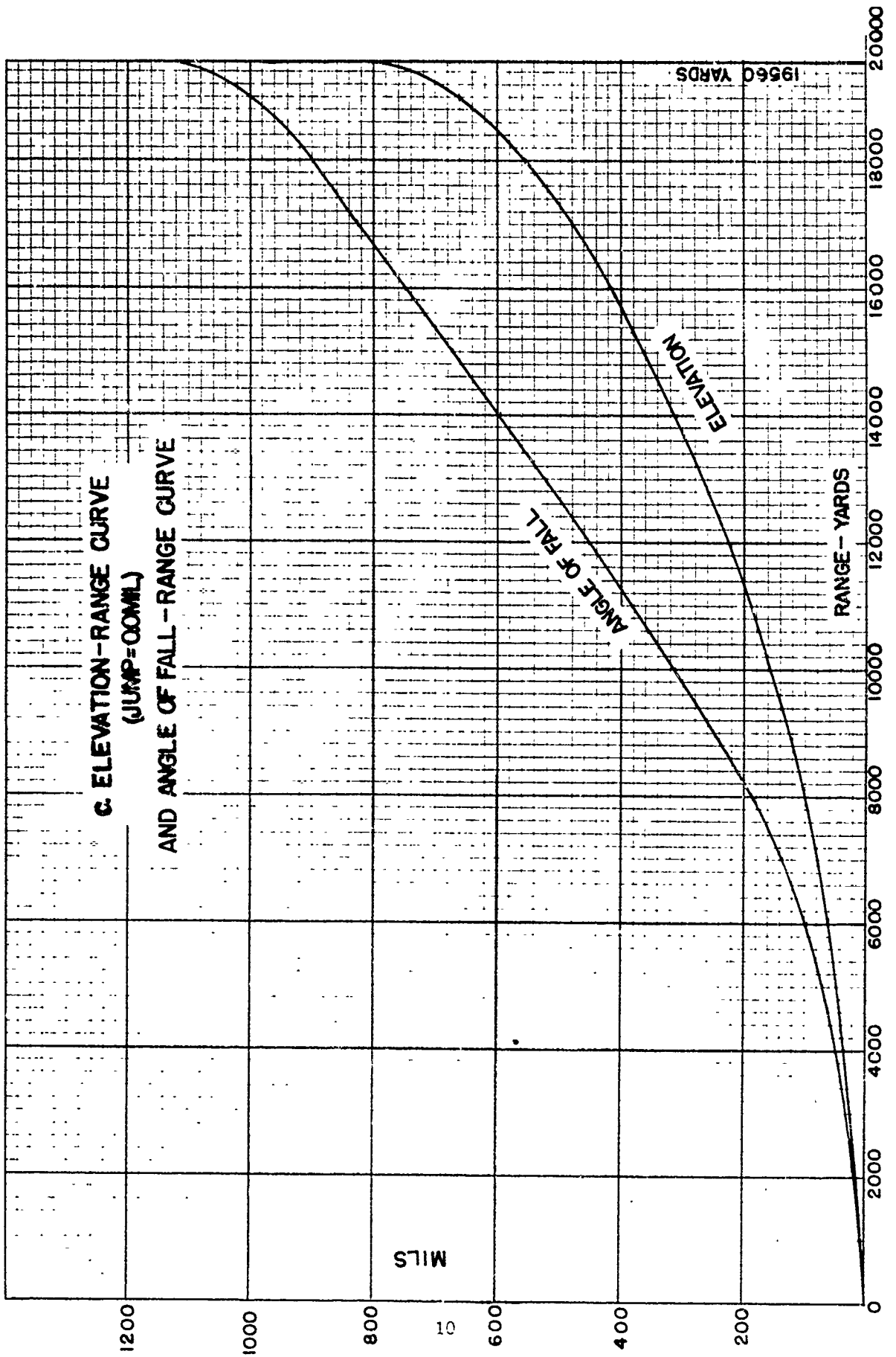

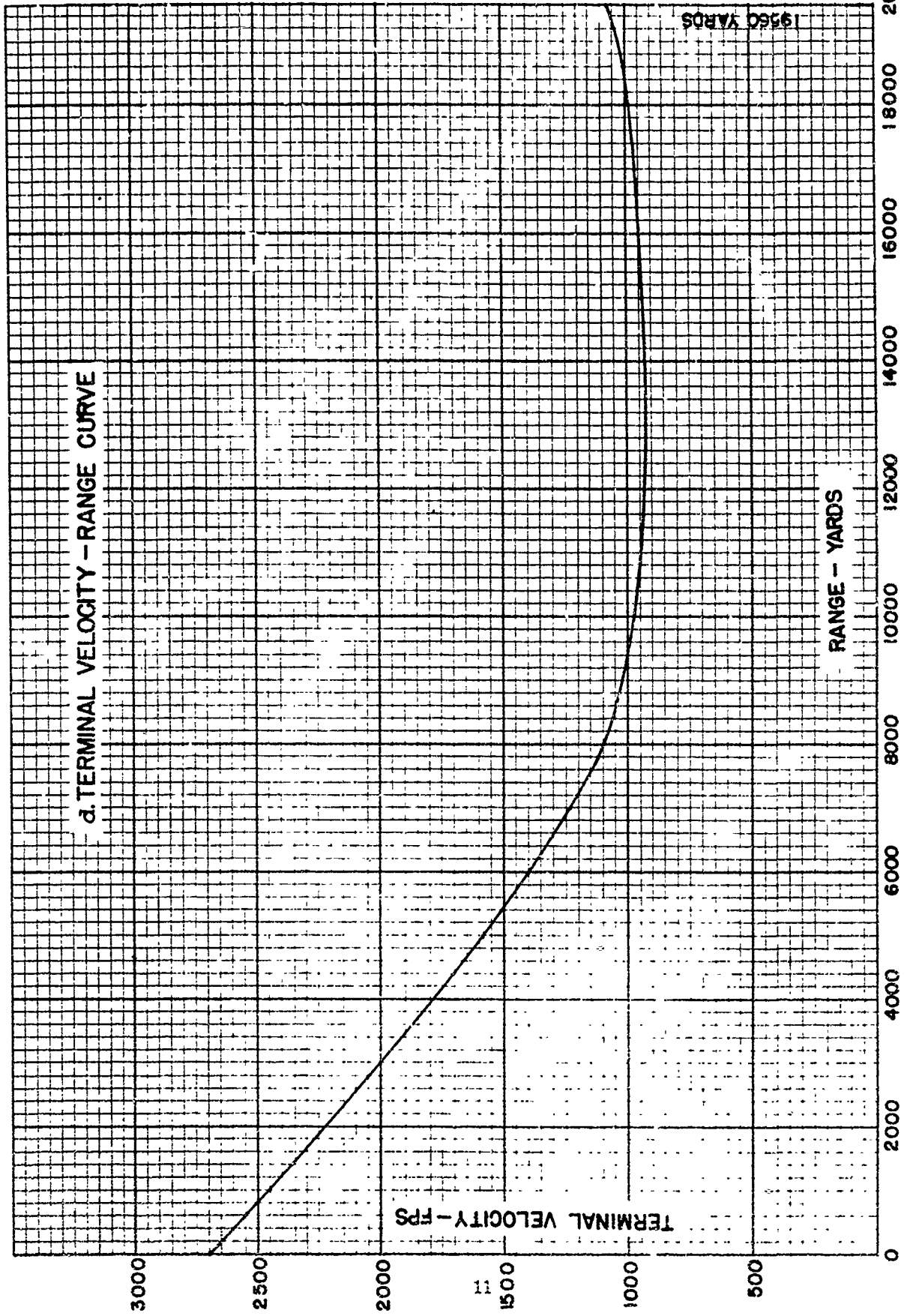

a. TERMINAL VELOCITY - RANGE CURVE

19560 YARDS

TERMINAL VELOCITY - FPS

RANGE - YARDS

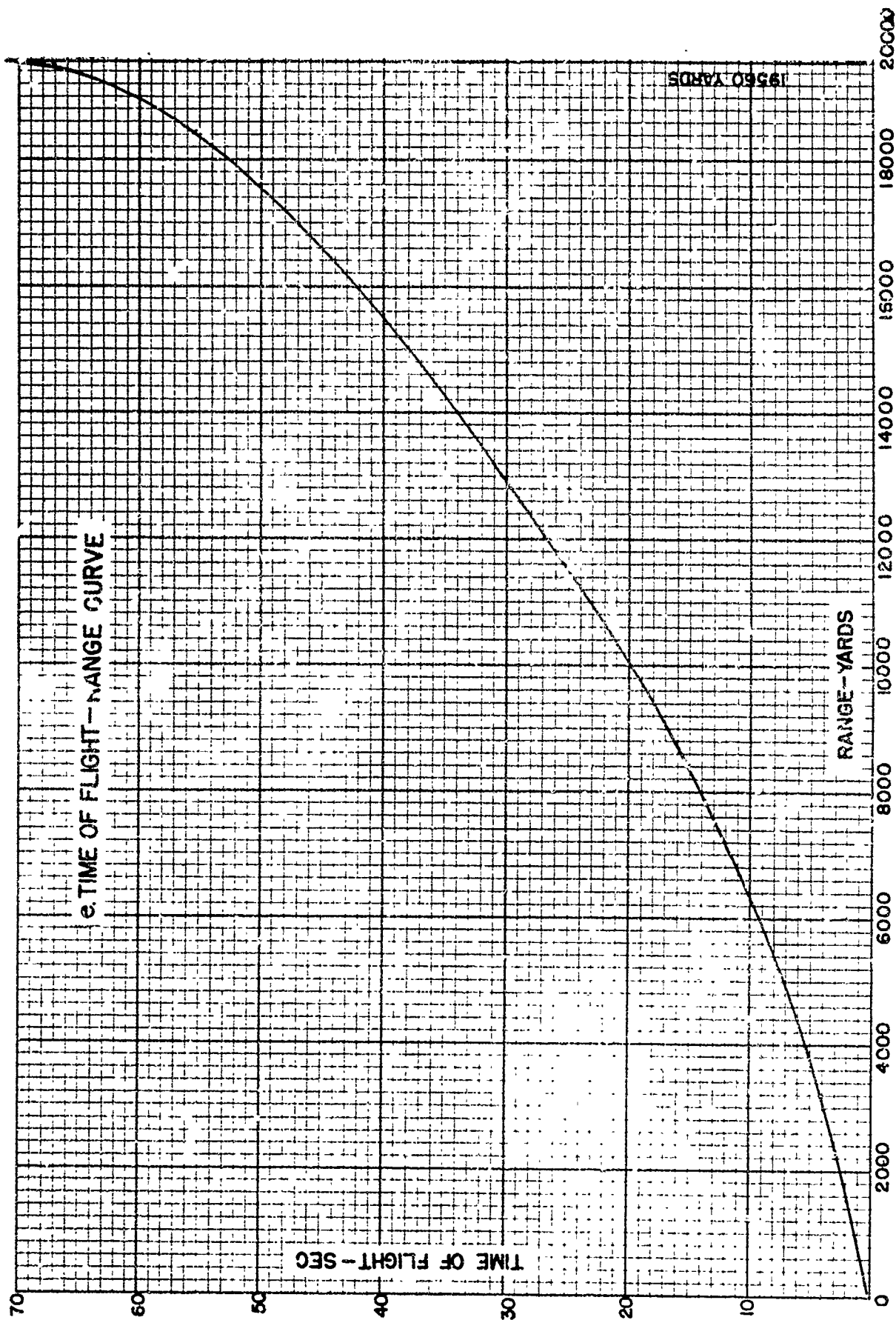

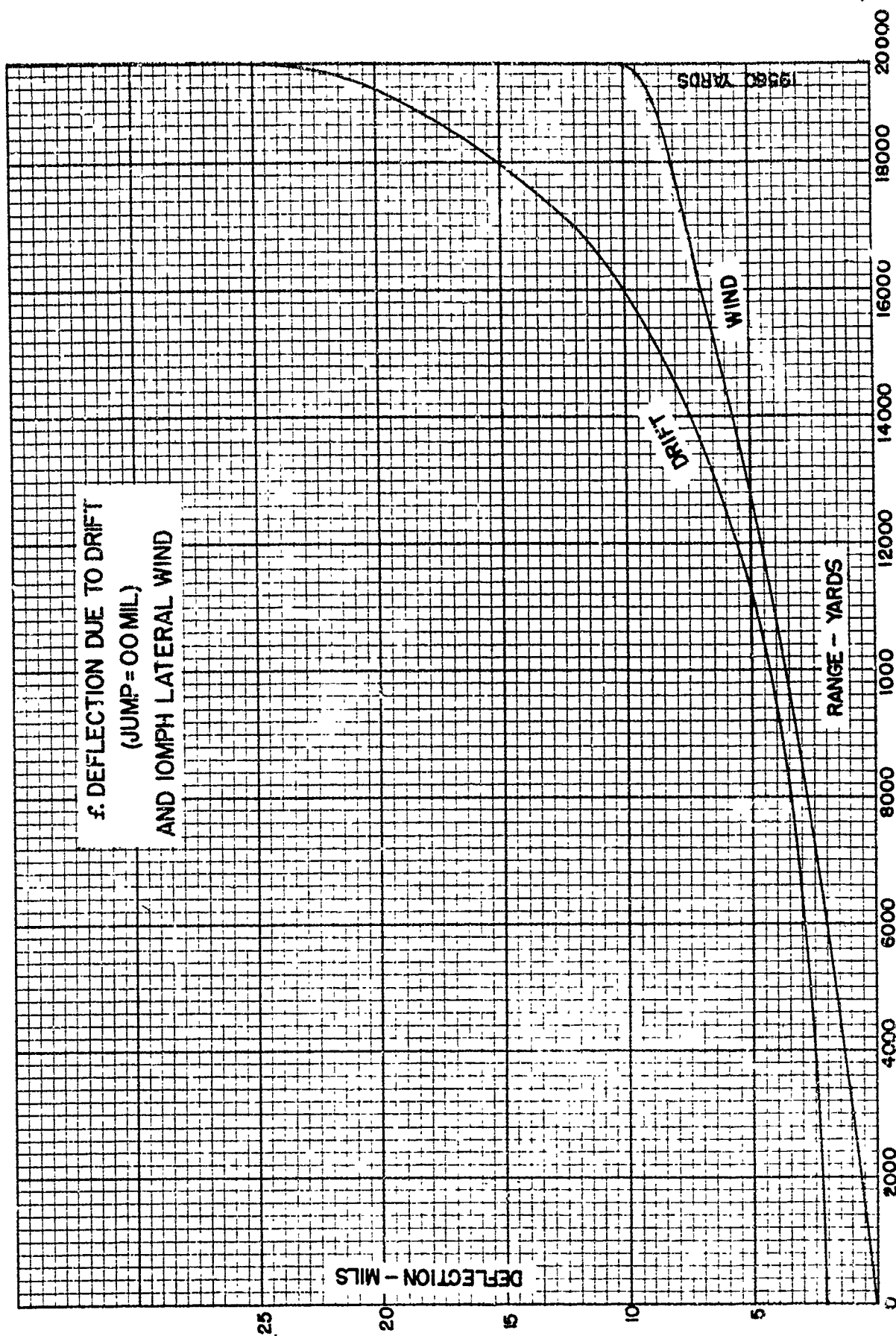

f. DEFLECTION DUE TO DRIFT
(JUMP = 00 MIL)
AND 10MPH LATERAL WIND

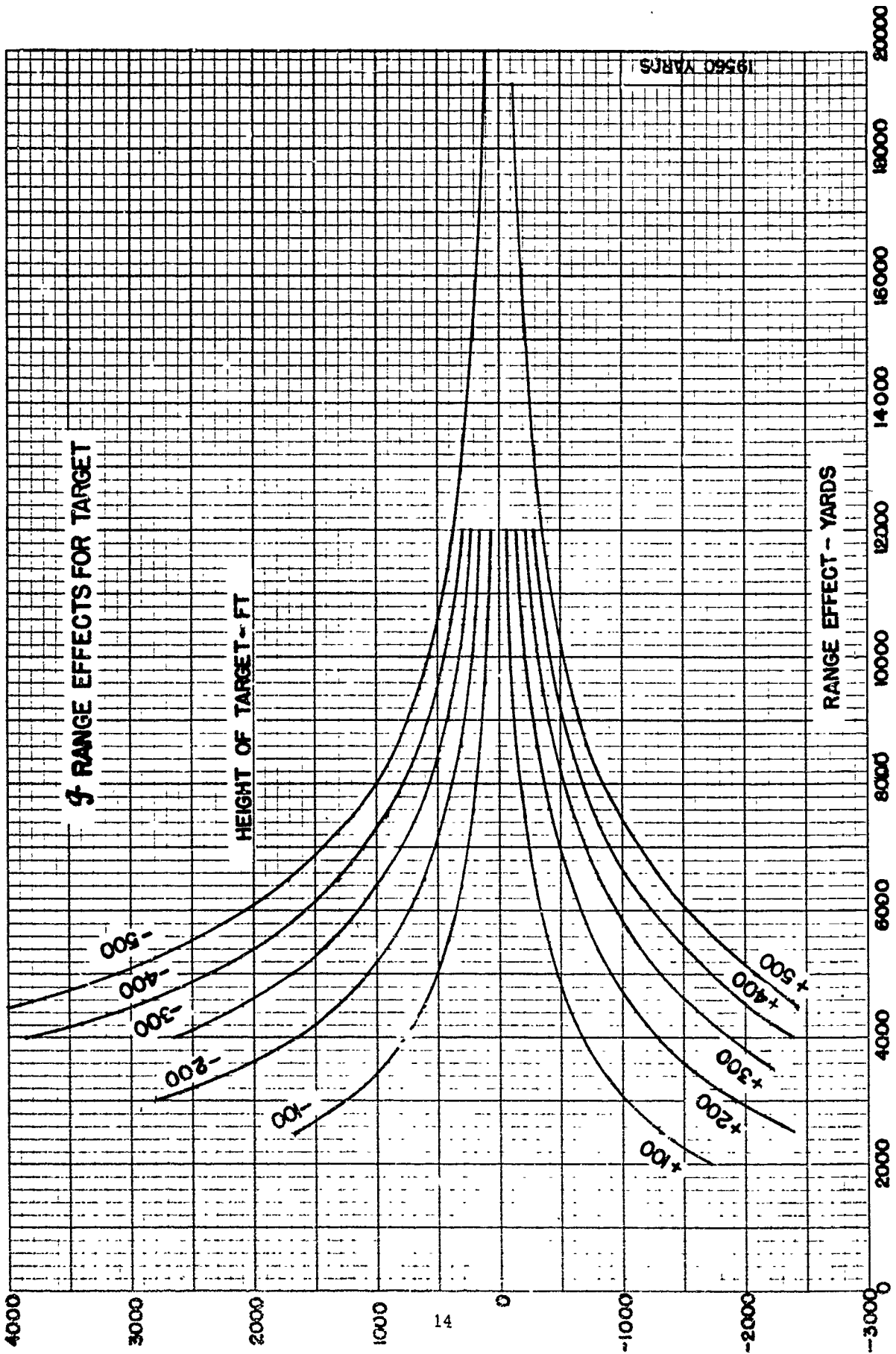

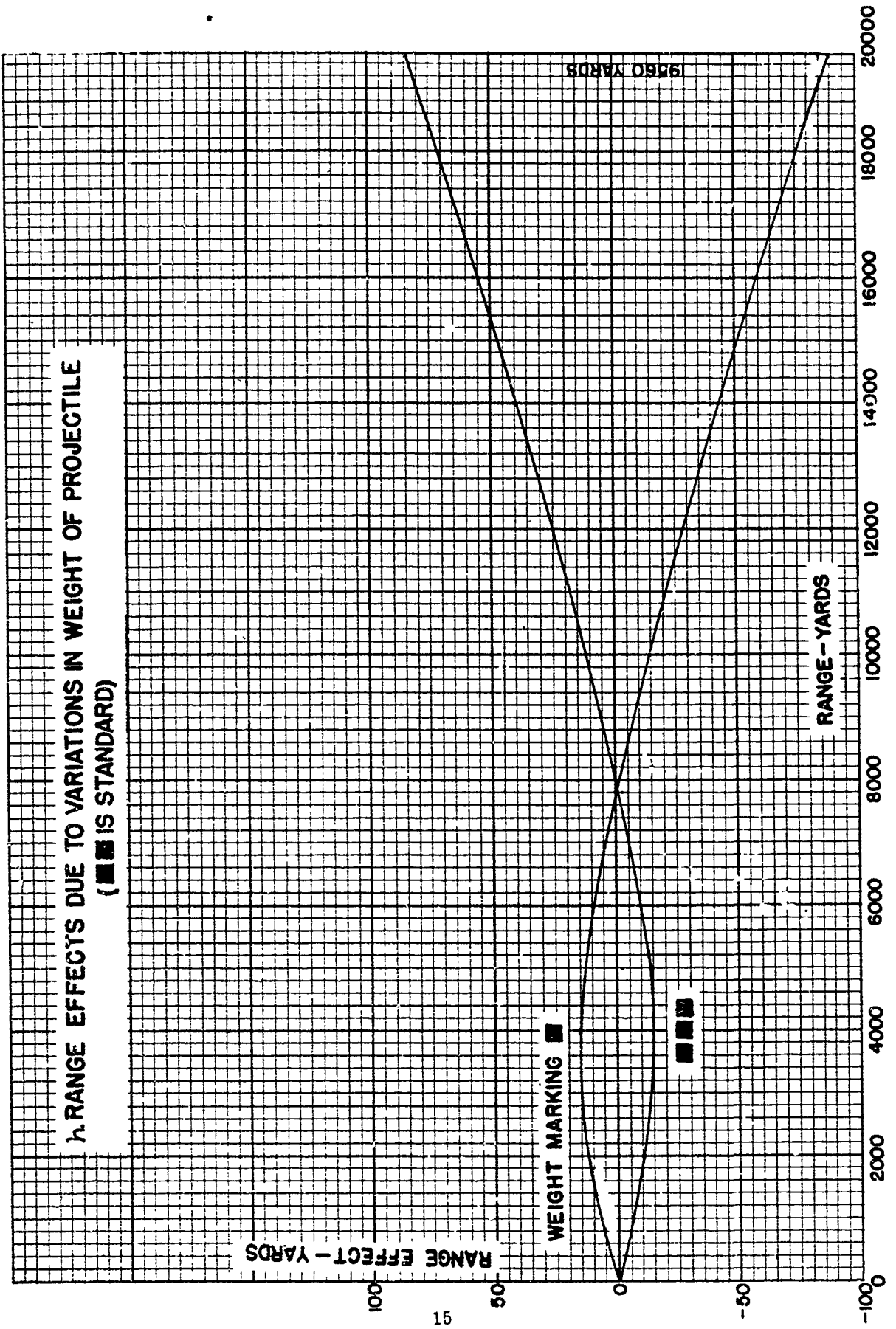

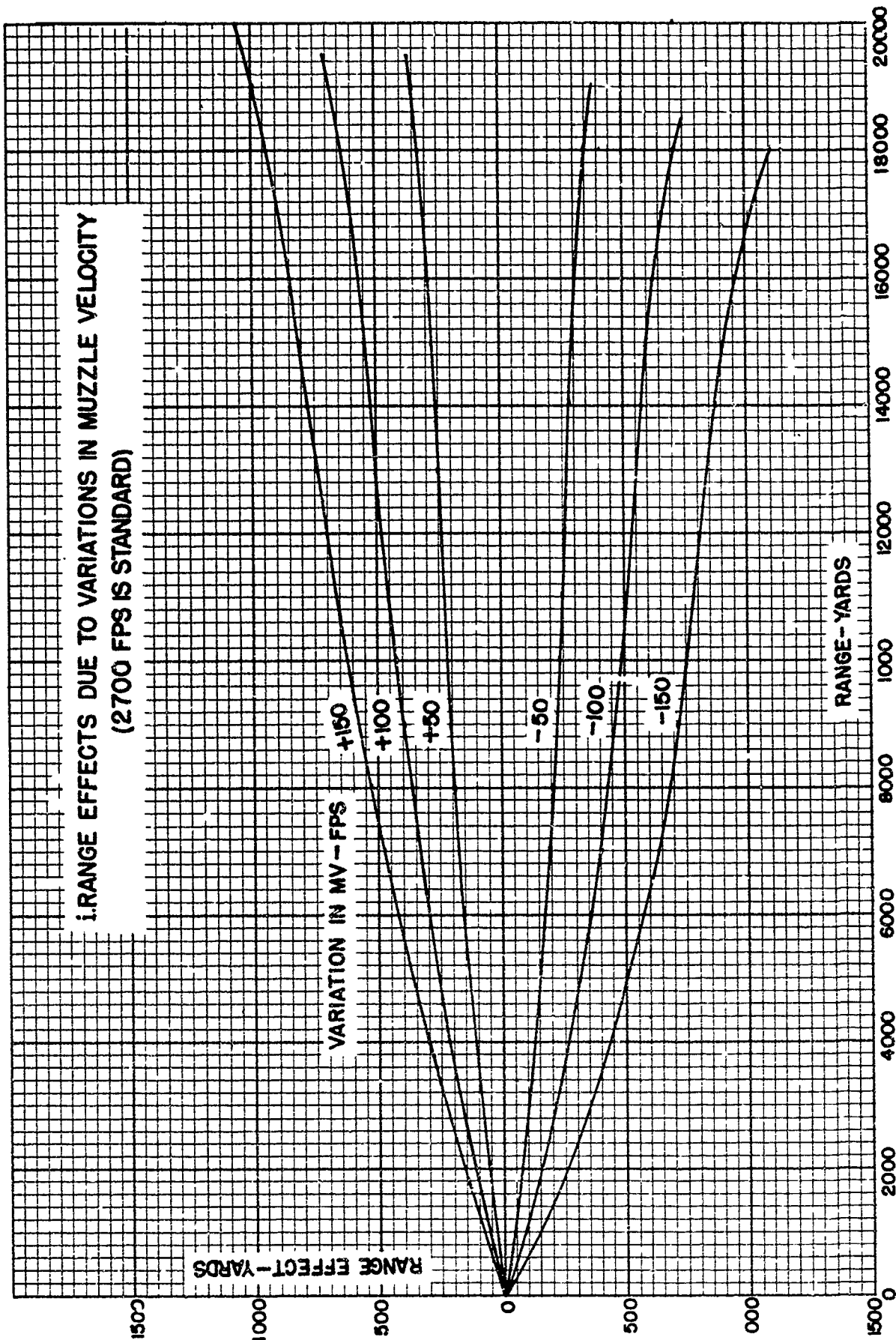

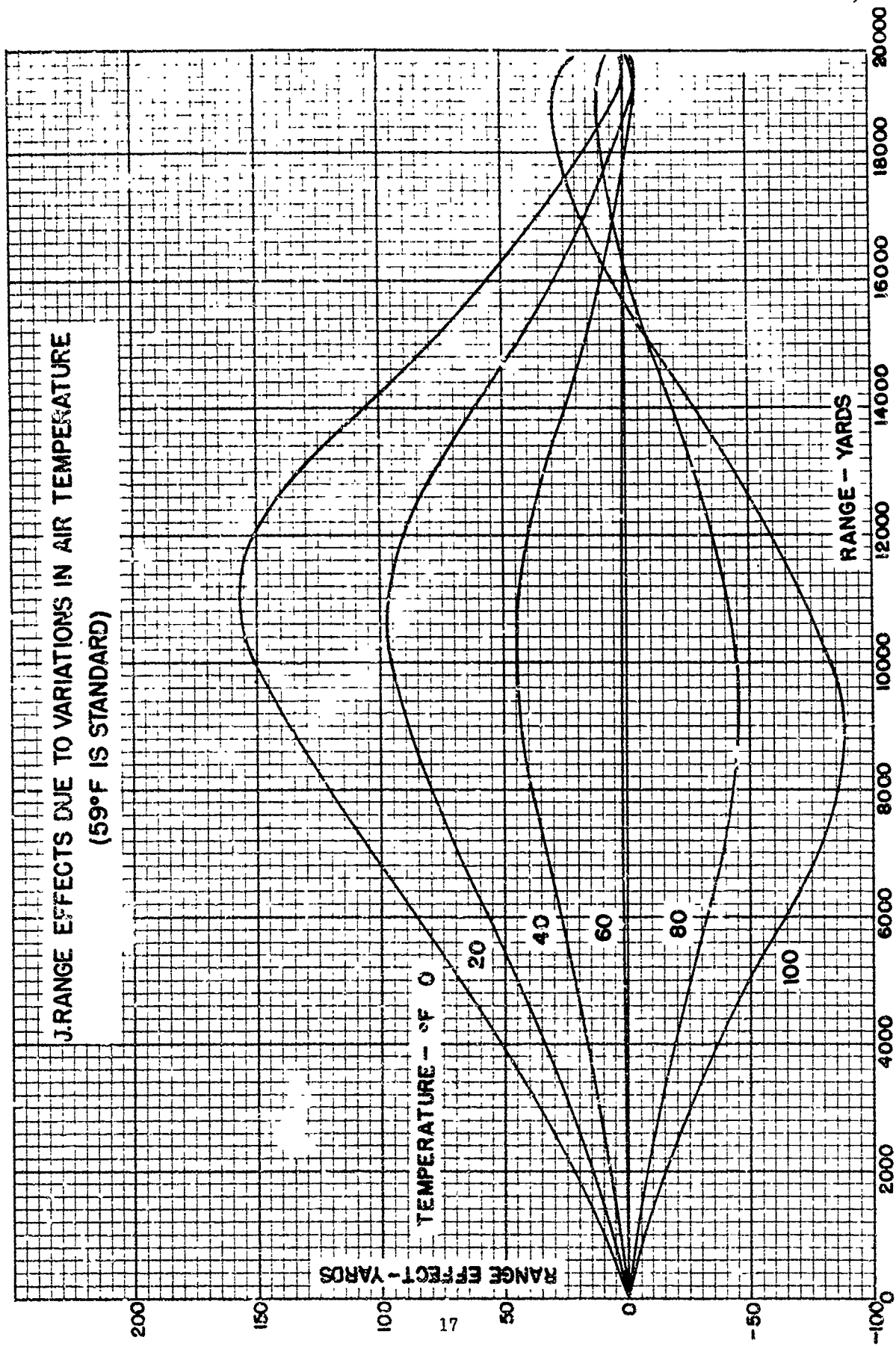

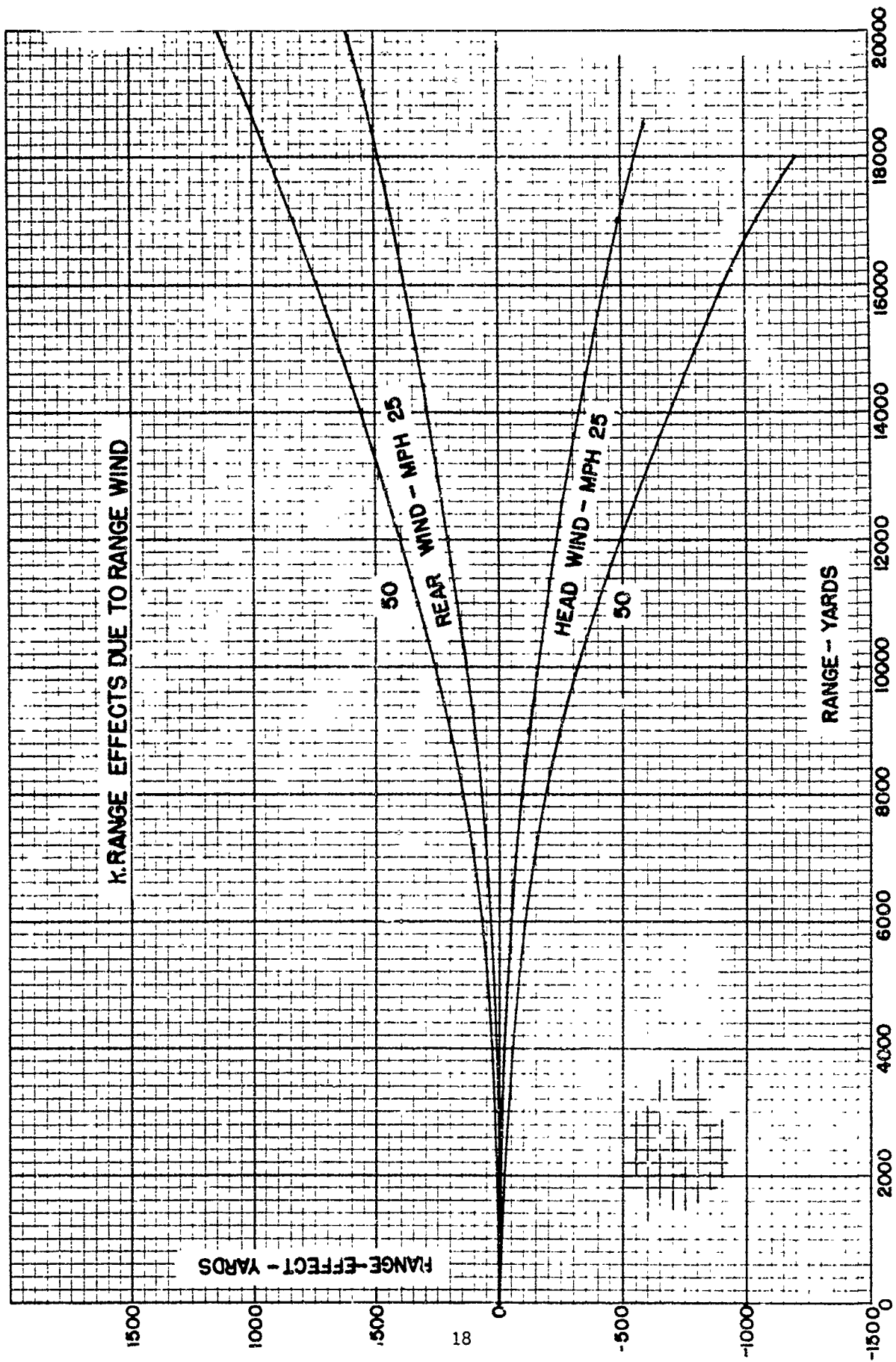

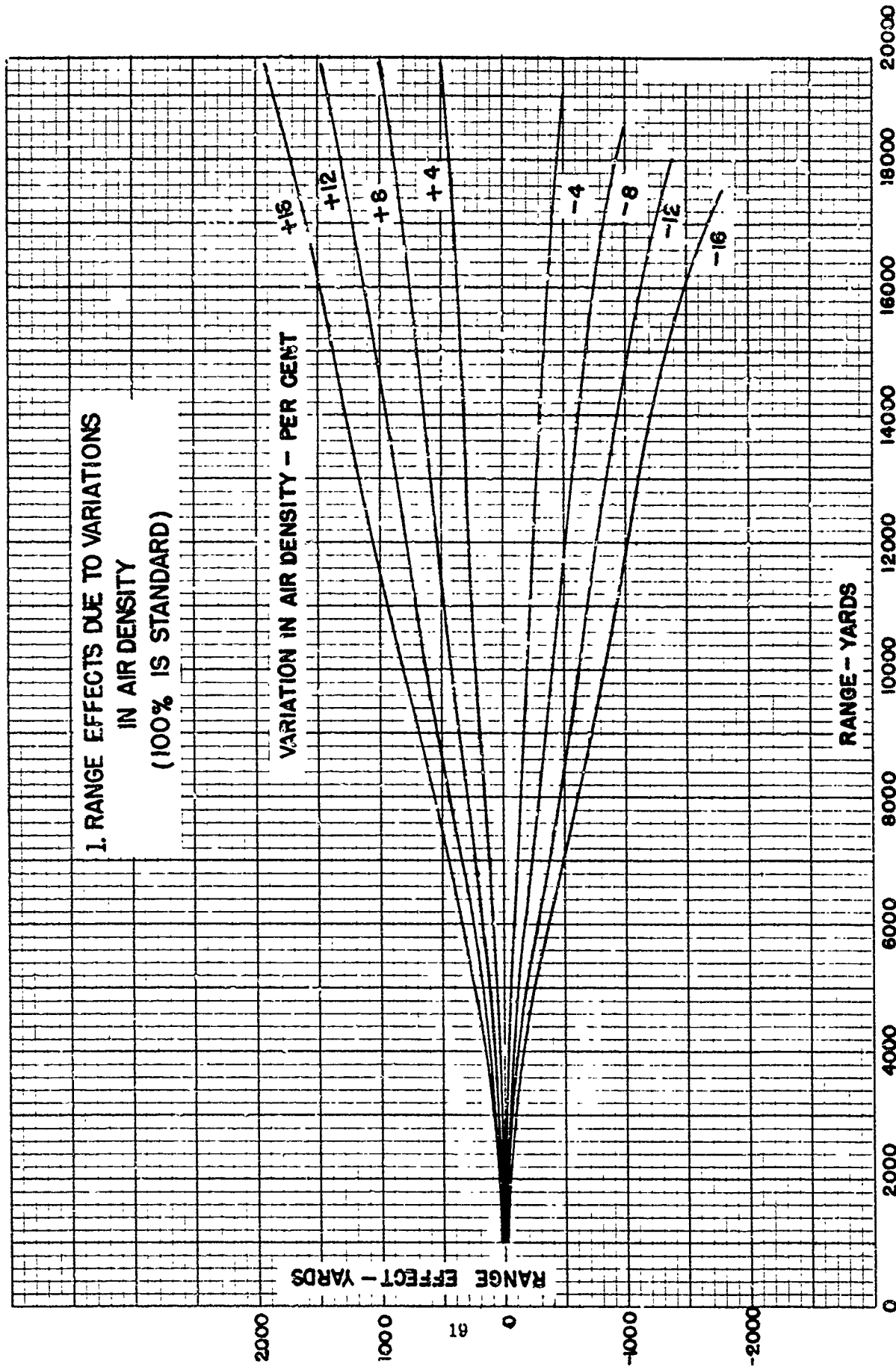

SECTION V
EFFECT DATA

	<u>Paragraph</u>
Fragmentation - - - - -	10
Effectiveness - - - - -	11
Ricochet data - - - - -	12
Penetration - - - - -	13

10. Fragmentation. The data on fragmentation of the 90-mm HE Shell M71 were taken from TM9-1907, "Ballistic Data, Performance of Ammunition" (Sep 1944) and Vol. III of "Terminal Ballistic Data" (Sep 1945). The initial fragment velocity is 2900 fps.

a. Casualties.

TABLE 46
CASUALTIES

Distance from burst (ft)	Total number of effective fragments	Average number of effective frag- ments per sq ft	For the lightest effective fragment	
			Weight (oz)	Velocity (fps)
r	N	E	m	v
20	668	0.133	0.015	1990
30	594	0.0525	0.022	1640
40	547	0.0272	0.028	1460
60	474	0.0105	0.041	1210
80	427	0.0053	0.055	1040
100	398	0.0032	0.067	943
150	347	0.0012	0.094	796
200	319	0.0006	0.120	705
300	264	0.0002	0.180	575
500	208	0.0001	0.340	418

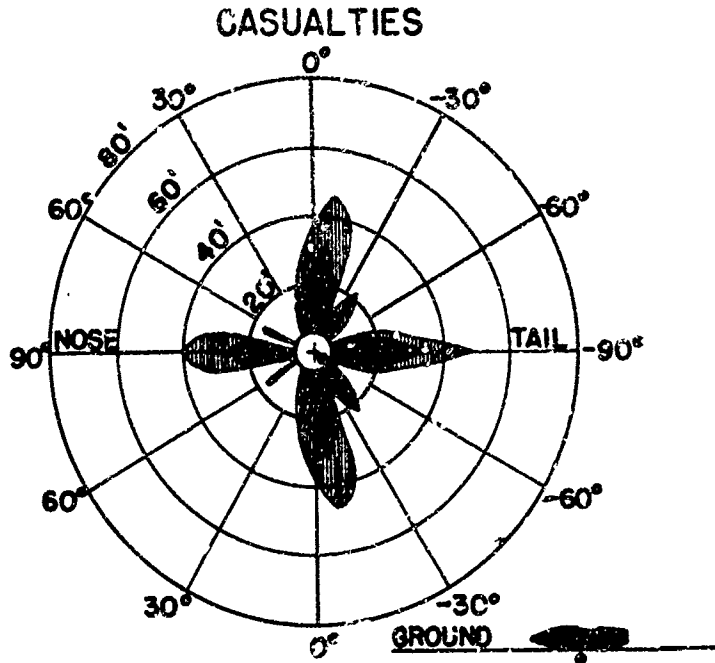

INCLINATION 0°
HEIGHT OF BURST 0 FT
REMAINING VELOCITY 0 FPS

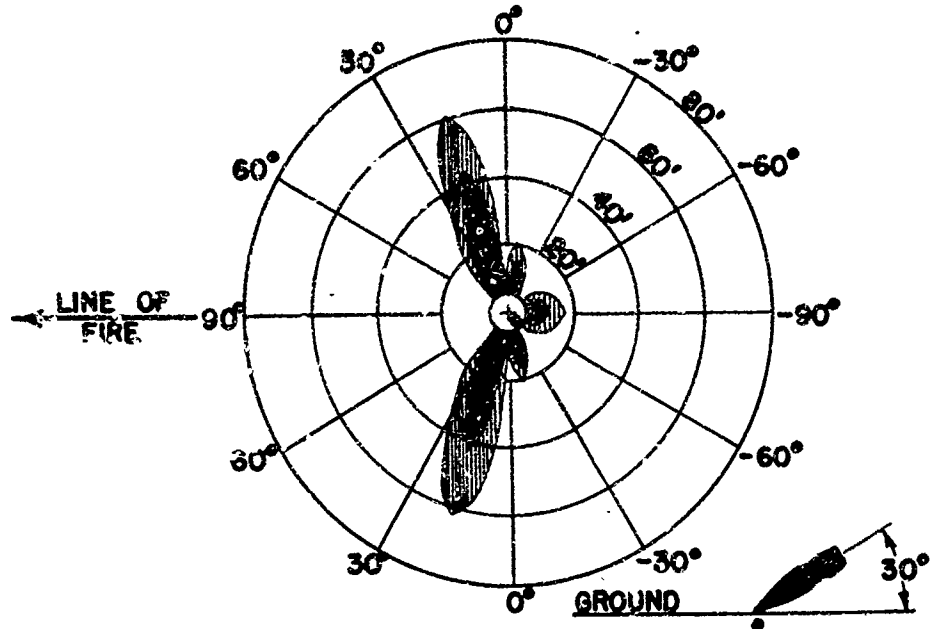



INCLINATION 30°
HEIGHT OF BURST 0 FT
REMAINING VELOCITY 947 FPS

- AT LEAST 1 HIT PER 4 SQ FT
- AT LEAST 1 HIT PER 10 SQ FT

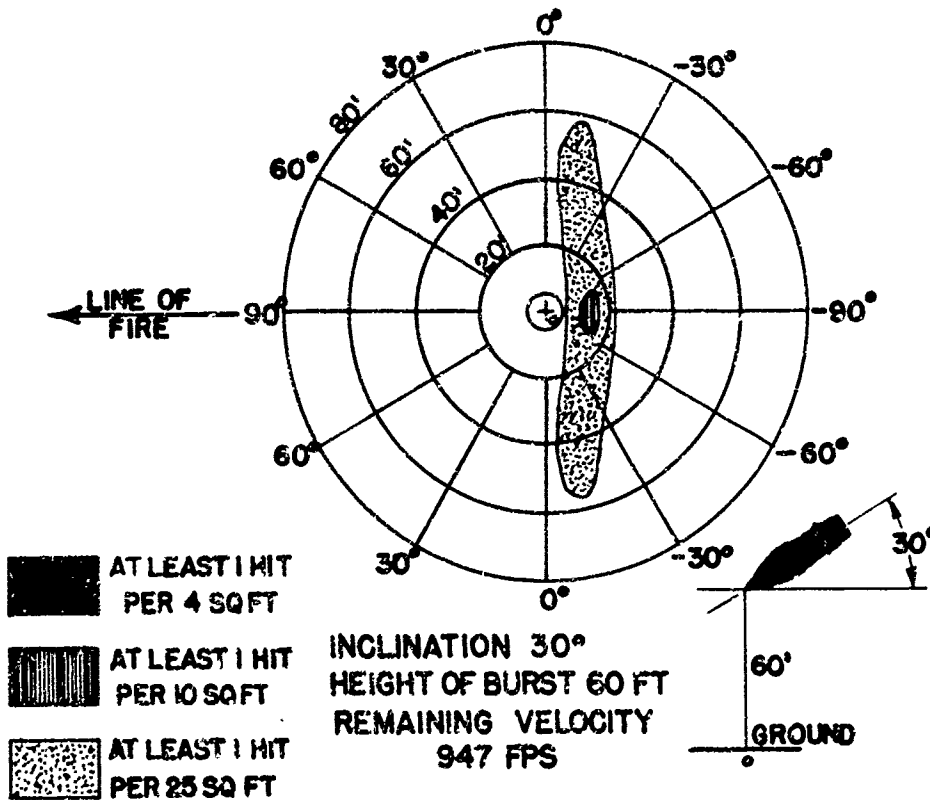
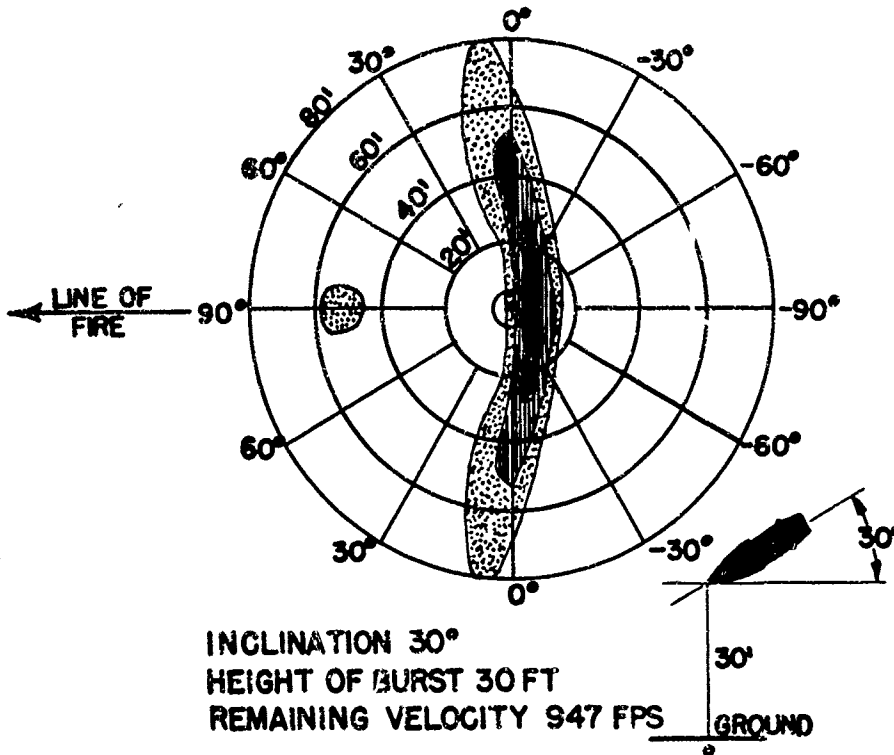
CASUALTIES



-  AT LEAST 1 HIT PER 4 SQ FT
-  AT LEAST 1 HIT PER 10 SQ FT
-  AT LEAST 1 HIT PER 25 SQ FT

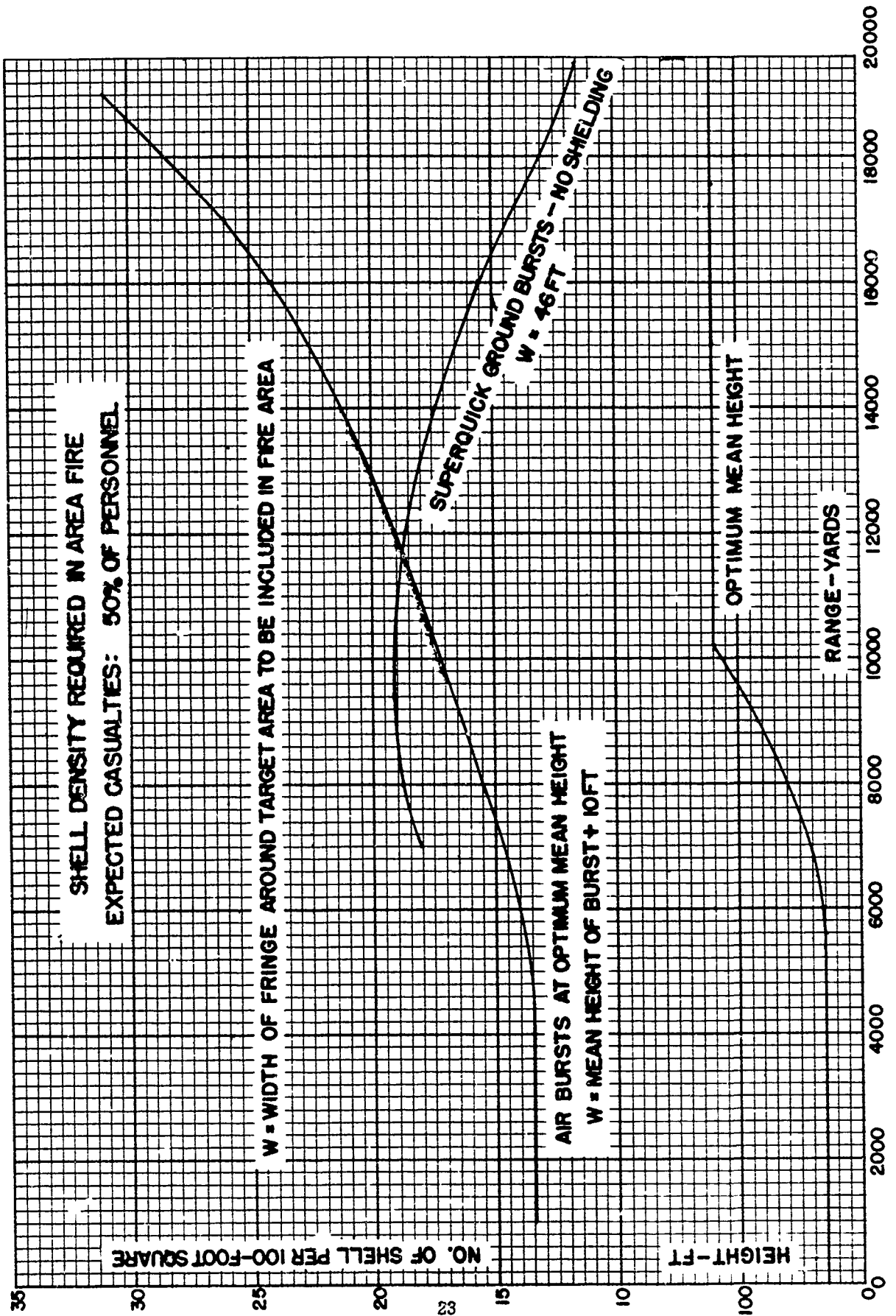

b. Perforation of 1/8-inch Mild Steel.

TABLE 47
PERFORATION OF 1/8 IN. MILD STEEL

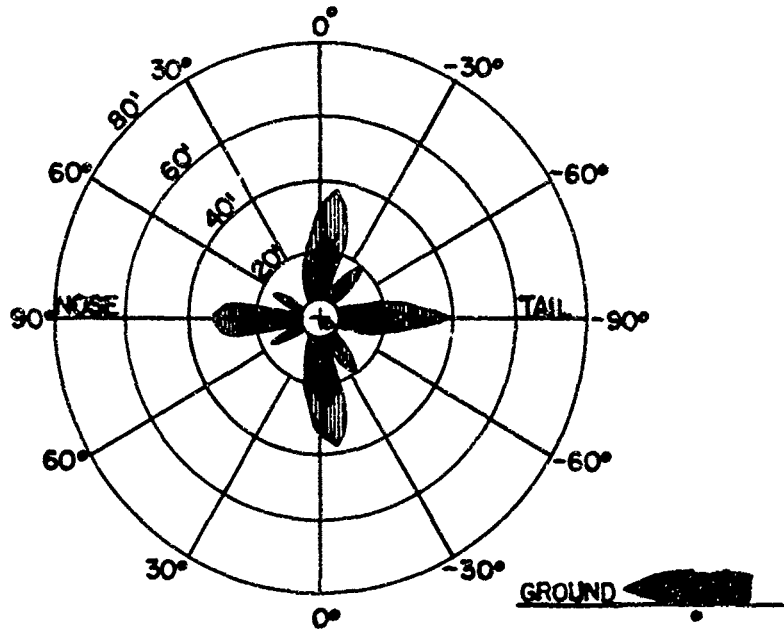

Distance from burst (ft)	Total number of effective fragments	Average number of effective frag- ments per sq ft	For the lightest effective fragment	
			Weight (oz)	Velocity (fps)
r	N	B	m	v
20	424	0.0844	0.057	2,270
30	380	0.0336	0.075	2,080
40	345	0.0172	0.095	1,920
60	288	0.0064	0.147	1,710
80	243	0.0030	0.210	1,500
100	222	0.0018	0.287	1,370
120	203	0.0011	0.377	1,260
150	163	0.0006	0.519	1,150
200	113	0.0002	0.772	1,040
275	59	0.0001	1.16	935

PERFORATION 1/8-INCH MILD STEEL

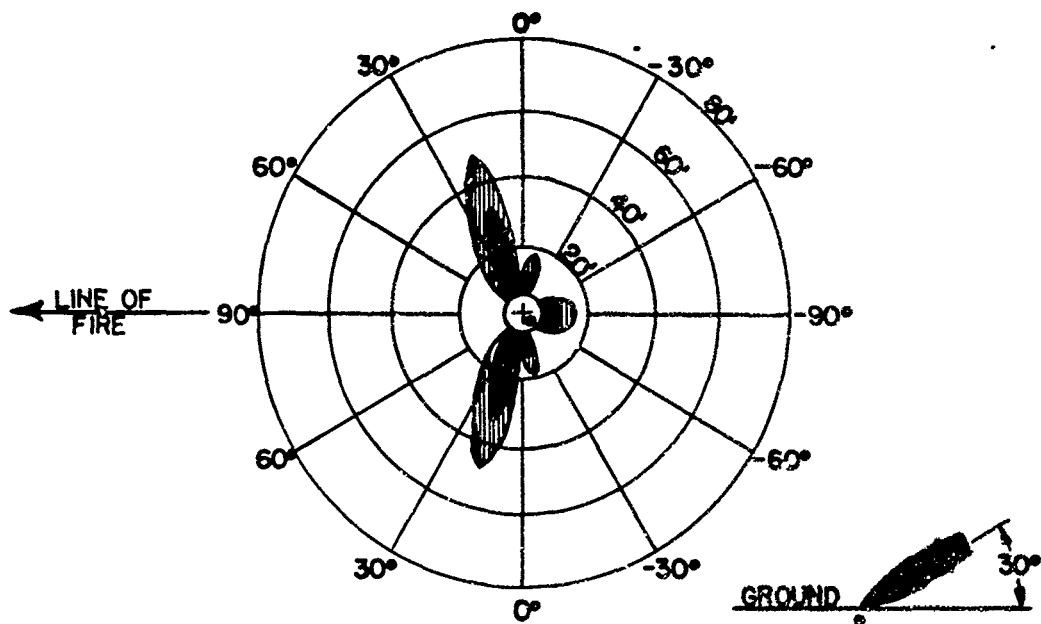

INCLINATION 0°
HEIGHT OF BURST OF T
REMAINING VELOCITY OF TS



-  AT LEAST 1 HIT
PER 4 SQ FT
-  AT LEAST 1 HIT
PER 10 SQ FT

INCLINATION 30°
HEIGHT OF BURST OF T
REMAINING VELOCITY 947 FPS

PERFORATION OF 1/8-INCH MILD STEEL

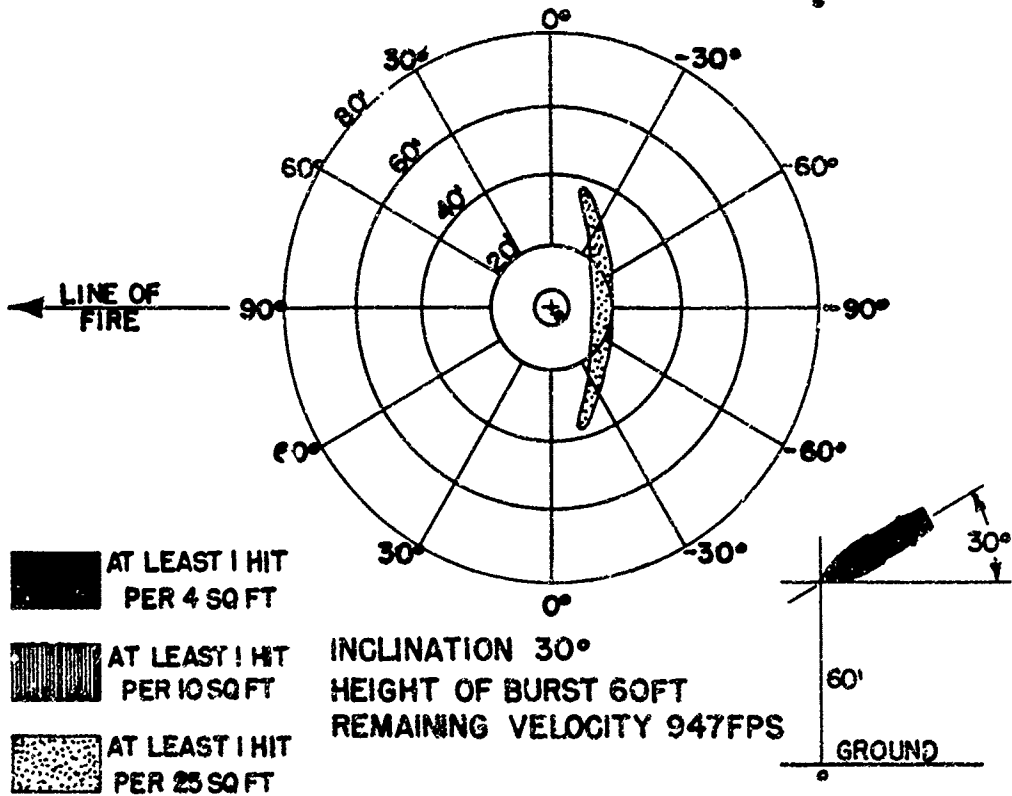
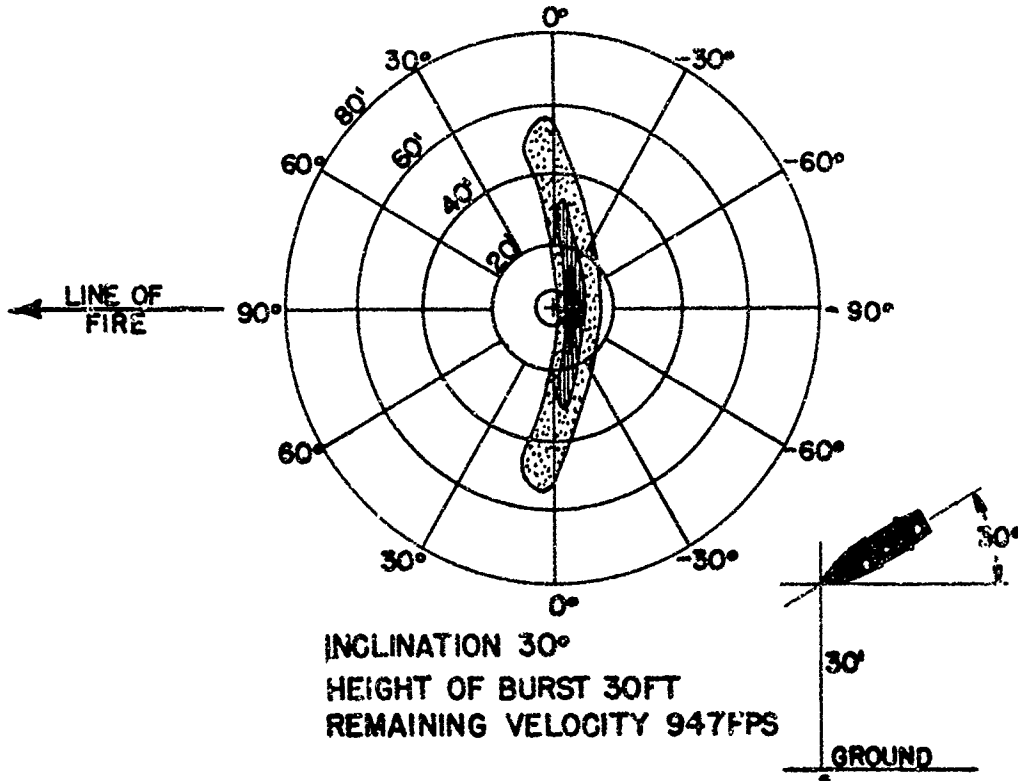

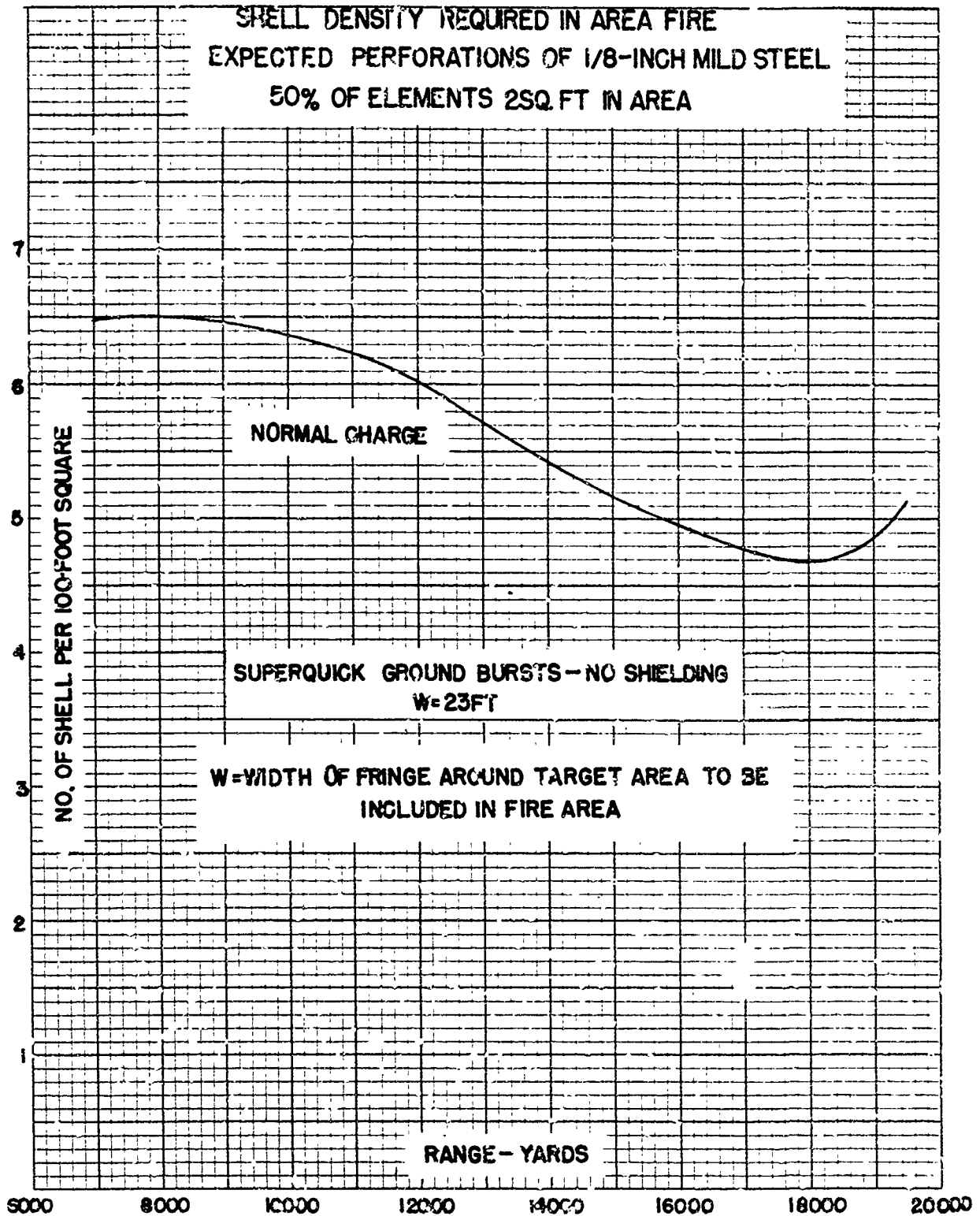

11. Effectiveness. The following data were taken from Vol. III of "Terminal Ballistic Data". They pertain to the 90-mm HE Shell M71 with an MT, PD or TSQ Fuze, fired at a muzzle velocity of 2700 fps.

NUMBER OF ROUNDS REQUIRED AGAINST ENEMY ARTILLERY FOR 90%
PROBABILITY OF AT LEAST ONE EFFECTIVE HIT IN AIMED FIRE

Range yd	Type of Fire		
	Impact	Time	Time and impact
2,000	3	260	7
5,000	42	380	68
10,000	770	1400	730

12. Ricochet Data. The following data were taken from Vol. III of "Terminal Ballistic Data". They pertain to the 90-mm HE Shell M71 with the PD Fuze M48 set for 0.05 sec delay, fired at a muzzle velocity of 2700 fps (the PD Fuzes M48A1, M48A2 and M51A4 have 0.15 sec delay).

TABLE 76

Range yd	Angle of Fall mils	Angle of Recovery mils	Impact to Burst yd	Height of Burst ft	PE in
					Height of Burst ft
1,000	7	20	41	2	0
2,000	17	30	36	3	1
3,000	30	50	32	5	1
4,000	47	75	28	6	1
5,000	69	105	23	7	1
6,000	98	140	19	8	2
7,000	136	180	15	8	2
8,000	187	230	12	8	2
9,000	249	270	9	8	2
10,000	314	300	7	6	2

13. Penetration. The data on penetration of concrete by the HE Shell M71 with the CP Fuze M78, fired at a muzzle velocity of 2700 fps, were taken from TM 9-1907, "Ballistic Data, Performance of Ammunition". The data on penetration into medium earth and logs by the HE Shell M71 with any DP or CP Fuze, fired at a muzzle velocity of 2700 fps, were taken from Vol. III of "Terminal Ballistic Data".

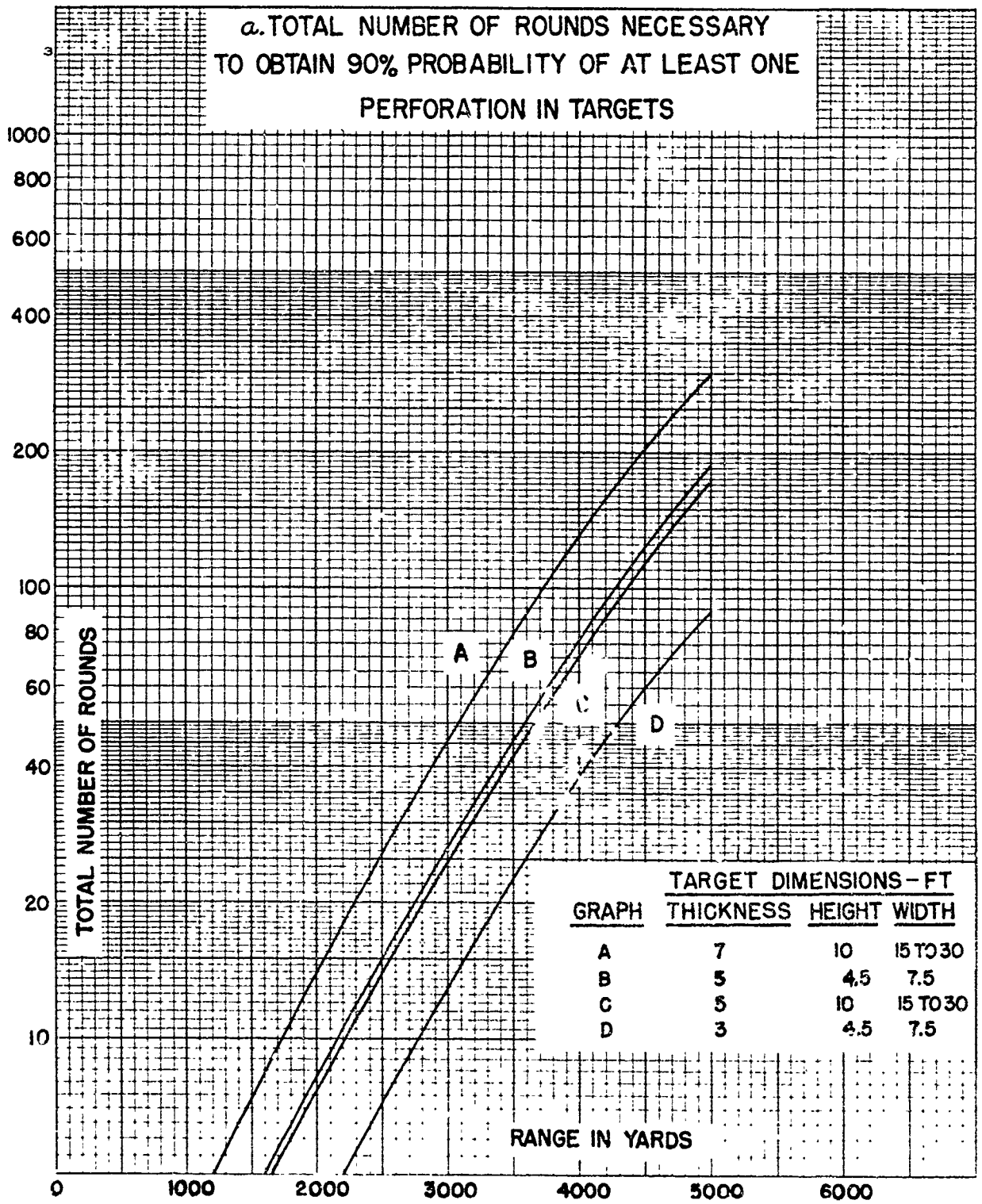

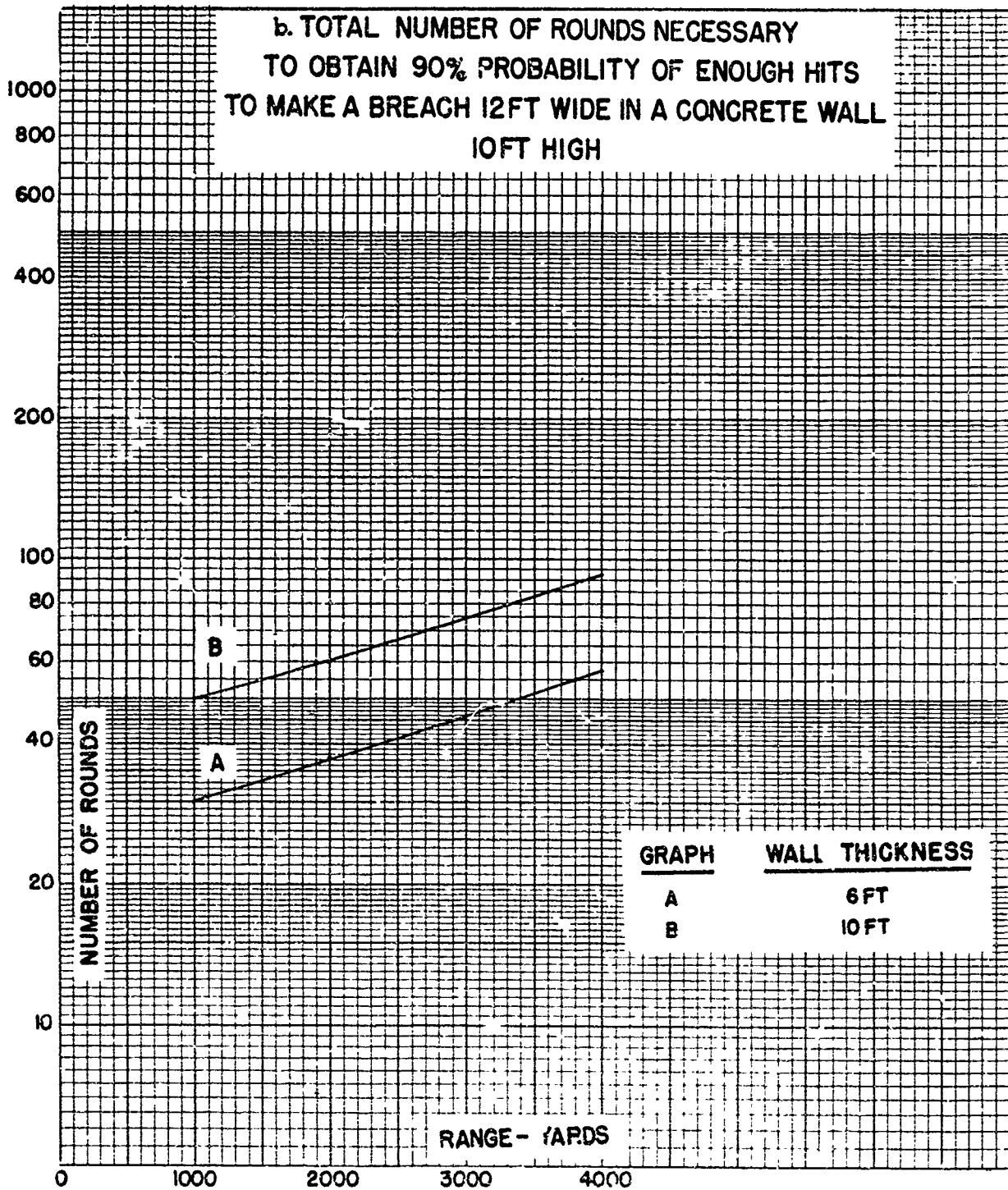

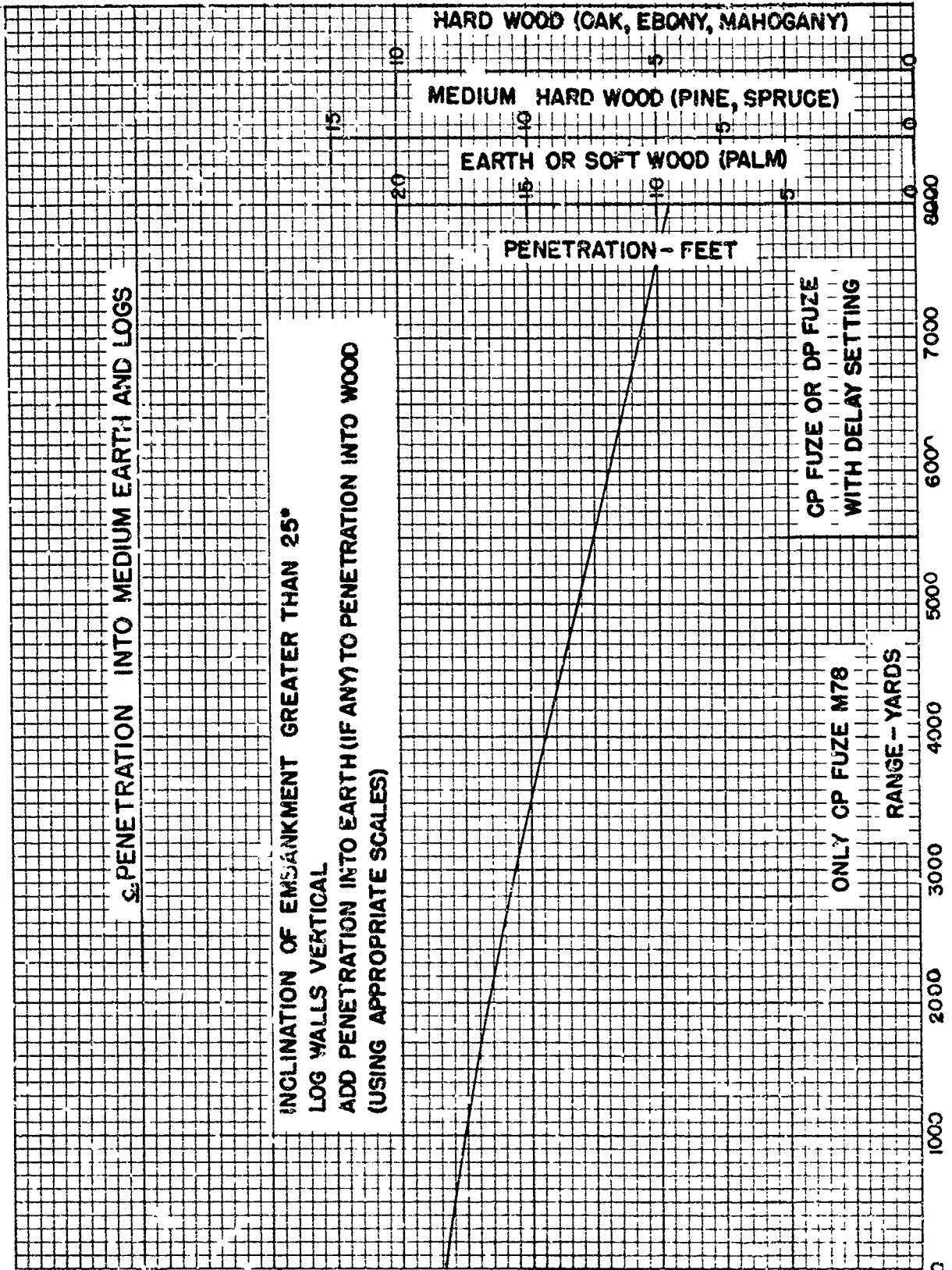

Ballistic Research Laboratories
Handbook of Ballistic and
Engineering Data for Ammunition,
No. 90-1-77

Ballistic Research Lab.
Aberdeen Proving Ground,
Maryland.
10 February 1949

BALLISTIC AND ENGINEERING DATA
for
Shot, AP, 90-mm, M77
with Tracer

<u>Section</u>		<u>Paragraph</u>
I	General -----	1
II	Description -----	2 - 4
III	Interior ballistic data -----	5
IV	Exterior ballistic data -----	6 - 7
V	Effect data -----	8

SECTION I
GENERAL

	<u>Paragraph</u>
Purpose - - - - -	1

1. **Purpose.** The purpose of this number of the handbook is to furnish a concise collection of information regarding the shape, dynamics, ballistics, and effects of the 90-mm Armor-piercing Shot M77 with Tracer. This information is collected from the drawings, reports, and firing tables pertaining to this ammunition.

SECTION II
DESCRIPTION

	<u>Paragraph</u>
Drawings - - - - -	2
Dimensions - - - - -	3
Physical characteristics - - - - -	4

ALL DIMENSIONS IN CALIBERS
1 CAL = 3.543"

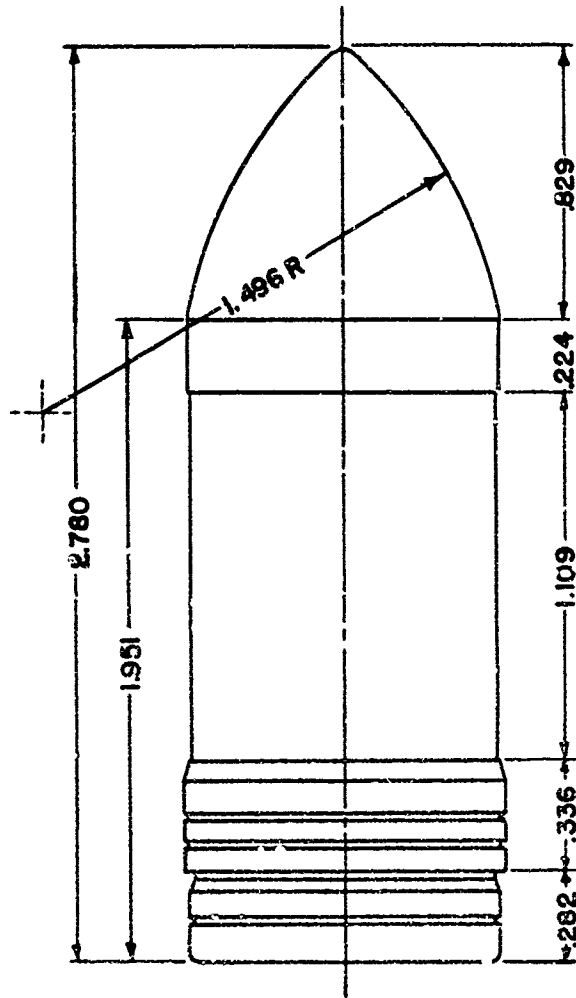

SHOT, AP, 90-MM, M77

2. Drawings.

Shot: Metal parts assembly and details 75-18-14

3. Dimensions.

Band: Distance from base	0.282 cal
Width	0.338 cal
Cylindrical body: Length	1.951 cal
Ogive: Length	0.829 cal
Radius of arc	1.496 cal
Shot: Total length	2.780 cal

4. Physical characteristics.

Weight (standard)	23.40 lb
Base to center of gravity*	1.22 cal
Axial moment of inertia*	34.6 lb.in ²
Transverse moment of inertia*	152 lb.in ²

*Estimated on the basis of measurements of the 37-mm AP Shot M80.

**SECTION III
INTERIOR BALLISTIC DATA**

	<u>Paragraph</u>
Theoretical yaw in bore - - - - -	5

5. Theoretical yaw in bore.

Minimum	3.0 min
Maximum	5.5 min

SECTION IV
EXTERIOR BALLISTIC DATA

	<u>Paragraph</u>
Aerodynamic data - - - - -	6
Firing table data - - - - -	7

6. Aerodynamic data.

a. **Drag.** The form factor relative to Projectile Type 1, determined from resistance firings, is 1.19. The corresponding ballistic coefficient is 1.564 on the G_1 drag function. The drag coefficient is 0.256 at a velocity of 2700 fps.

b. **Stability.** No stability firings have been done with this projectile. The stability factor, estimated from that of the 37-mm Armor-piercing Shot M80 (Ballistic Research Laboratory Report 438), at a muzzle velocity of 2700 fps and a twist of rifling of one turn in 32 calibers, is 6.4.

7. Firing table data. FT 90-D-2 (Abridged).

Guns, 90-mm, M1, M1A1, M2, M3 and M26.
Twist of rifling: 1/32.
Muzzle velocity: 2700 fps.

This Shot was standardized by OCM item 17528; its designation was changed from Semi-armor-piercing to Armor-piercing by OCM item 17699.

- a. **Form factor** (Proj Type 1). $i_1 = 1.19$.
- b. **Ballistic coefficient** (Proj Type 1). $C_1 = 1.564$.

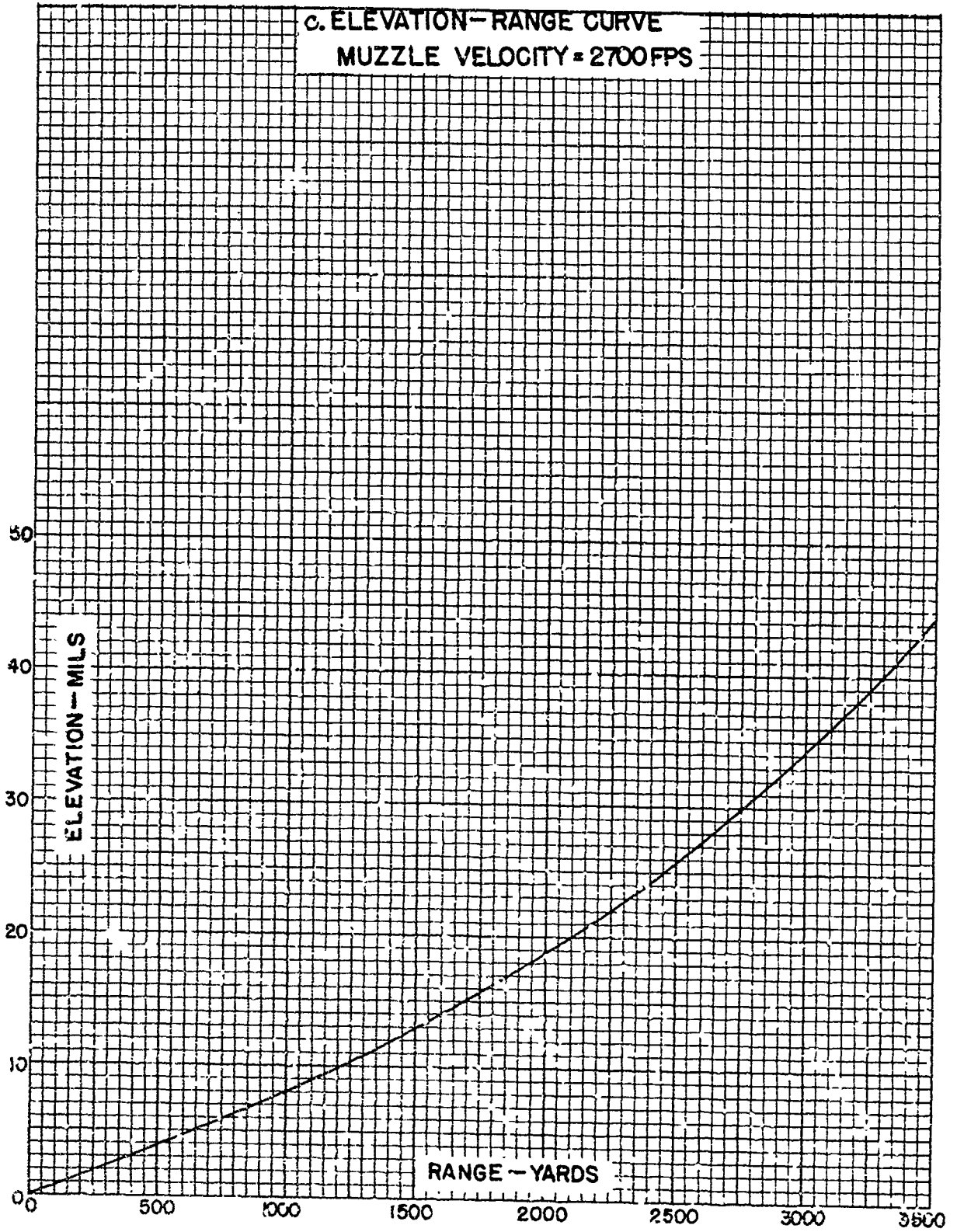

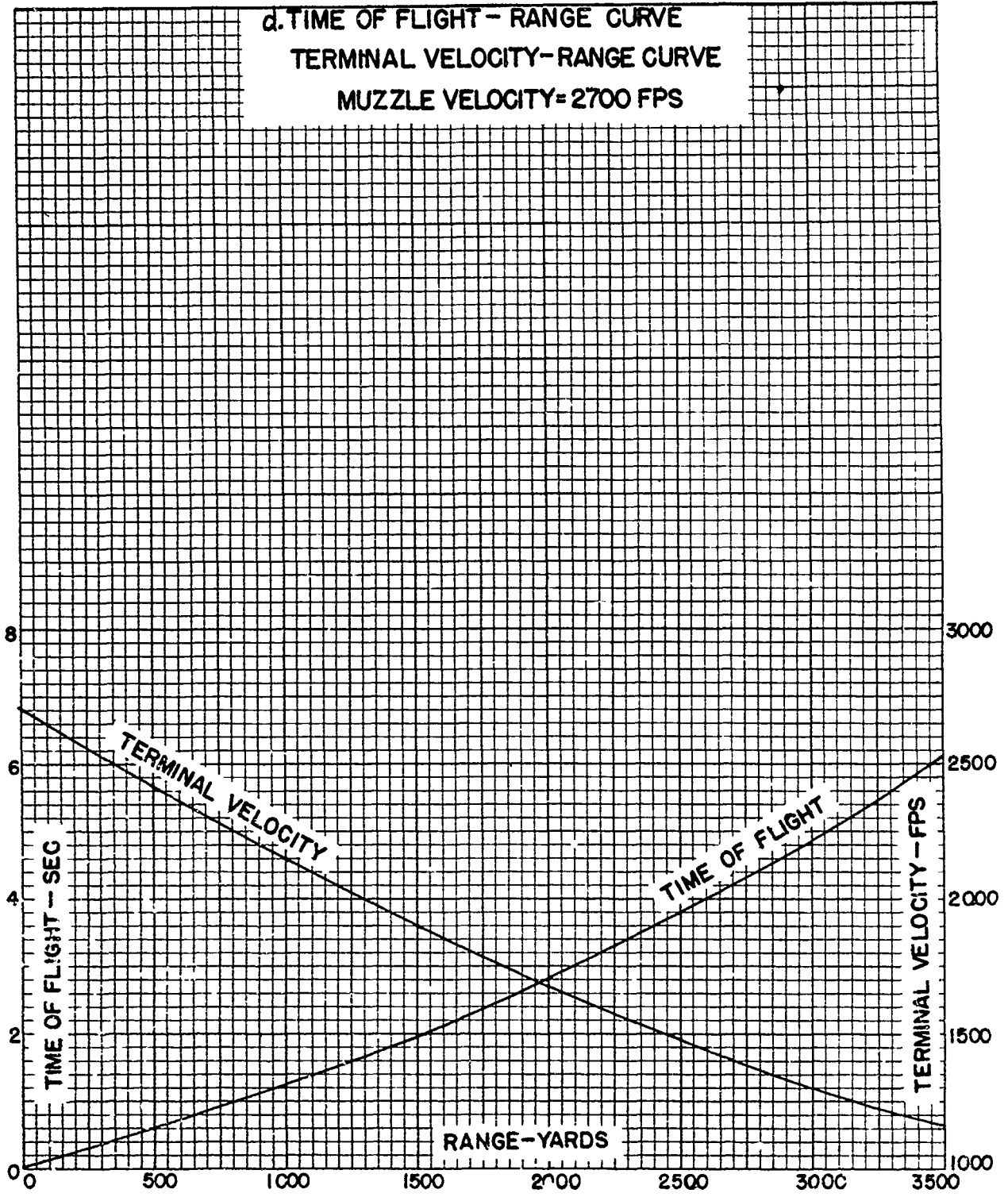

SECTION V
EFFECT DATA

Penetration - - - - - Paragraph
8

8. Penetration.

<u>Thickness</u> <u>inches</u>	<u>Homogeneous Plate</u>		<u>Ballistic Limit</u>		<u>Number</u> <u>in</u> <u>Average</u>
	<u>Brinnell</u> <u>Number</u>	<u>Obliquity</u> <u>degrees</u>	<u>Type</u>	<u>fps</u>	
3	270	0	Army	1166	2
4		0	Army	1679	2
4		0	Navy	1763	2

Ballistic Research Laboratories
Handbook of Ballistic and
Engineering Data for Ammunition,
No. 90-1-82

Ballistic Research Lab.
Aberdeen Proving Ground,
Maryland.
10 February 1949

BALLISTIC AND ENGINEERING DATA
for
Projectile, APC, 90-mm, M82
with
Fuze, BD, M68

<u>Section</u>		<u>Paragraph</u>
I	General -----	1
II	Description -----	2 - 4
III	Interior ballistic data -----	5
IV	Exterior ballistic data-----	6 - 7
V	Effect data -----	8

SECTION I
GENERAL

	<u>Paragraph</u>
Purpose - - - - -	1

1. **Purpose.** The purpose of this number of the handbook is to furnish a concise collection of information regarding the shape, dynamics, ballistics, and effects of the 90-mm Armor-piercing Capped Projectile M82 with the Base Detonating Fuze M68, which contains a tracer composition. This information is collected from the drawings, reports, firing tables, and technical manuals pertaining to this ammunition.

ALL DIMENSIONS IN CALIBERS
1 CAL = 3.543"

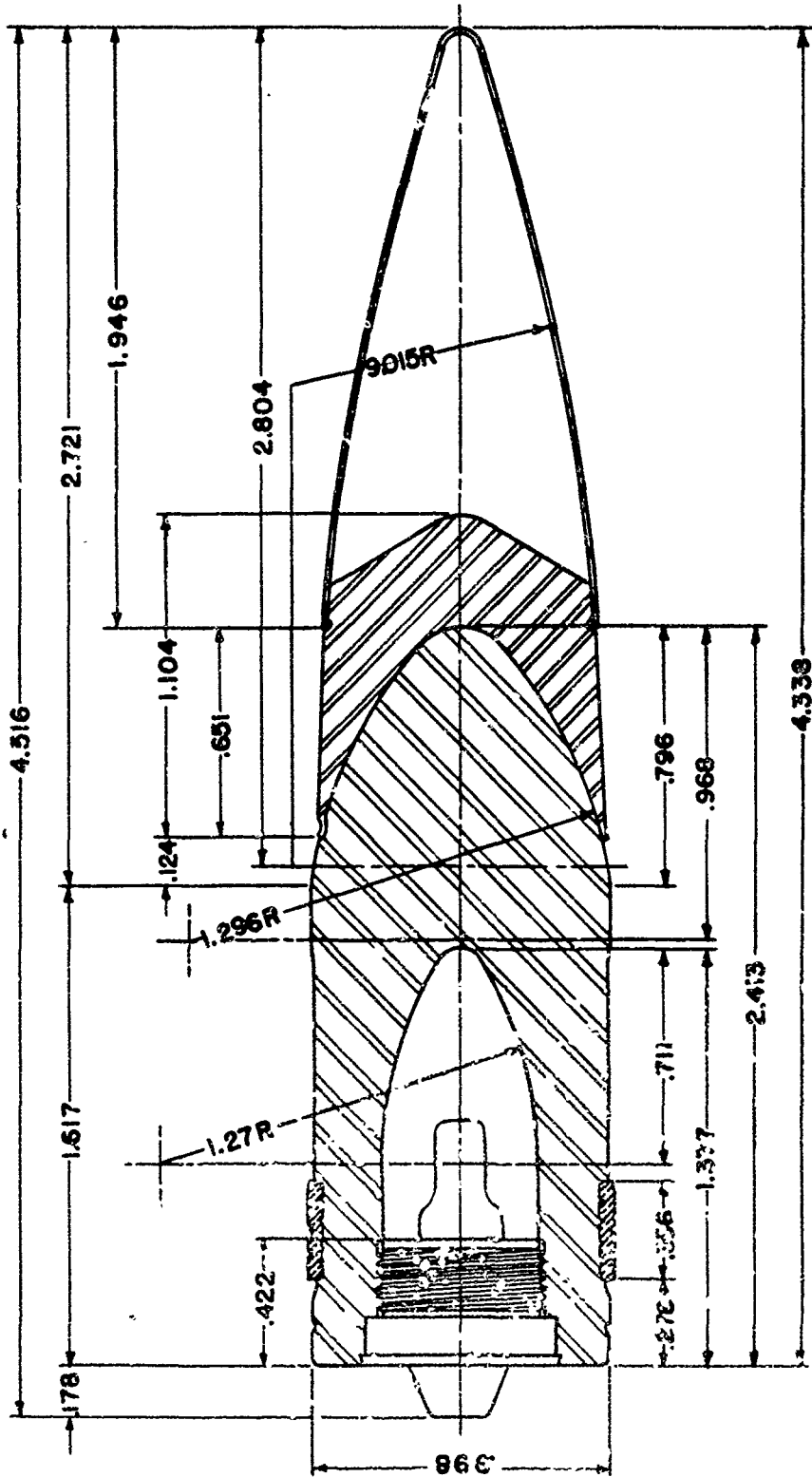

PROJECTILE, APC, 90-MM, M82
FUZE, BD, M68

SECTION II
DESCRIPTION

	<u>Paragraph</u>
Drawings - - - - -	2
Dimensions - - - - -	3
Physical characteristics - - - - -	4

2. Drawings.

Projectile: Metal parts assembly	75-18-46
Details	75-18-47
Details	75-18-51
Fuze: Assembly	73-2-181
Details	73-2-182

3. Dimensions.

Fuze: Length (outside)	0.178 cal
Band: Distance from base	0.278 cal
Width	0.356 cal
Body: Cylindrical length	1.017 cal
Ogival length (outside)	0.124 cal
Radius of ogival arc	1.206 cal
Cap: Length (outside)	0.651 cal
Windshield: Length	1.646 cal
Radius of ogival arc	9.015 cal
Length: Ogive	2.721 cal
Projectile without fuze	4.338 cal
Projectile and fuze	4.516 cal

4. Physical characteristics.

Weight (standard)	24.11 lb
Base to center of gravity*	1.145 cal
Axial moment of inertia*	35.9 lb.in ²
Transverse moment of inertia*	198 lb.in ²

*Estimated on the basis of measurements of the 3-Inch Armor-piercing Capped Projectile M62 with Base Detonating Fuze M66A1.

**SECTION III
INTERIOR BALLISTIC DATA**

	<u>Paragraph</u>
Theoretical yaw in bore - - - - -	5

5. Theoretical yaw in bore.

Minimum	4 min
Maximum	7 min

**SECTION IV
EXTERIOR BALLISTIC DATA**

	<u>Paragraph</u>
Aerodynamic data . - - - - -	6
Firing table data - - - - -	7

6. Aerodynamic data.

a. Drag. A form factor of 0.90 relative to the C_D drag function was determined from resistance firings at velocities from 2000 to 2660 fps. The corresponding ballistic coefficient is 2.134. The drag coefficient is 0.135 at 2000 fps and 0.108 at the standard muzzle velocity of 2670 fps.

b. Stability. No stability firings have been done with the 90-mm APC Projectile M82. The stability factor, estimated from that of the 3-inch Armor-piercing Capped Projectile M62 with Base Detonating Fuze M66A1 at a muzzle velocity of 2600 fps (Ballistic Research Laboratory Report 427), for a twist of rifling of one turn in 32 calibers is 1.58.

7. Firing table data. FT 90-F-1

Guns, 90-mm, M1, M1A1, M2, M3 and M26.

Twist of rifling: 1/32.

Muzzle velocity: 2670 fps and 2800 fps. Projective Weight: 24.06 lb

Standardization of the APC Projectile M82 with the BD Fuze M68 was recommended by OCM item 18386 and approved by OCM item 18496.

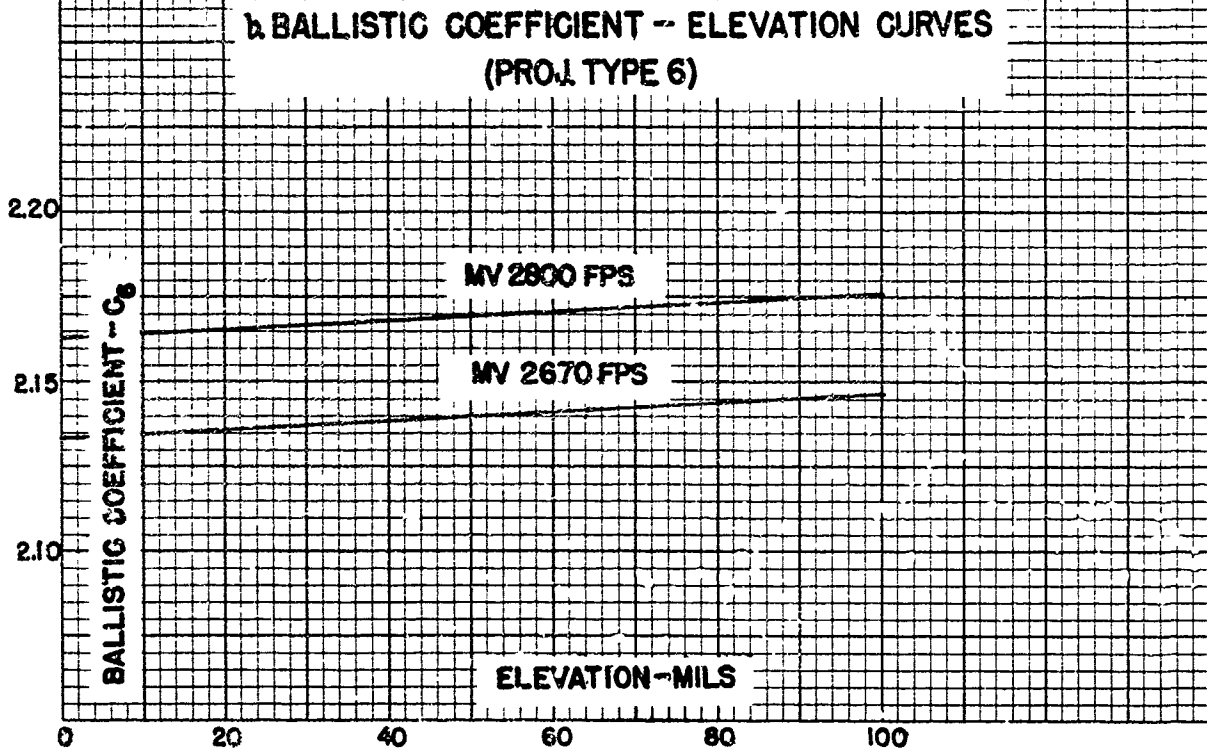
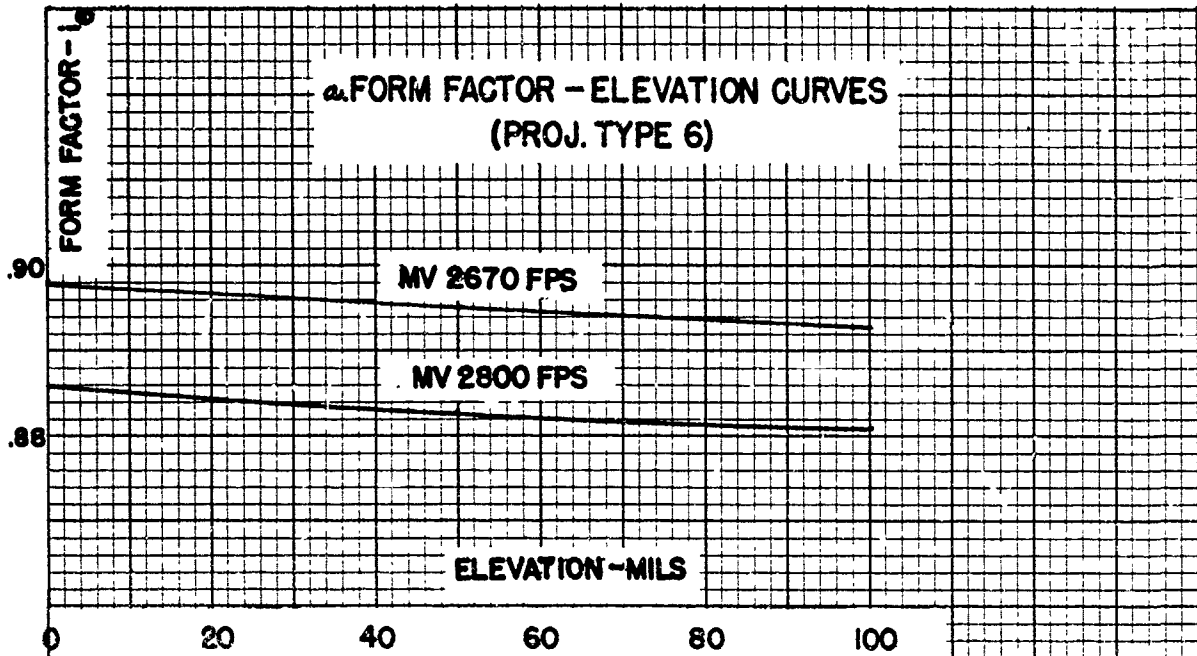

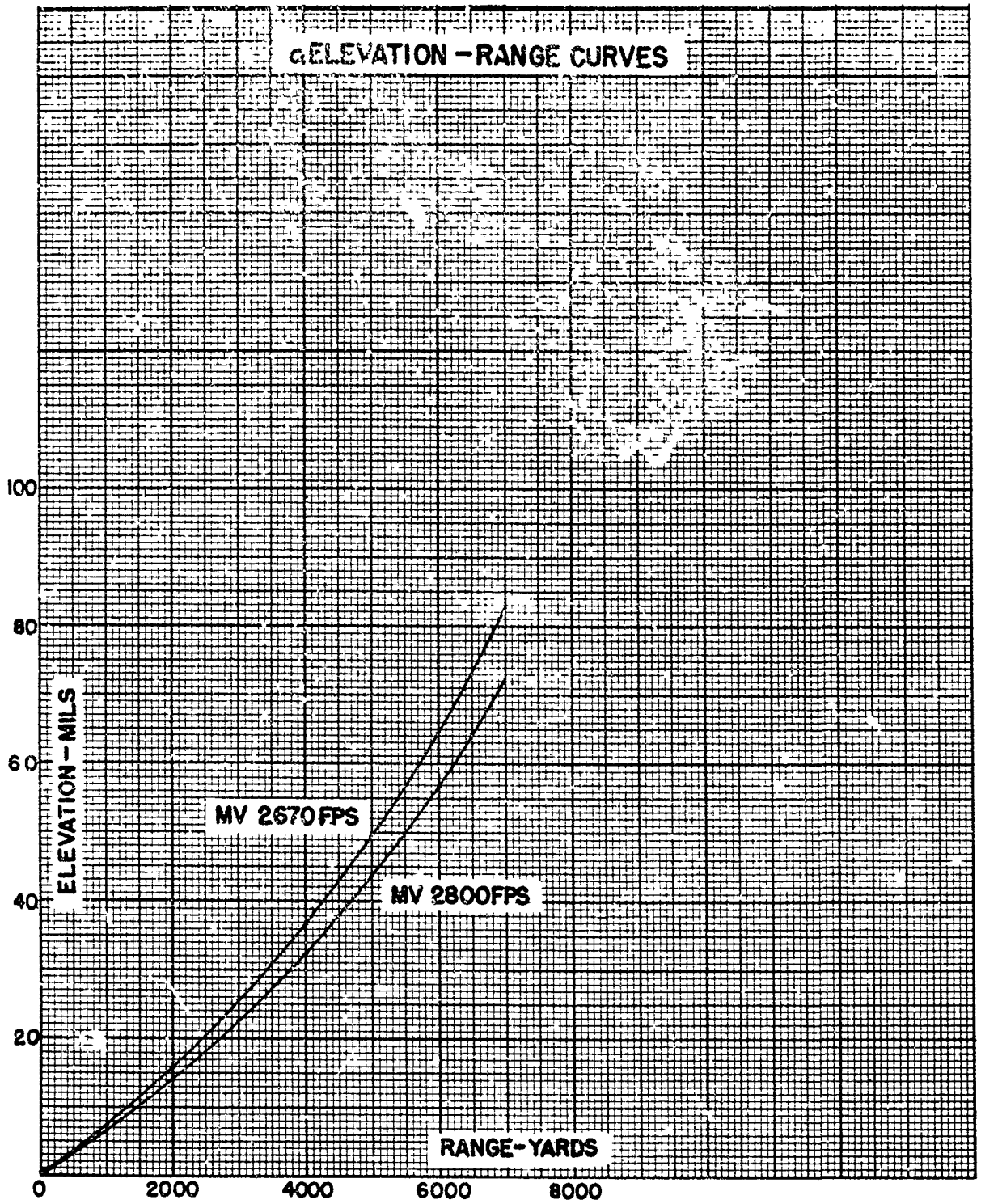

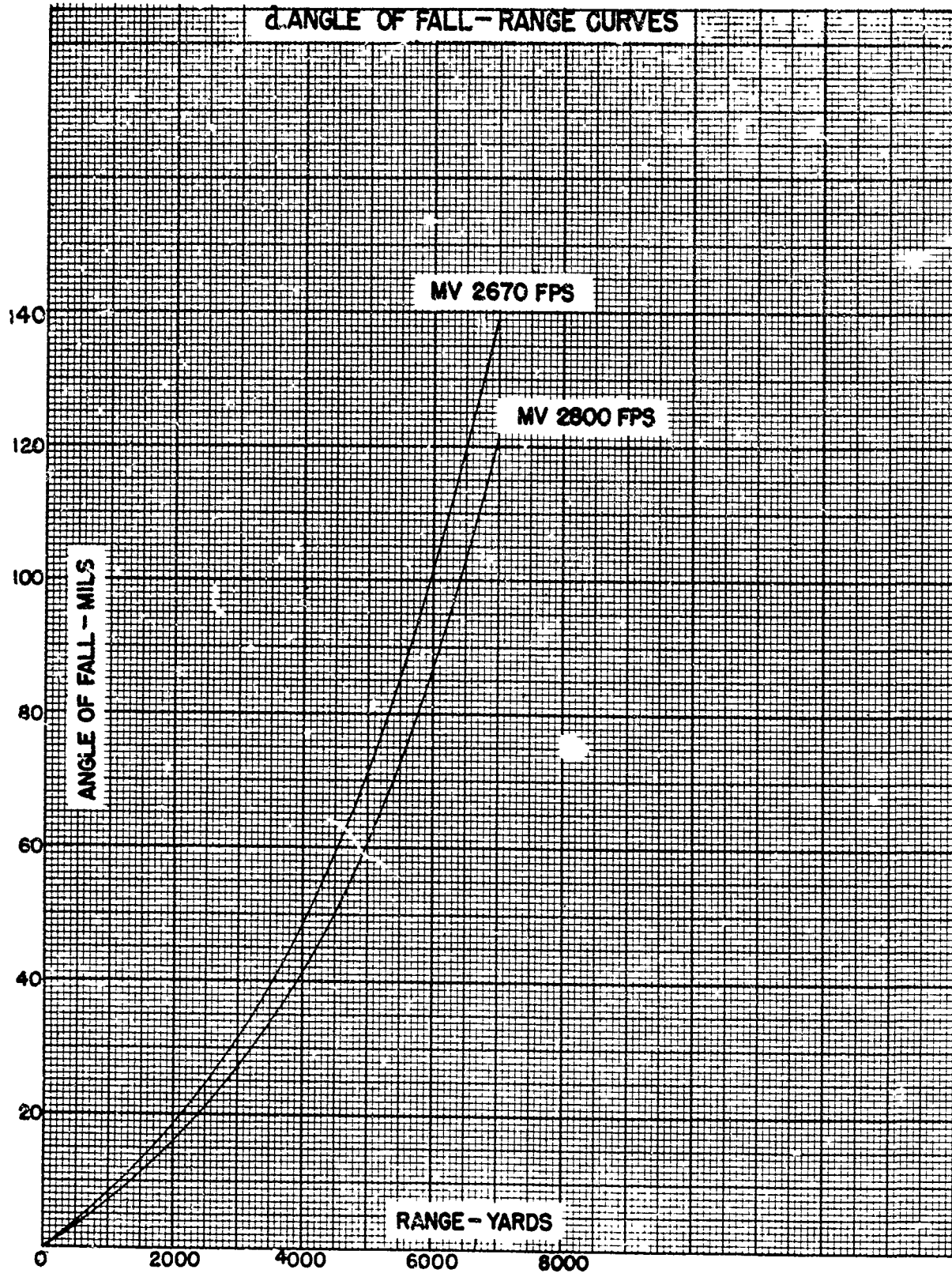

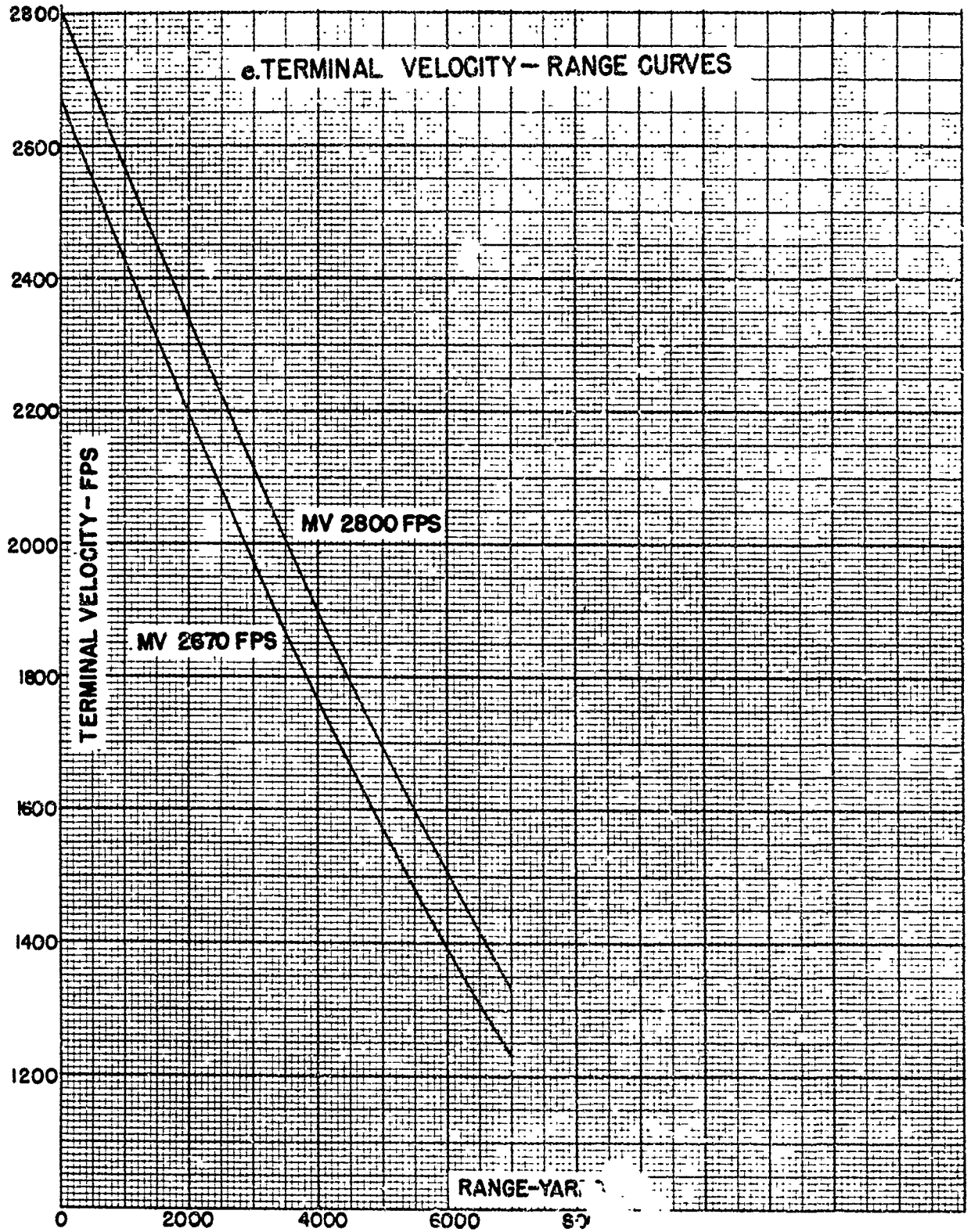

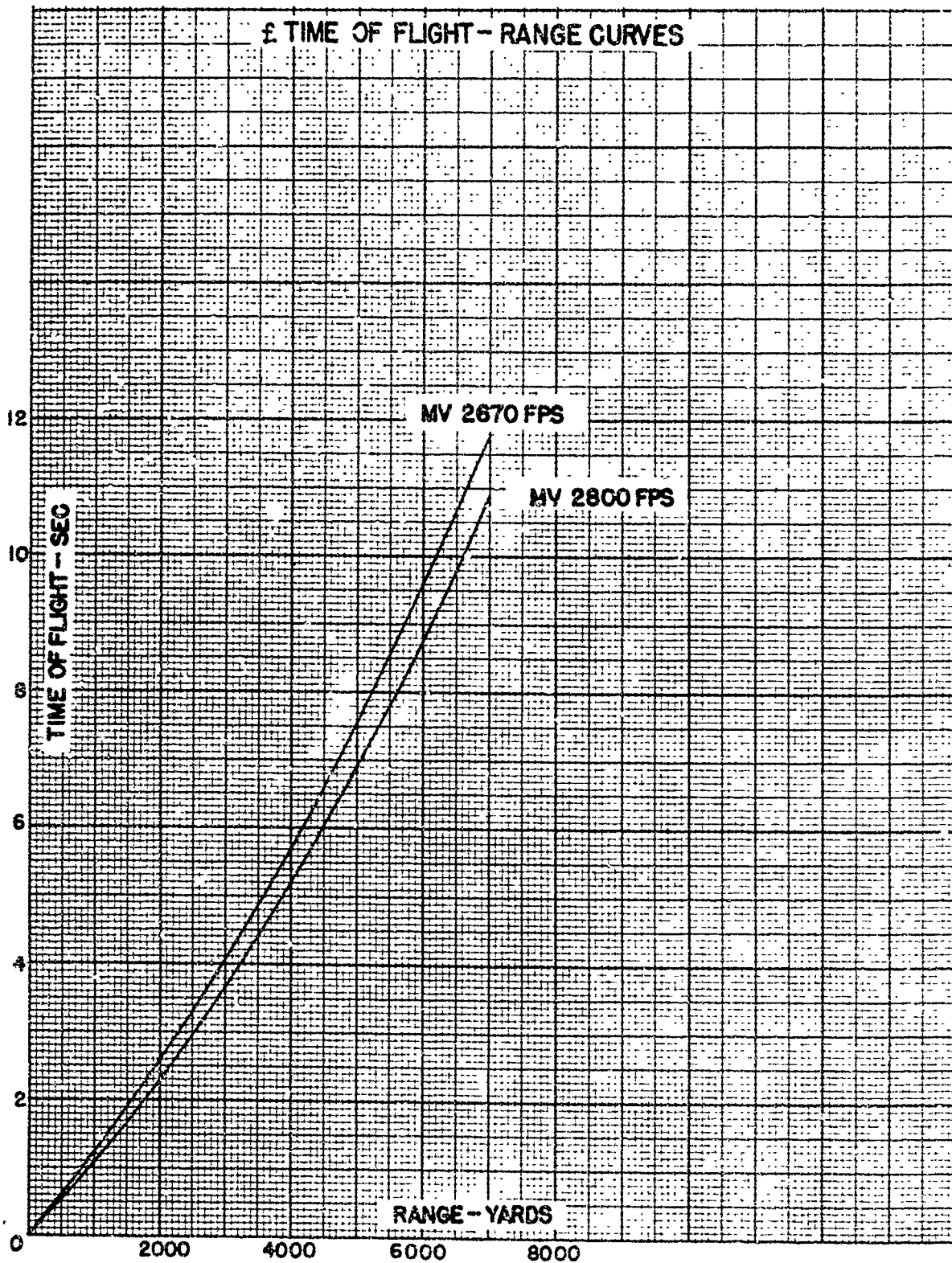

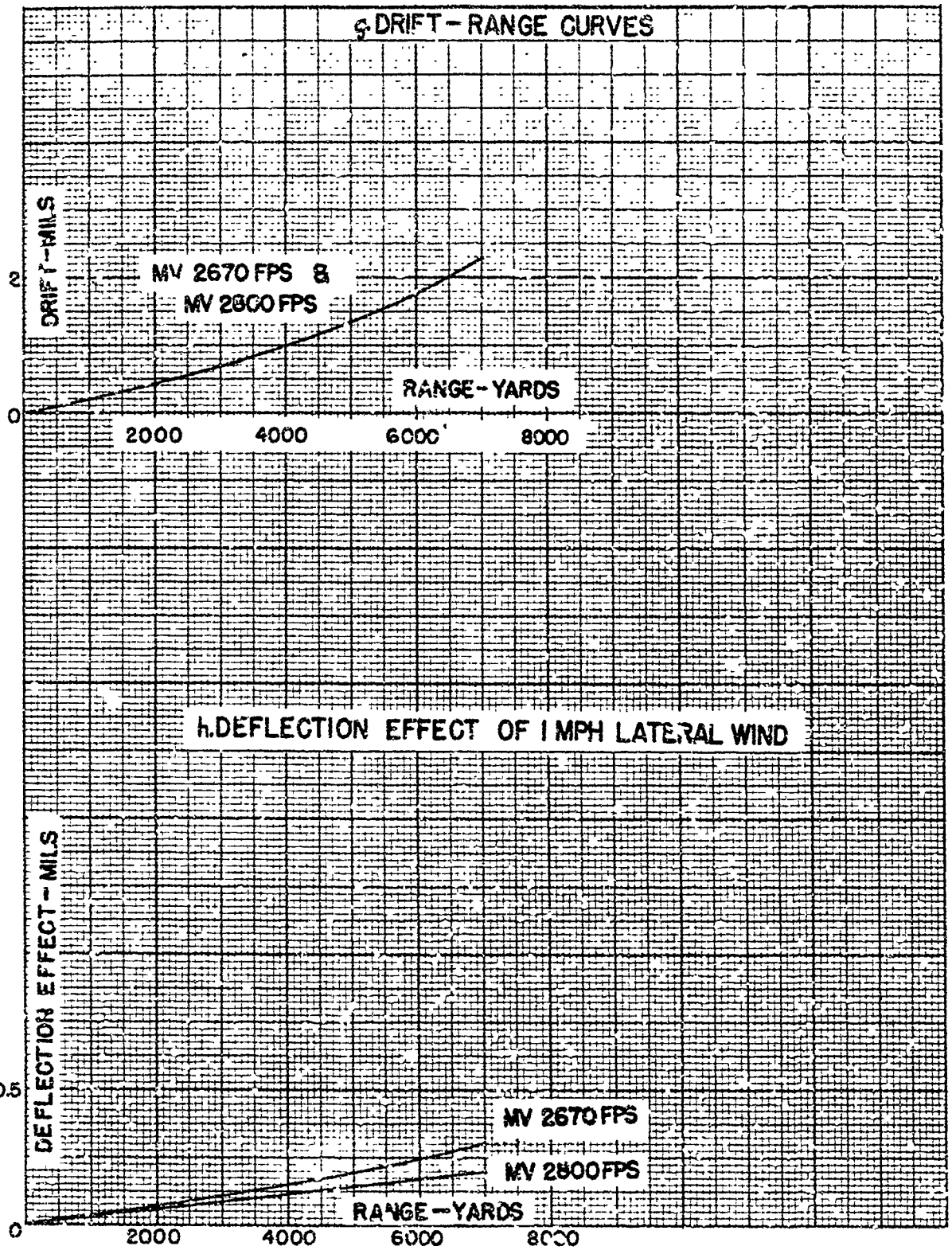

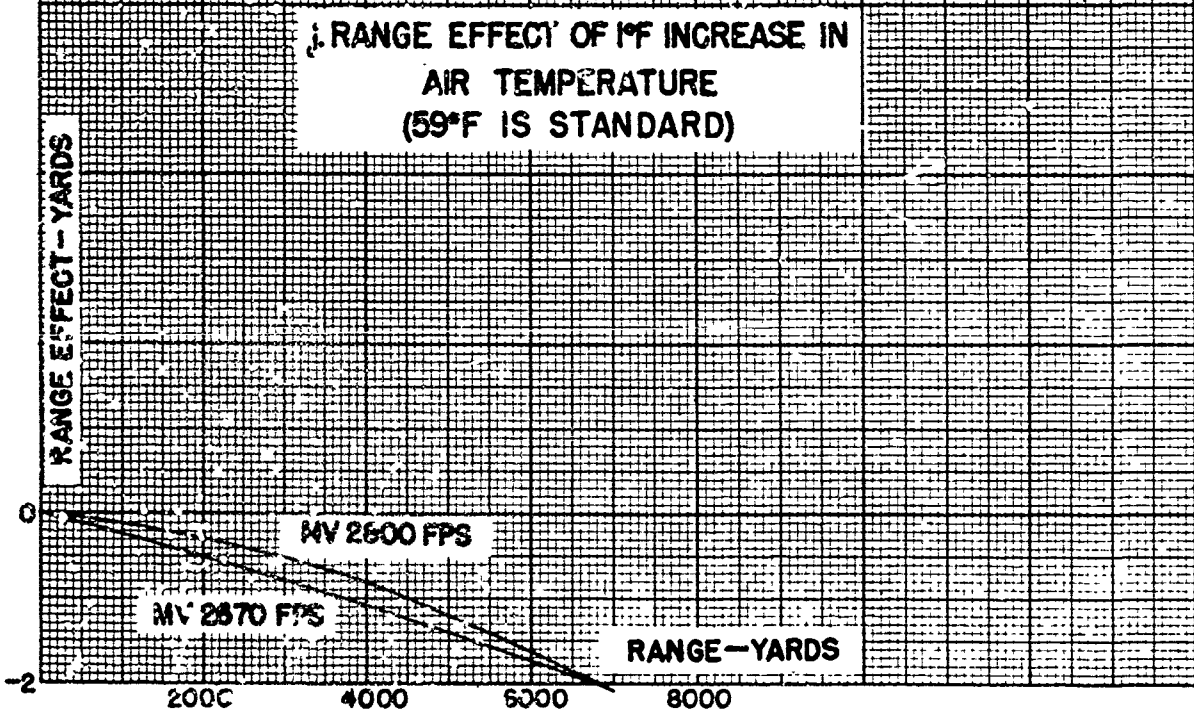
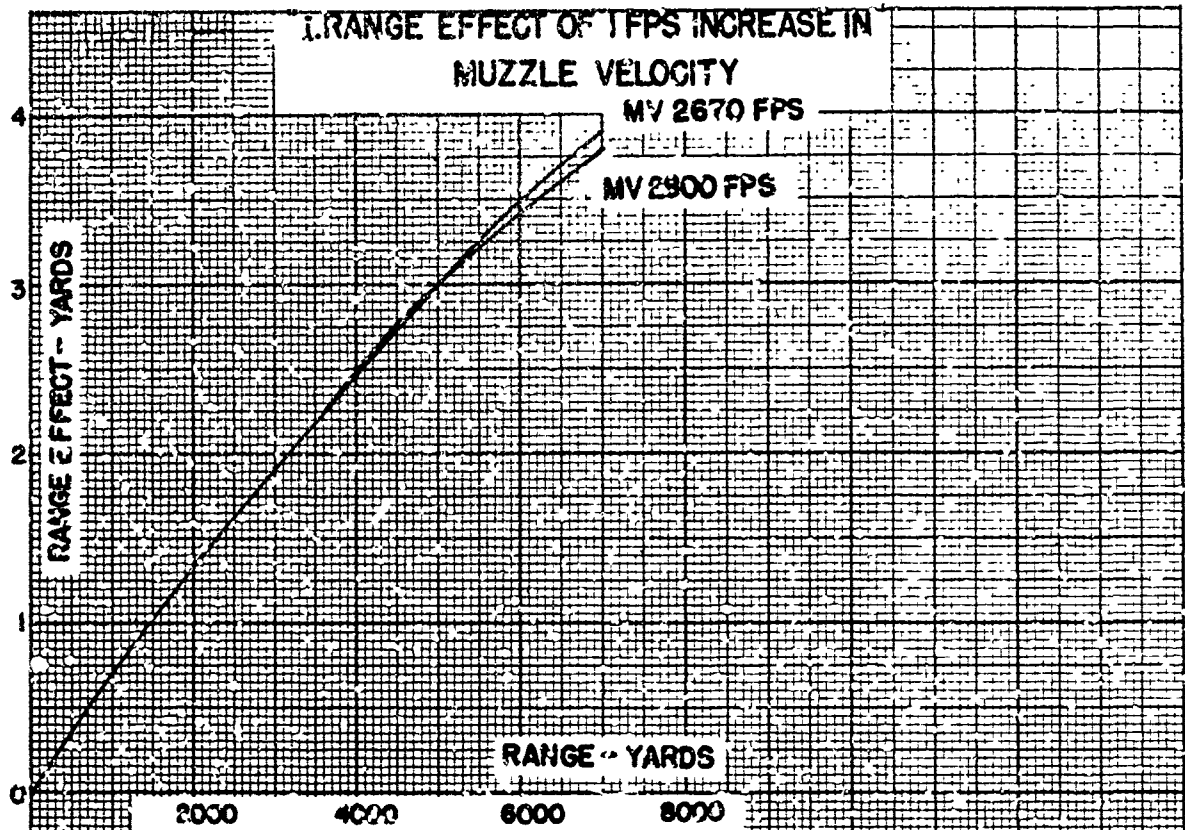

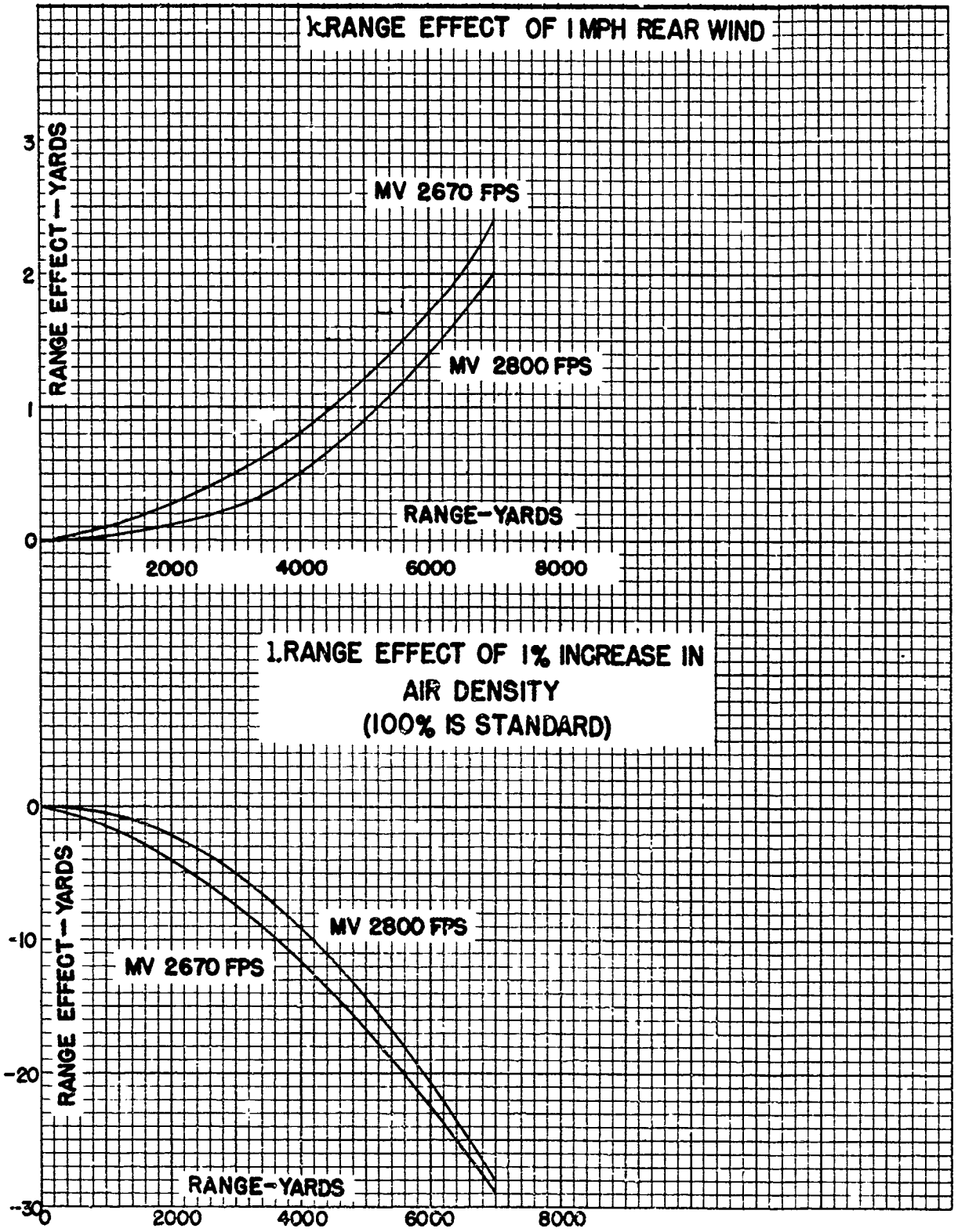

SECTION V
EFFECT DATA

Paragraph

Penetration - - - - - 8

8. Penetration.**a. Ballistic Limits of Armor Plate.**

Type	Plate		Ballistic Limit		Number in Average
	Thickness inches	Obliquity degrees	Type	fps	
Face					
Hardened	3	20	Navy	1770	2
Homogeneous	1.5	55	Navy	1775	1
	2.5	45	Navy	1981	1
	2.5	55	Navy	2504	1
	3	45	Navy	2519	2

b. Vulnerability of German Tanks (Panzerkampfwagen)

Muzzle Velocity: 2870 fps. These data were taken from TM9-1907, "Ballistic Data, Performance of Ammunition".

Maximum Vulnerable Range - yards

Tank Model		III		IV		VI	
Attack	Angle - deg	0	25	0	25	0	25
Frontal	Turret Sides	5000+	5000	5000+	5000+	4800	2680
	Turret Rear	----	----	----	----	4800	2680
	Turret Front	5000+	4660	5000+	4840	*	*
	Upper Hull Front	4300	3250	4300	3250	2900	1200
	Lower Hull Front	3600	2600	4080	3100	1880	*
Flank	Turret Sides	5000+	5000+	5000+	5000+	4800	2680
	Turret Rear	5000+	5000+	5000+	5000+	4800	2680
	Turret Front	5000+	4660	5000+	4840	*	*
	Upper Hull Sides	5000+	5000+	5000+	5000+	4800	2680
	Lower Hull Sides	5000+	5000+	5000+	5000+	5000+	4180
Rear	Turret Sides	5000+	5000+	5000+	5000+	4800	2680
	Turret Rear	5000+	5000+	5000+	5000+	4800	2680
	Turret Front	5000+	4660	5000+	4840	*	*
	Upper Hull Rear	5000+	4580	5000+	5000+	4320	2600
	Lower Hull Rear	5000+	4840	5000+	5000+	4320	2600

*Not vulnerable.

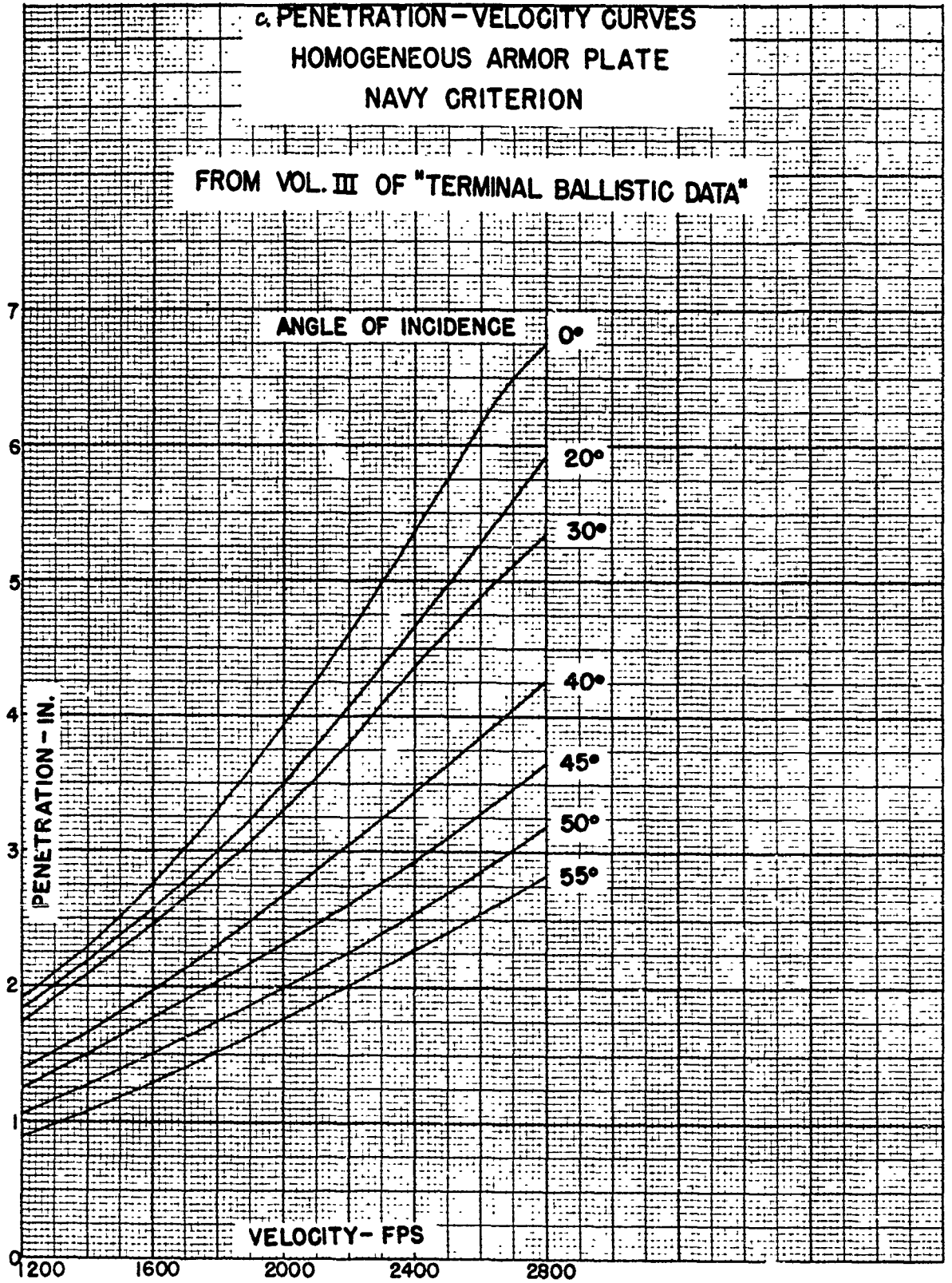

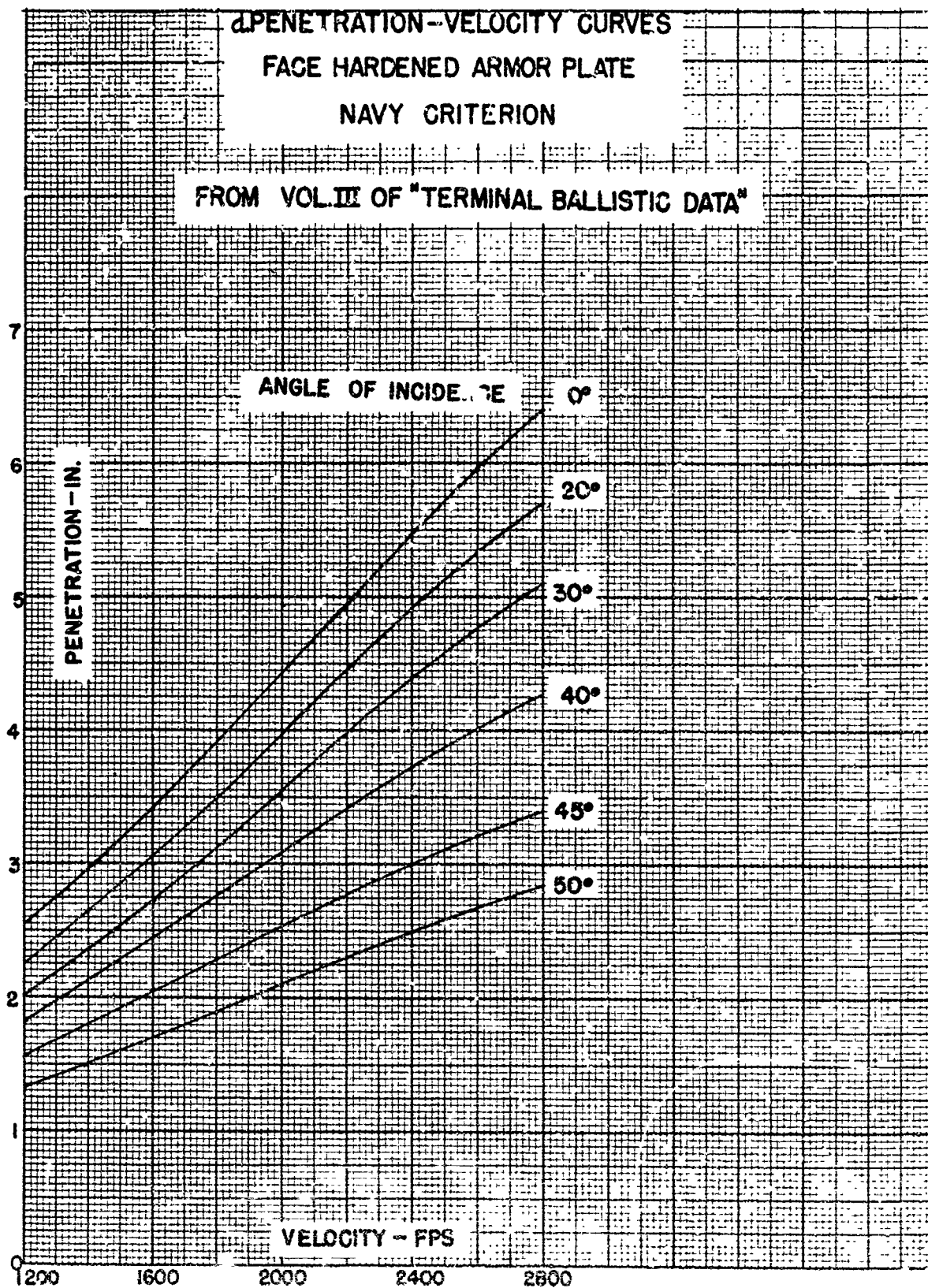

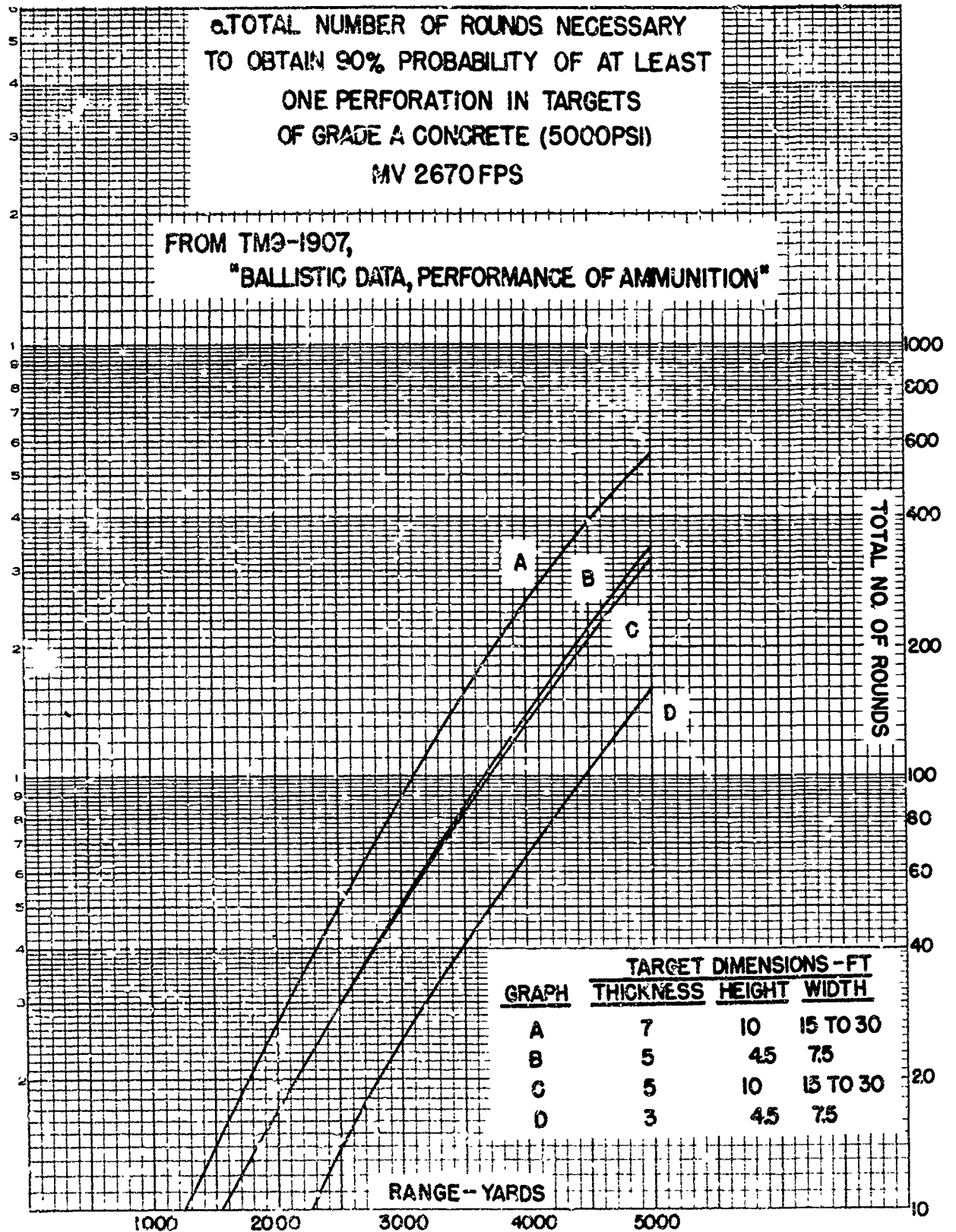

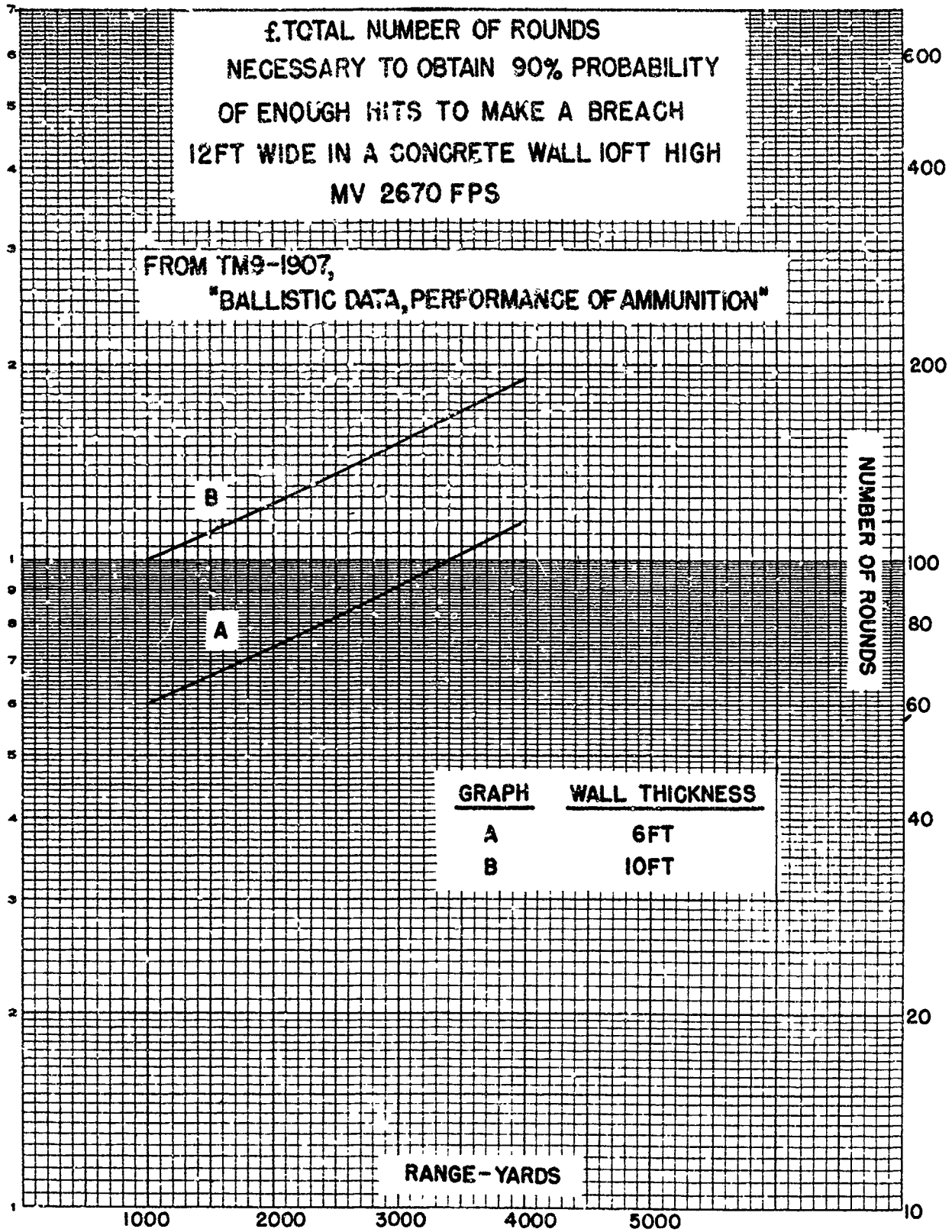

Ballistic Research Laboratories
Handbook of Ballistic and
Engineering Data for Ammunition,
No. 90-1-304

Ballistic Research Lab.
Aberdeen Proving Ground,
Maryland.
11 February 1949

BALLISTIC AND ENGINEERING DATA
for
Shot, HVAP, 90-mm, M304
with
Tracer

<u>Section</u>		<u>Paragraph</u>
I	General -----	1
II	Description -----	2 - 4
III	Interior ballistic data -----	5
IV	Exterior ballistic data -----	6 - 7
V	Effect data -----	8

SECTION I
GENERAL

	<u>Paragraph</u>
Purpose - - - - -	1

1. Purpose. The purpose of this number of the handbook is to furnish a concise collection of information regarding the shape, dynamics, ballistics, and effects of the 90-mm High Velocity Armor-piercing Shot M304 with Tracer. This information is collected from the drawings, reports, firing tables, and technical manuals pertaining to this ammunition.

ALL DIMENSIONS IN CALIBERS
1 CAL = 3.543"

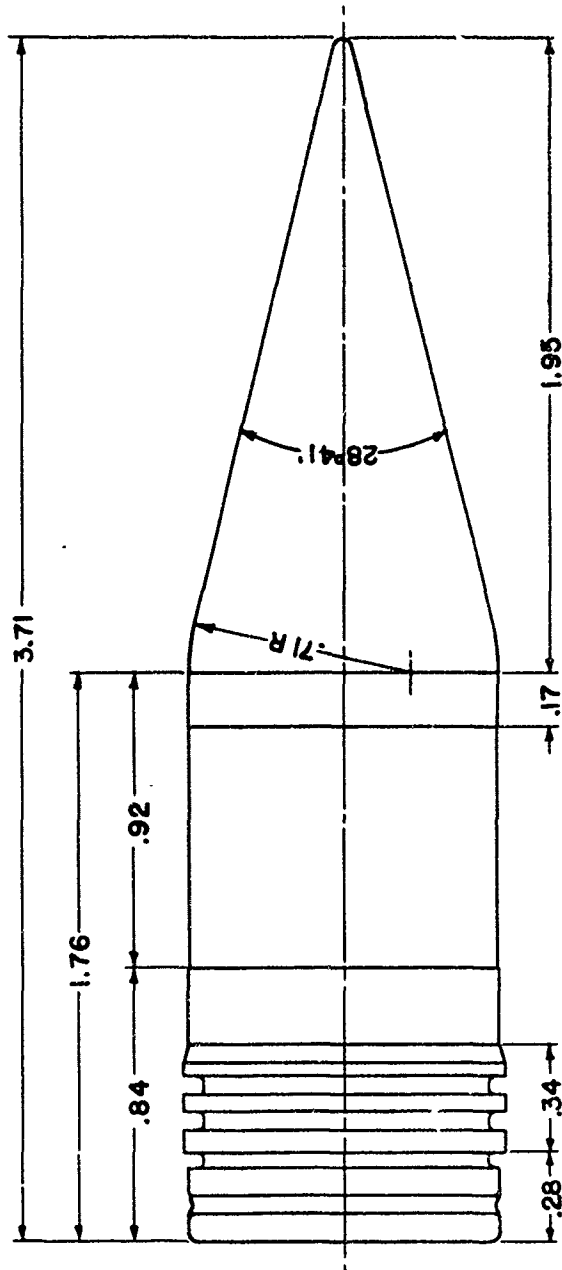

SHOT, HVAP, 90-MM, M304

SECTION II
DESCRIPTION

	<u>Paragraph</u>
Drawings - - - - -	2
Dimensions - - - - -	3
Physical characteristics - - - - -	4

2. Drawings.

Metal parts assembly	75-2-375
Details	75-2-376
Details	75-2-377

3. Dimensions.

Band: Distance from base	0.28 cal
Width	0.34 cal
Cylindrical parts: Bourrelet ring	0.17 cal
Body and ring	0.92 cal
Base	0.84 cal
Base, body and ring	1.76 cal
Windshield: Length	1.95 cal
Radius of ogival arc	0.71 cal
Conical angle	28°41'
Shot: Length	3.71 cal

4. Physical characteristics. The position of the center of gravity and the moments of inertia tabulated below pertain to the HVAP Shot T30E15, which is slightly different from the HVAP Shot M304 (T30E16).

Weight (Standard)	16.80 lb
Base to center of gravity	1.168 cal
Axial moment of inertia	20.01 lb.in ²
Transverse moment of inertia	93.89 lb.in ²

**SECTION III
INTERIOR BALLISTIC DATA**

Theoretical yaw in bore - - - - - Paragraph
5

5. Theoretical yaw in bore.

Minimum 3.3 min
Maximum 6.1 min

**SECTION IV
EXTERIOR BALLISTIC DATA**

Aerodynamic data - - - - - Paragraph 6
Firing table data - - - - - 7

6. Aerodynamic data.

a. Drag. A form factor of 1.16 relative to the G_8 drag function was determined from time-of-flight firings to a vertical target at a range of 1500 yards. The ballistic coefficient is 1.15. The drag coefficient is 0.113 at the average muzzle velocity of 3262 fps obtained in these firings, and 0.111 at the standard muzzle velocity of 3350 fps.

b. Stability. Ballistic Research Laboratory Memorandum Report 347D gives the following results obtained with the HVAP Shot T30E15, which is slightly different from the HVAP Shot M304 (T30E16):

Velocity 3325 fps
Twist of rifling 1/32
Stability factor 1.7
Moment coefficient 1.0

7. Firing table data. FT 90-F-1

Guns, 90-mm, M1, M1A1, M2, M3 and M26.
Twist of rifling 1/32.
Muzzle velocity 3350 fps.
Projectile Weight: 16.7 lb.

Standardization of the HVAP Shot M304 was recommended by OCM item 28147 and approved by OCM item 28461.

- a. Form Factor** (Proj Type 7): $i_7 = 1.475$.
- b. Ballistic Coefficient** (Proj Type 7): $C_7 = 1.109$.

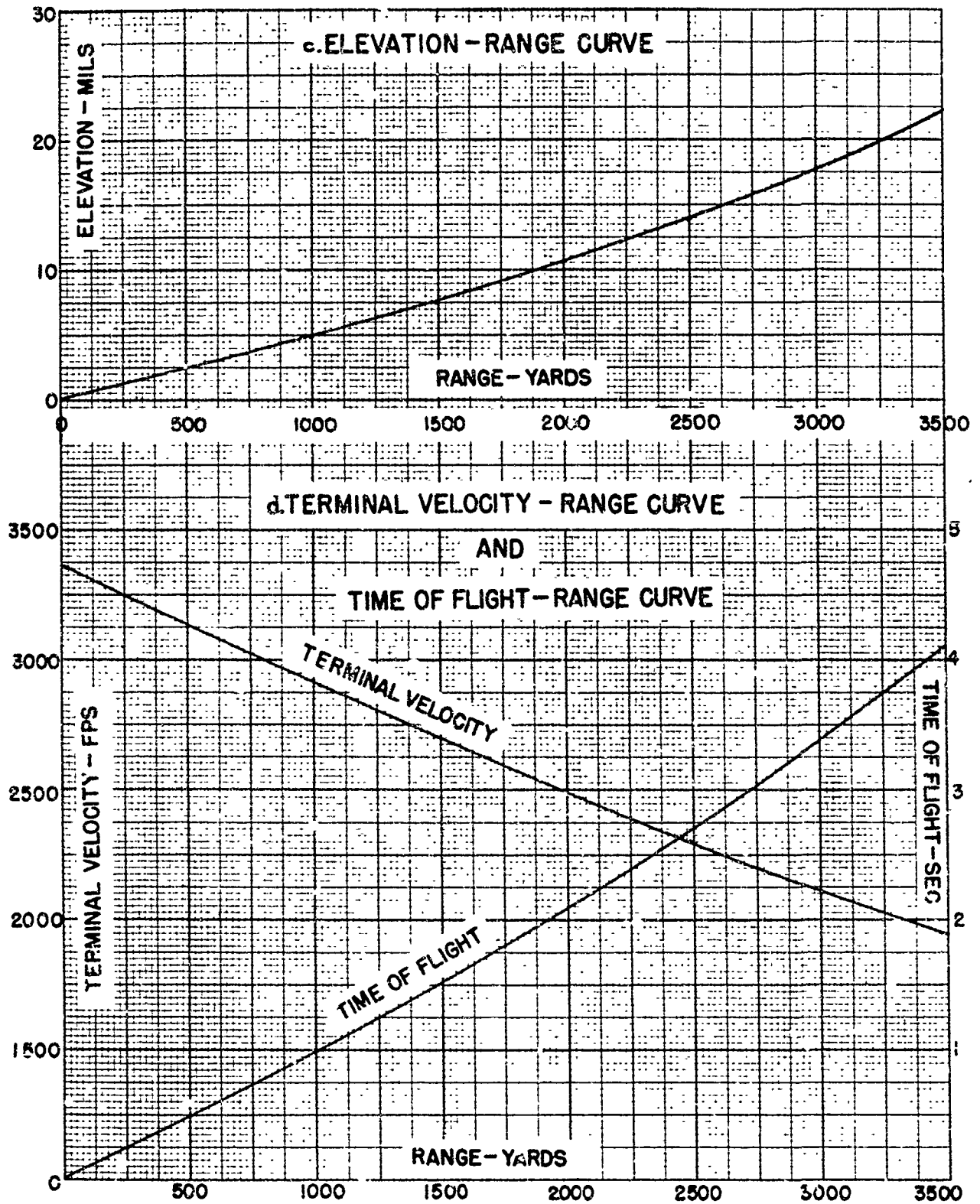

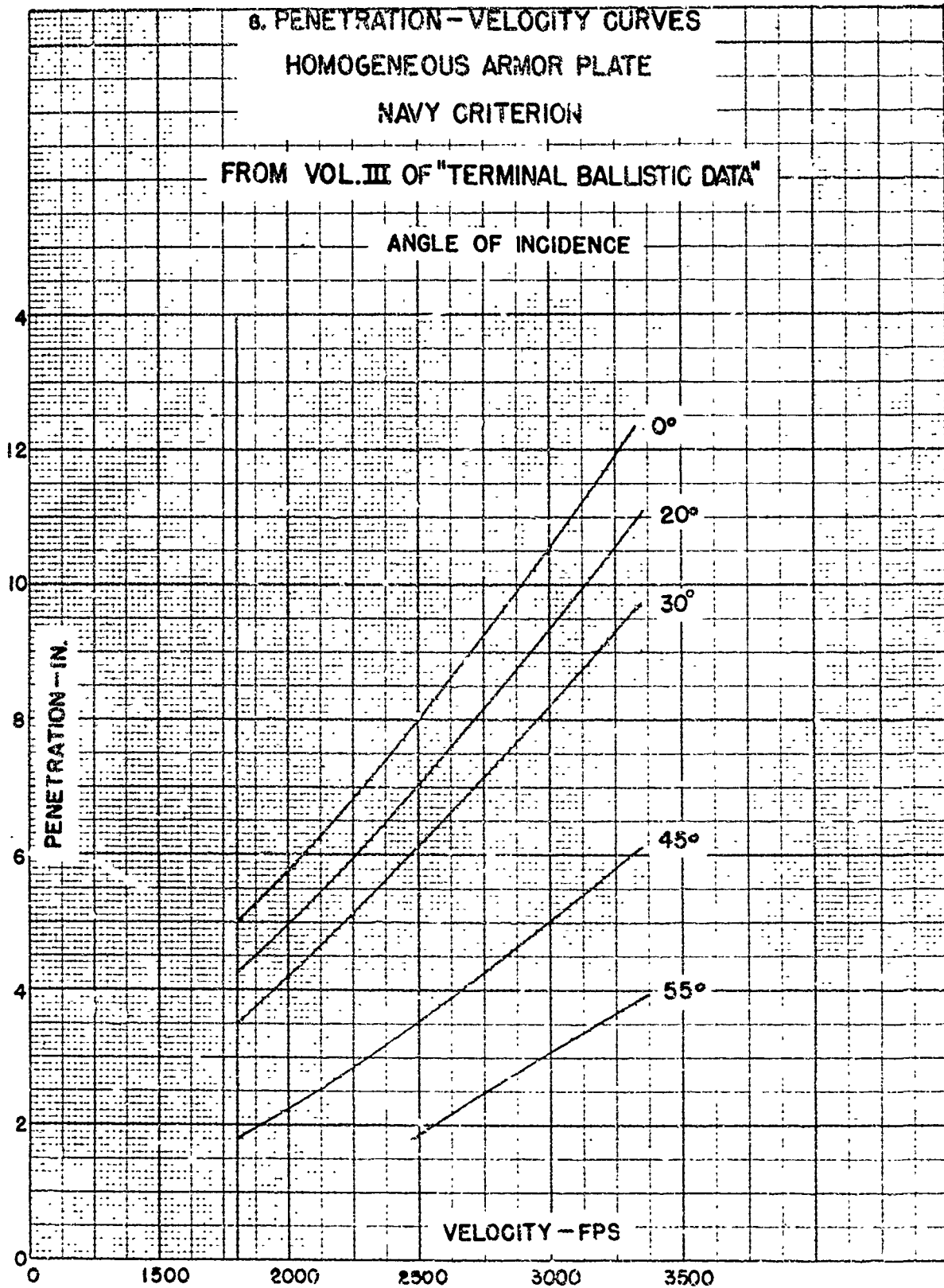

Ballistic Research Laboratories
Handbook of Ballistic and
Engineering Data for Ammunition,
No. 105-1-1

Ballistic Research Lab.
Aberdeen Proving Ground
Maryland.
11 February 1949

BALLISTIC AND ENGINEERING DATA
for
Shell, HE, 105-mm, M1
with
Fuzes, PD, M48A2 and M51A4; TSQ, M55A3; and CP, M78

<u>Section</u>	<u>Paragraph</u>
I General -----	1
II Description -----	2 - 4
III Interior ballistic data -----	5 - 6
IV Exterior ballistic data -----	7 - 8
V Effect data -----	9 - 12

SECTION I
GENERAL

	<u>Paragraph</u>
Purpose - - - - -	1

1. Purpose. The purpose of this number of the handbook is to furnish a concise collection of information regarding the shape, dynamics, ballistics and effects of the 105-mm High Explosive Shell M1 with the Point Detonating Fuze M48A2 or M51A4, the Time and Superquick Fuze M55A3, or the Concrete-piercing Fuze M78. This information is collected from the drawings, reports, firing tables, and technical manuals pertaining to this ammunition.

ALL DIMENSIONS IN CALIBERS

1 CAL. = 4.134 IN

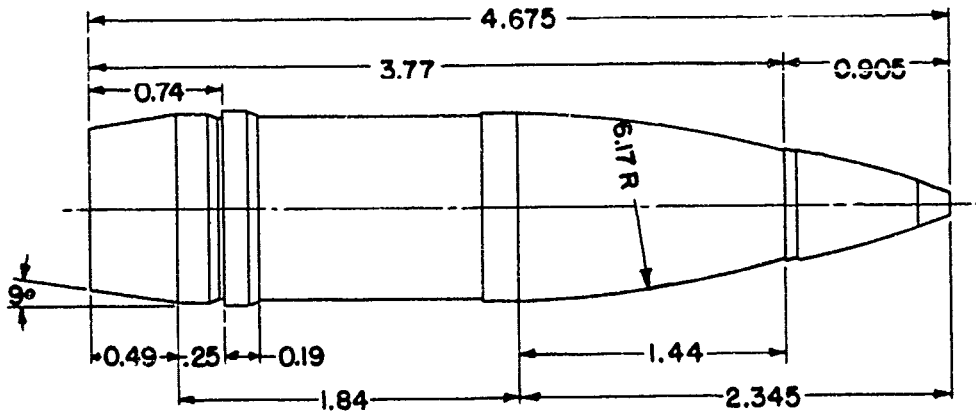

SHELL, HE, 105-MM, M1

FUZE, PD, M48A2 OR M51A4, OR T SQ, M55A3

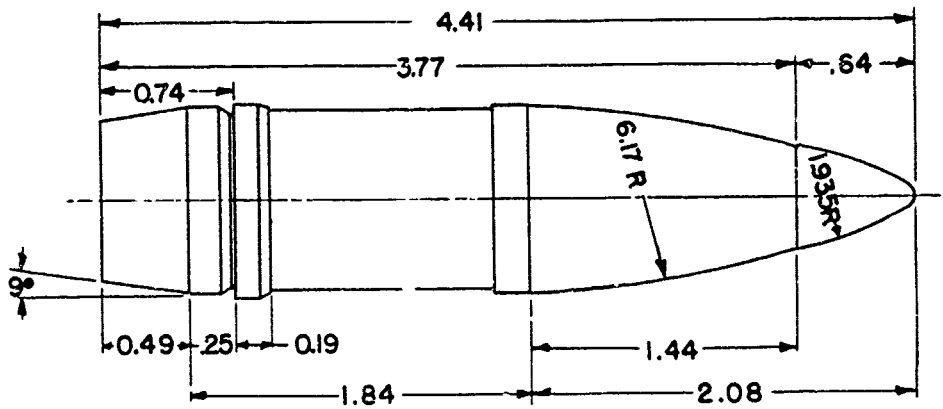

SHELL, HE, 105-MM, M1

FUZE, CP, M78

SECTION II
DESCRIPTION

	<u>Paragraph</u>
Drawings - - - - -	2
Dimensions - - - - -	3
Physical characteristics - - - - -	4

2. Drawings.

Shell: Metal parts shipping assembly, marking diagram and details	75-4-75
Booster, M20A1: Assembly and details	73-2-112
Booster, M21A4: Assembly	73-2-154
Fuze, PD, M48A2: Assembly	73-2-140
Fuze, PD, M51A4: Assembly	73-2-145
Fuze, TSQ, M54: Assembly	73-3-154
Fuze, TSQ, M55A3: Assembly	73-3-155
Fuze, CP, M78: Assembly and details	73-2-214

Note: The PD fuzes require one of the boosters. The TSQ Fuze M55A3 is the M54 Fuze with the M21A4 booster. The CP fuze contains the working parts of the boosters.

3. Dimensions.

Boattail: Angle	9°00'
Length	0.49 cal
Band: Distance from boattail	0.25 cal
Distance from base	0.74 cal
Width	0.19 cal
Cylindrical body: Length	1.84 cal
Ogive: Length	1.44 cal
Radius of arc	6.17 cal
Shell, unfuzed: Length	3.77 cal
Fuze, PD, M48A2 or M51A4, or TSQ, M55A3:	
Outside length	0.905 cal
Ogive and fuze	2.345 cal
Shell and fuze	4.675 cal
Fuze, CP, M78:	
Outside length	0.64 cal
Radius of arc	1.935 cal
Ogive and fuze	2.08 cal
Shell and fuze	4.41 cal

4. Physical characteristics.

Fuze	Mean Weight lb			Base to Center of Gravity cal	Moments of Inertia lb.ft ²	
	Marking				Axial	Transverse
TSQ M55	32.4	33.0	33.6	1.739	0.554	5.345
Dummy M59	32.4	33.0	33.6	1.749	0.5506	5.399
CP M78	33.0	33.6	34.2			

Note: The physical characteristics with all modifications of the PD and TSQ fuzes are approximately the same as with the TSQ Fuze M55. The Dummy Fuze M59 has the same contour as the TSQ Fuze M55.

SECTION III
INTERIOR BALLISTIC DATA

	Paragraph
Stresses - - - - -	5
Theoretical yaw in bore - - - - -	6

5. Stresses. The following table and the graphical representation on page 5 show the longitudinal, radial and tangential resultant stresses at each of two sections: (A) the rear corner of the band seat and (B) the front of the band seat.

Howitzers	M2A1, M3, M4
Twist of rifling	1/20
Cross-sectional area of bore	13.65 sq in.
Rated maximum pressure	28,000 psi**
Total weight of projectile	33.00 lb
Muzzle Velocity	1550 fps
Density of filler (TNT)	0.057 lb per cu in.

Resultant Stress*	Section	
	A	B
100 psi		
Longitudinal	-101	-320
Radial	+300	- 89
Tangential	-603	+400

* + denotes tension, - denotes compression.

** Since these stresses were calculated, the rated maximum pressure has been increased to 30,000 psi (OCM item 17072)

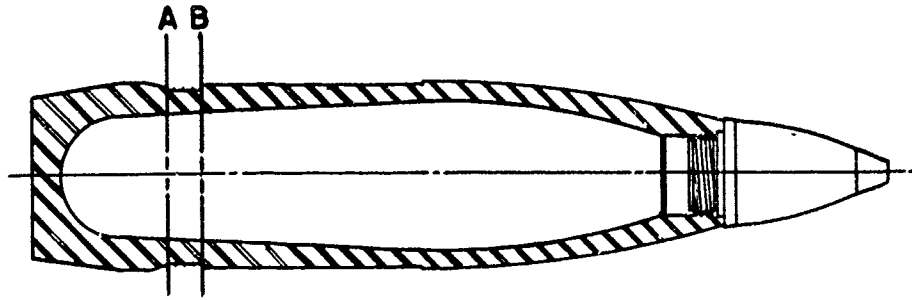

SECTION

A

B

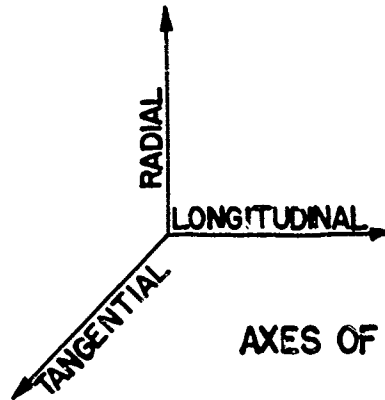
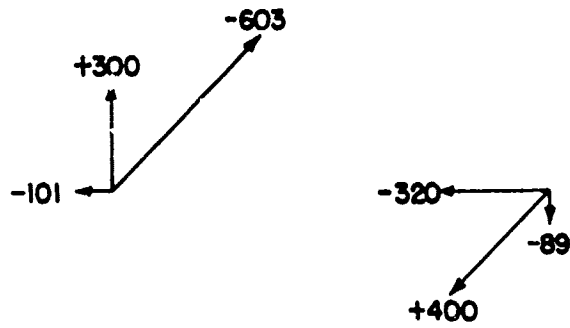

AXES OF RESULTANT STRESS

DIAGRAM OF RESULTANT STRESSES

6. Theoretical yaw in bore.

Minimum	2.7 min
Maximum	5.0 min

**SECTION IV
EXTERIOR BALLISTIC DATA**

Aerodynamic data - - - - -	<u>Paragraph</u>
Firing table data - - - - -	7
	8

7. Aerodynamic data.

a. Drag. The graph of drag coefficient vs. Mach number (p. 7) was determined by resistance firings of the HE Shell M1 with the PD Fuze M48. The graph of drag coefficient vs. yaw (p. 8) was determined by measurements of a wooden model of the same projectile, made by the Bureau of Standards in an air stream with a speed of 45 fps. The form factor of the HE Shell M1 with the CP Fuze M78, determined by resistance firings, is 0.93 relative to G_5 at a velocity of 1519 fps; the corresponding drag coefficient is 0.161.

b. Stability. The graph of moment coefficient vs. yaw (p. 9) was determined by measurements of a wooden model of the HE Shell M1 with the PD Fuze M48, made by the Bureau of Standards in an air stream with a speed of 45 fps. The data tabulated below were determined by stability firings of the HE Shell M1 with the Dummy Fuze M59, fired from the 105-mm Howitzer M2A1 (see BRL Memorandum Report No. 265, "Stability of 105-mm HE Shell M1"), and with the TSQ Fuze M55, fired from the 105-mm AA Gun T4.

Fuze	Dummy M59	TSQ M55
Muzzle Velocity	1550 fps	2675 fps
Moment coef. K_M	1.41	1.28
Twist of rifling	1/20	1/30
Stability factor	2.69	1.35

c. Drift. FT 105-H-3 and FT 105-L-2 give the drift for the 105-mm howitzers firing the HE Shell M1 with PD and TSQ fuzes. The graph of cross wind force coefficient vs. yaw (p.10) was determined by measurements of a wooden model of the shell with PD fuze, made by the Bureau of Standards in an air stream with a speed of 45 fps.

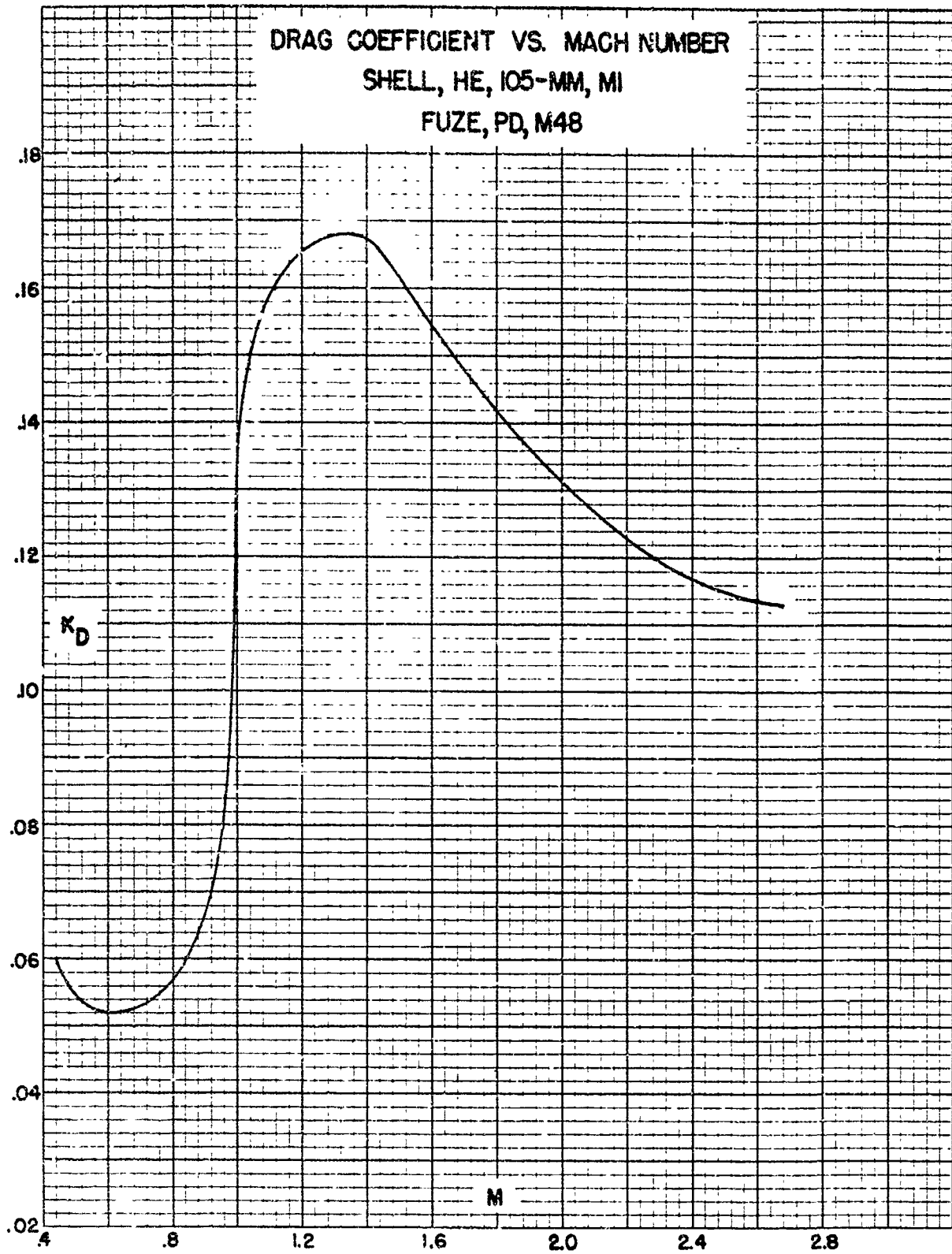

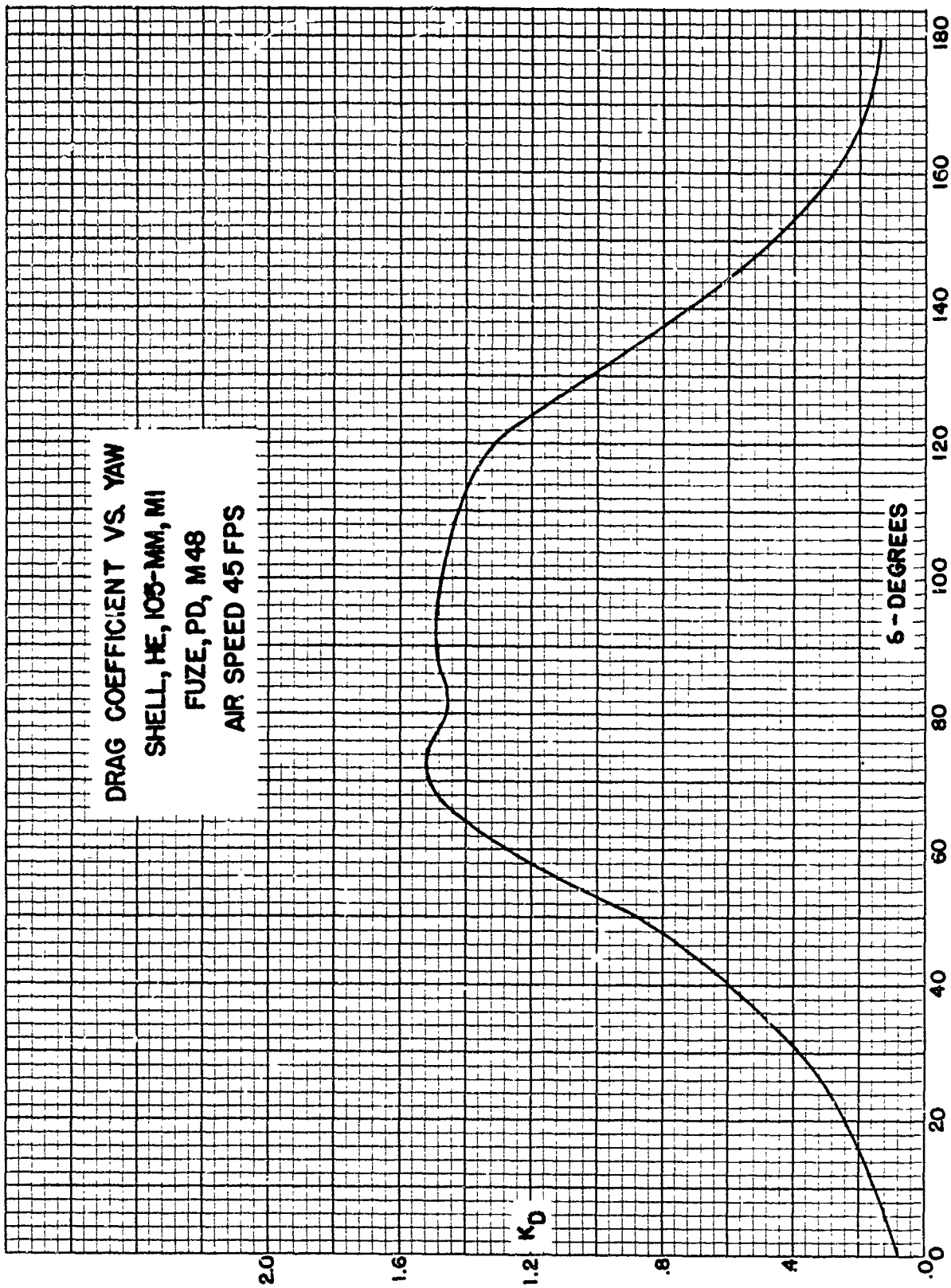

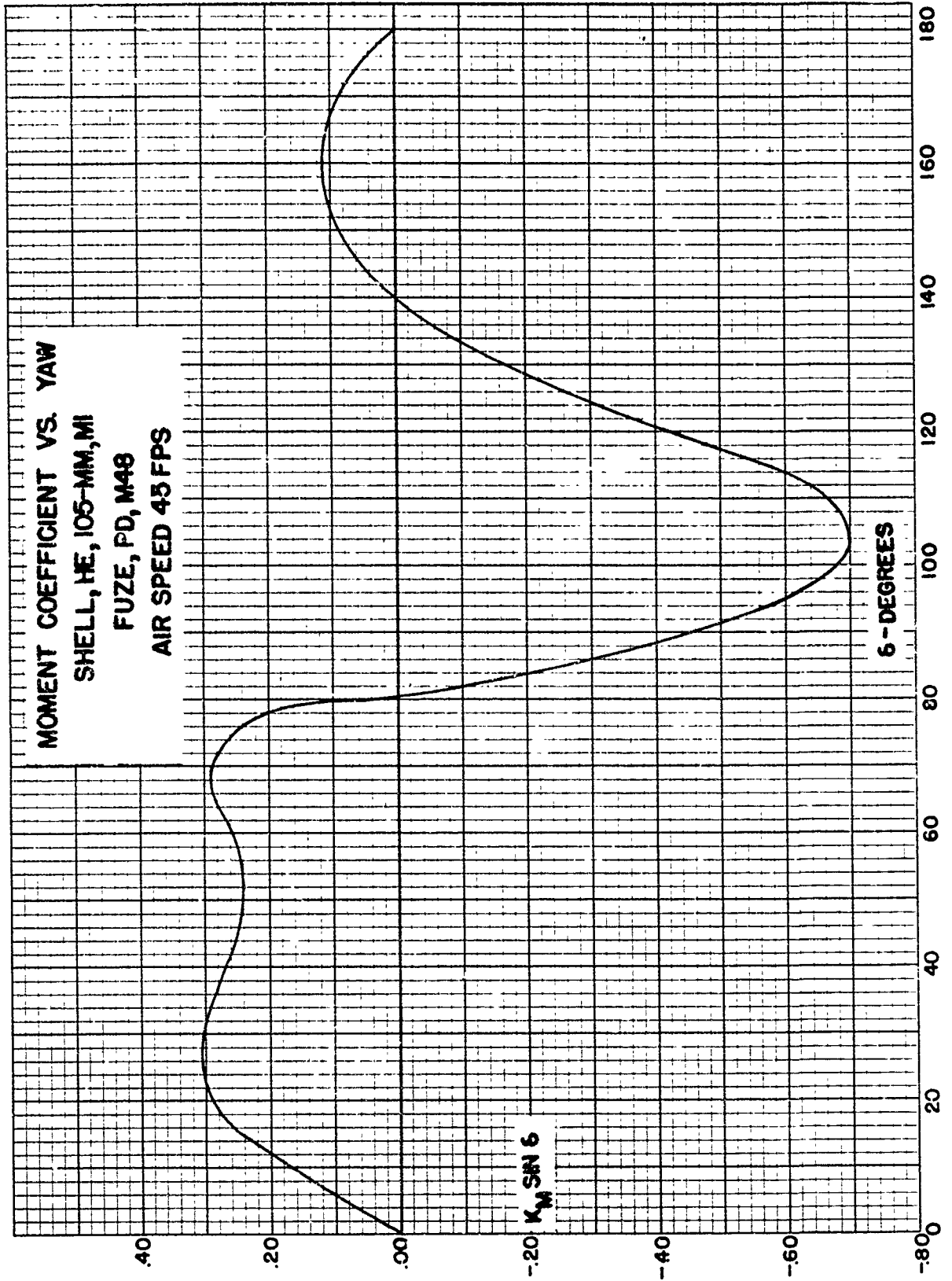

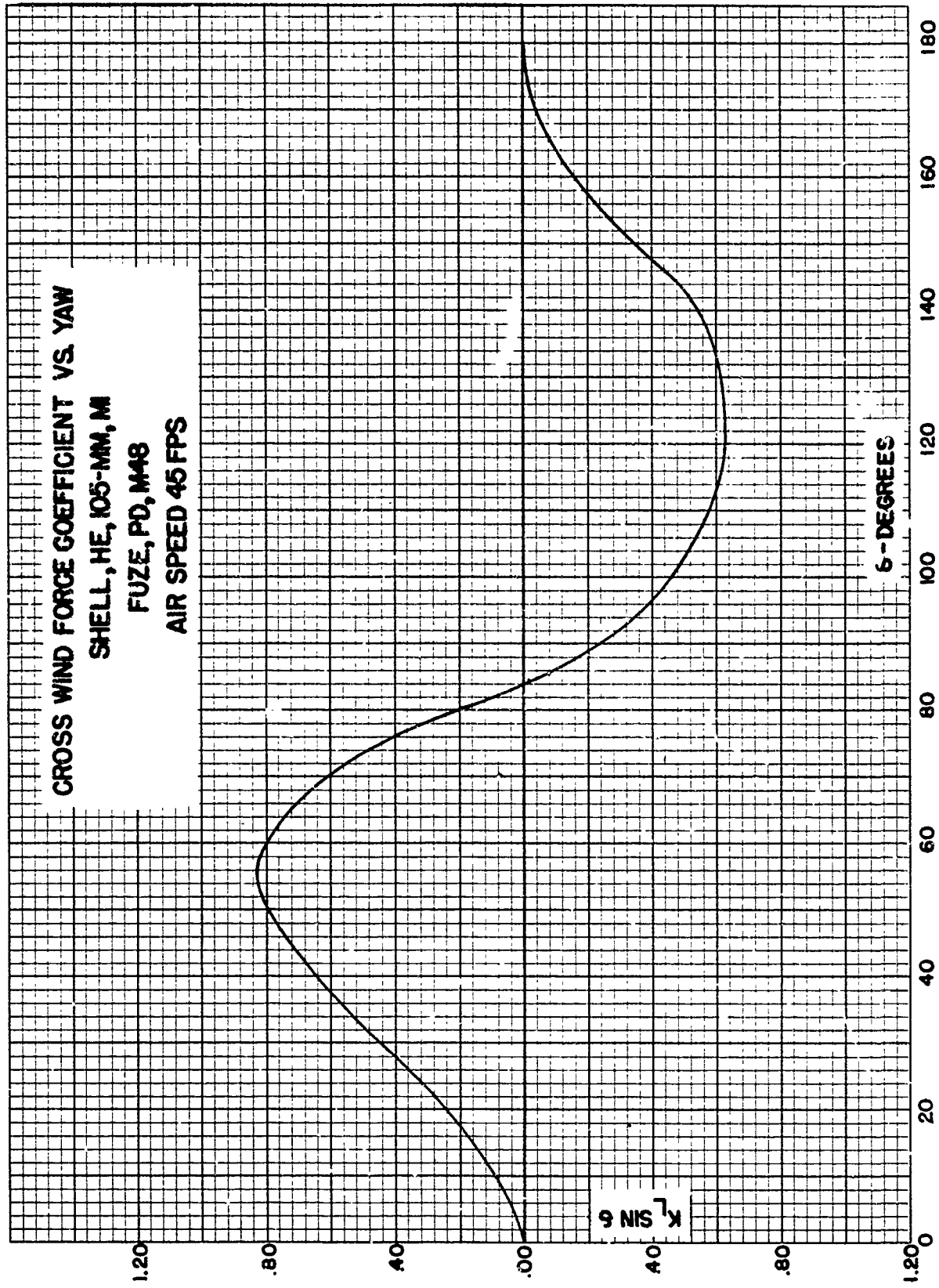

8. Firing table data.

FT 105-H-3 with C8 contains data for 105-mm Howitzer M2A1 on Carriage M2, firing HE Shell M1 with PD and TSQ fuzes, and FT 105-L-2 with C4, for 105-mm Howitzer M3 on Carriage M3, firing HE Shell M1 with PD and TSQ fuzes. FT 105-H-3 is also applicable to the 105-mm Howitzer M2A1 on Carriage M2A2 or Motor Carriage M7 or M7B1, and the Howitzer M4 in Medium Tank M4 or M4A3 or Motor Carriage T76, providing the corrections listed in C8 be applied to the elevation and drift. These tables may be used for the HE Shell M1 with the CP Fuze M78 providing corrections be made for weight and air resistance: the weight of the shell with the CP fuze is greater than that of one with the PD fuze with the same marking by the amount indicated by a difference of one square; the increase in air resistance is equivalent to one percent increase in air density.

The twist of rifling of all these howitzers is 1/20.

The semi-fixed rounds are assembled with charges to give the following muzzle velocities:

Charge No.	Howitzer M2A1 or M4 Round for How		Howitzer M3
	M2A1	M3	Round for How M3
1	650	695	650
2	710	755	710
3	780	825	780
4	875	925	875
5	1020	1080	1020
6	1235		
7	1550		

OCM item 11871 approved the recommendation by item 11820 that the HE Shell M1 be standardized for the 105-mm Howitzer M2 (later superseded by M2A1). OCM item 19910 approved the recommendations by item 19684 that the 105-mm Howitzer M3 and Carriage M3 be standardized, and that the HE Shell M1 with PD Fuze M48A1 be assembled as a semi-fixed round capable of being fired in this howitzer at the first five zone velocities of the M2A1 Howitzer. OCM item 23702 approved the recommendations by item 23180 that the semi-fixed round for the M3 Howitzer be made substitute standard for the M2 and M2A1 Howitzers, and that the round for the M2 and M2A1 Howitzers be not used in the M3 Howitzer except under conditions of extreme emergency, in which event only charges 1, 2 and 3 may be used. OCM item 22131 approved the recommendation of item 21869 that the 105-mm Howitzer M4 be standardized for use in the Medium Tank M4 or M4A3 (the ballistics of this howitzer are the same as those of the M2A1 Howitzer).

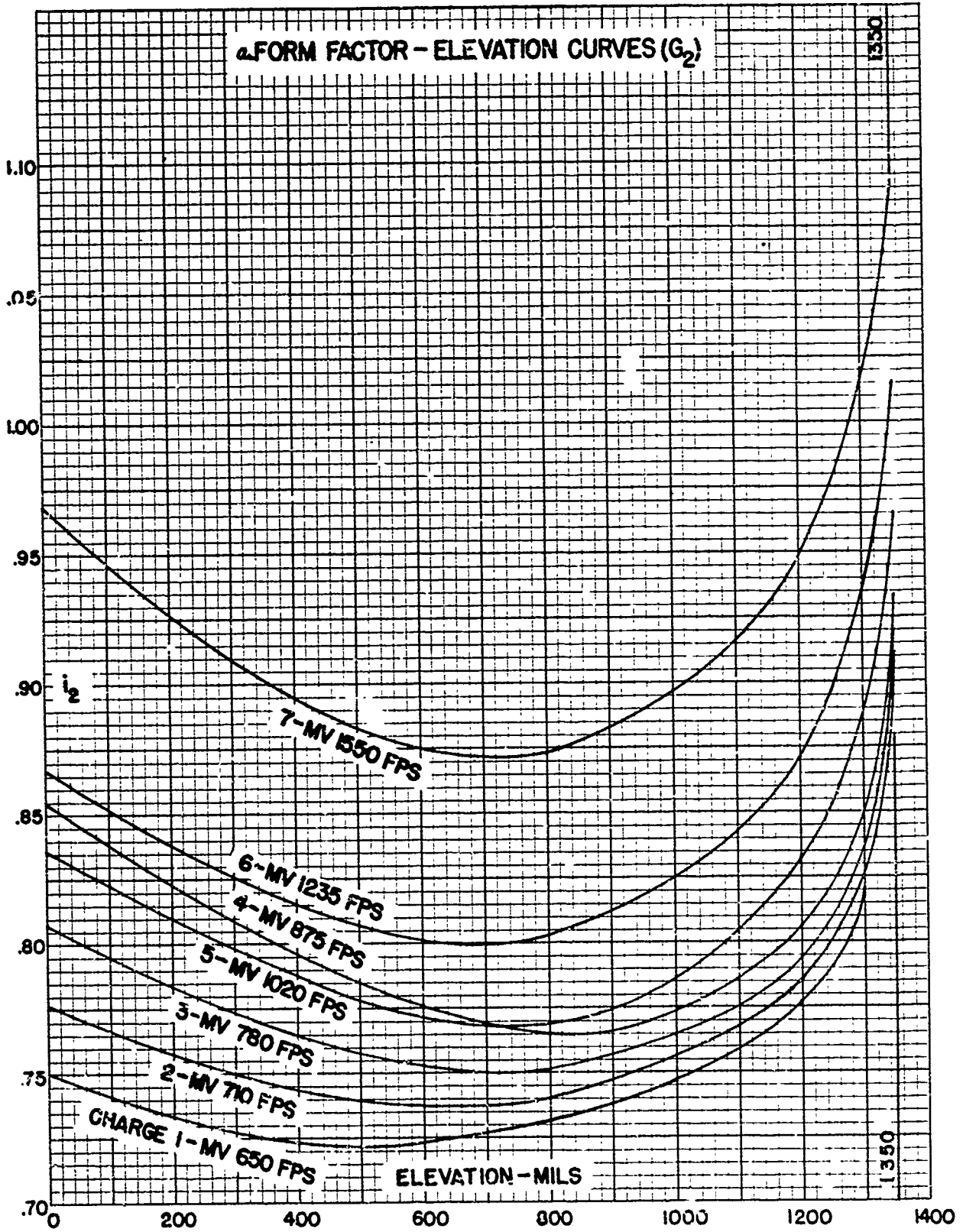

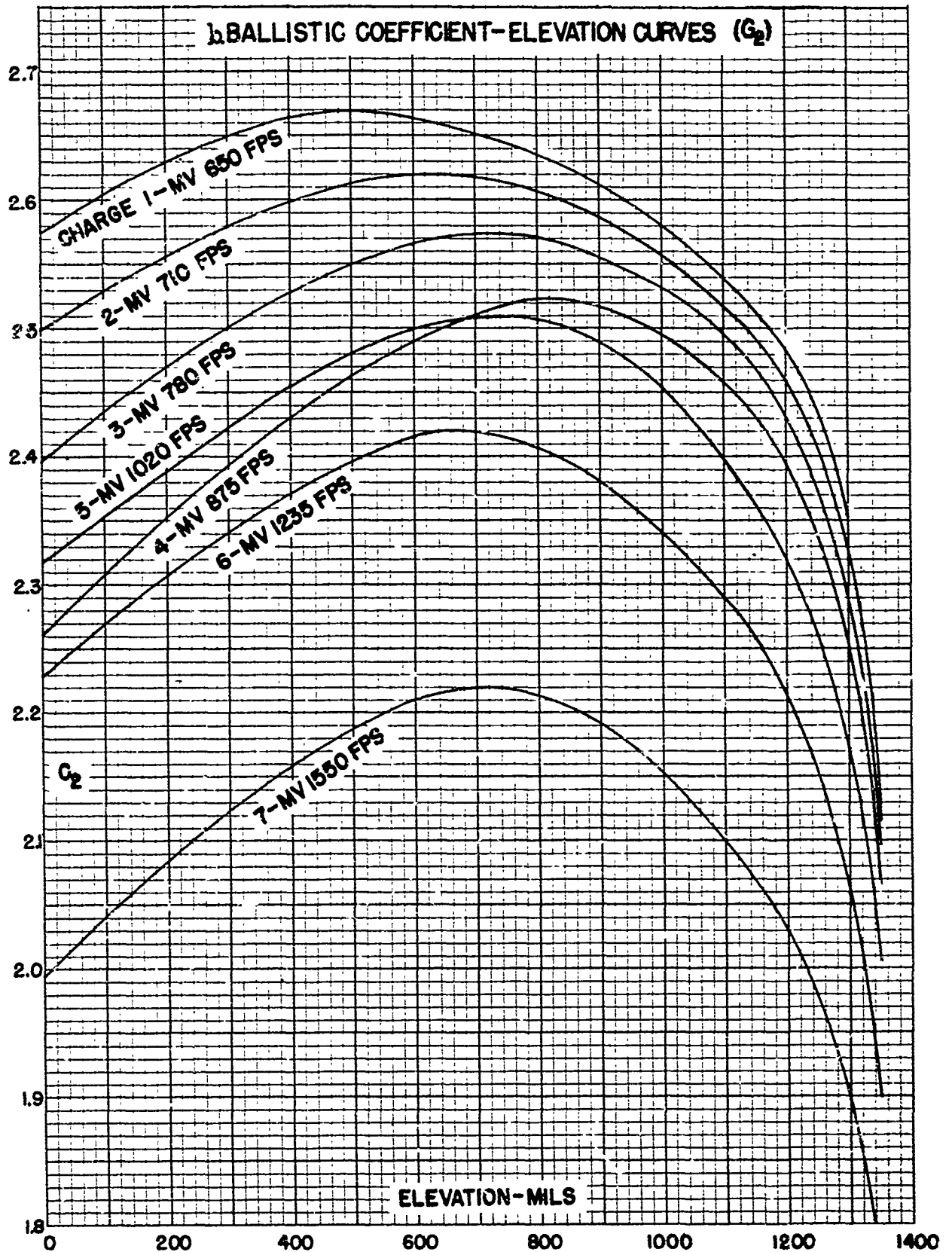

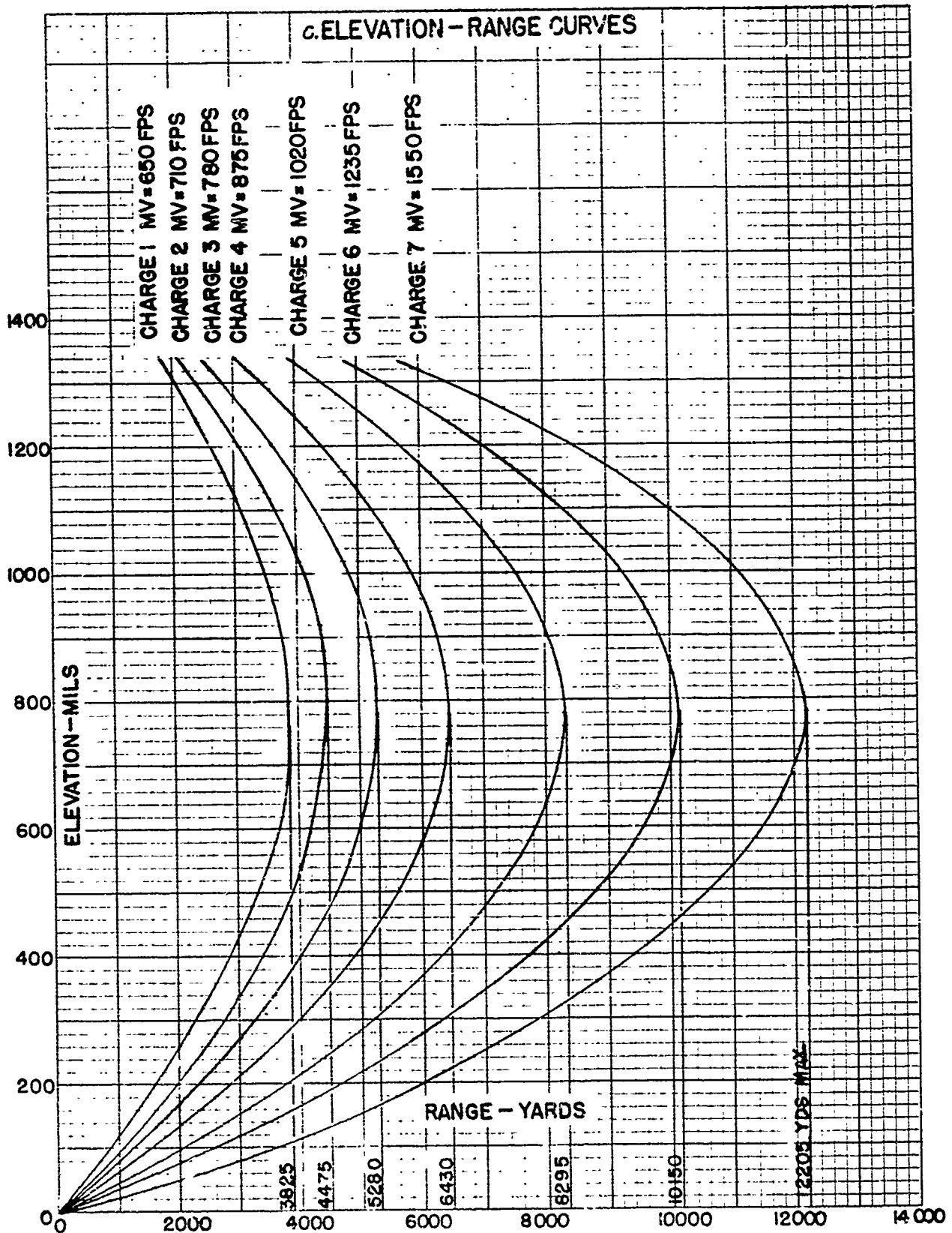

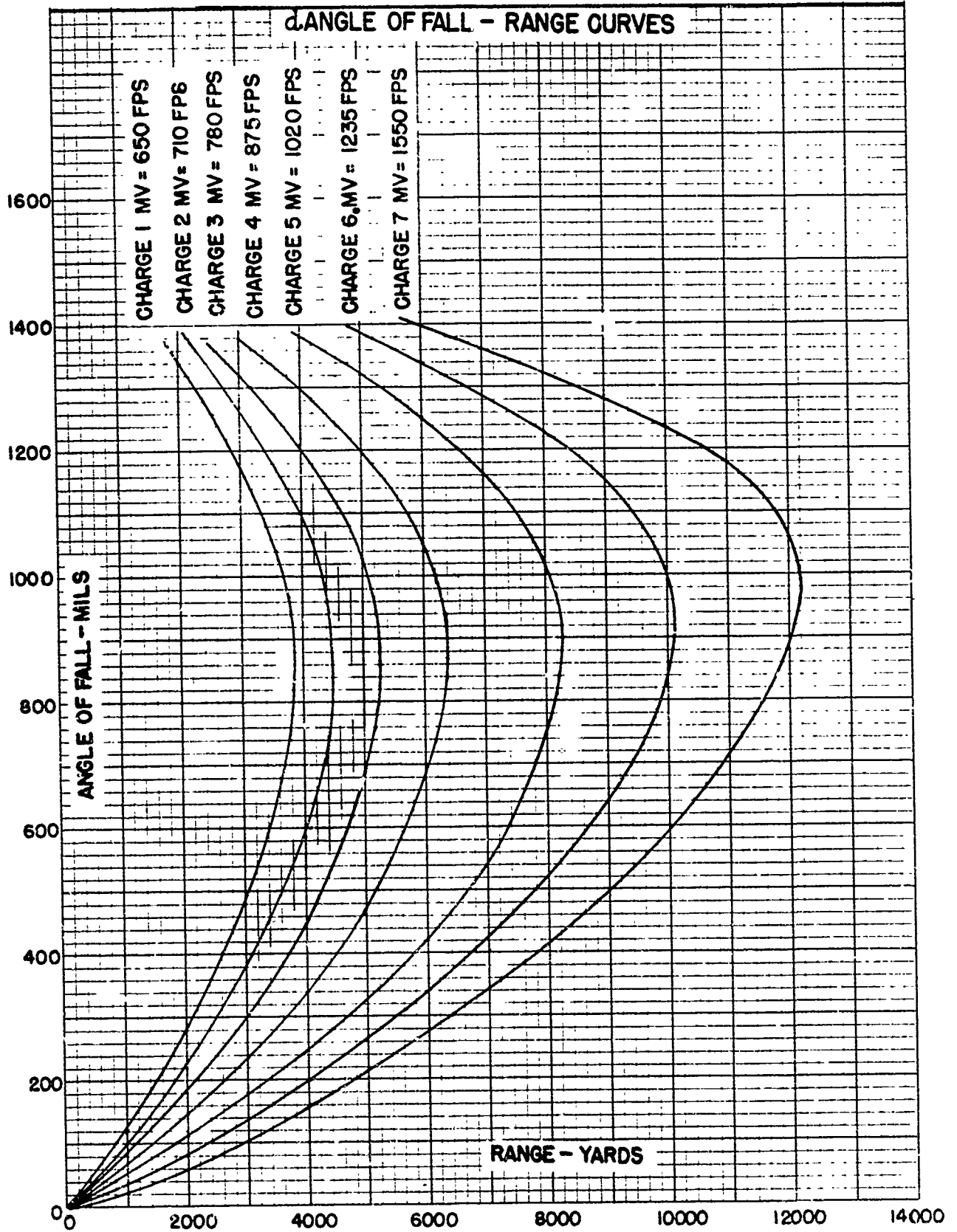

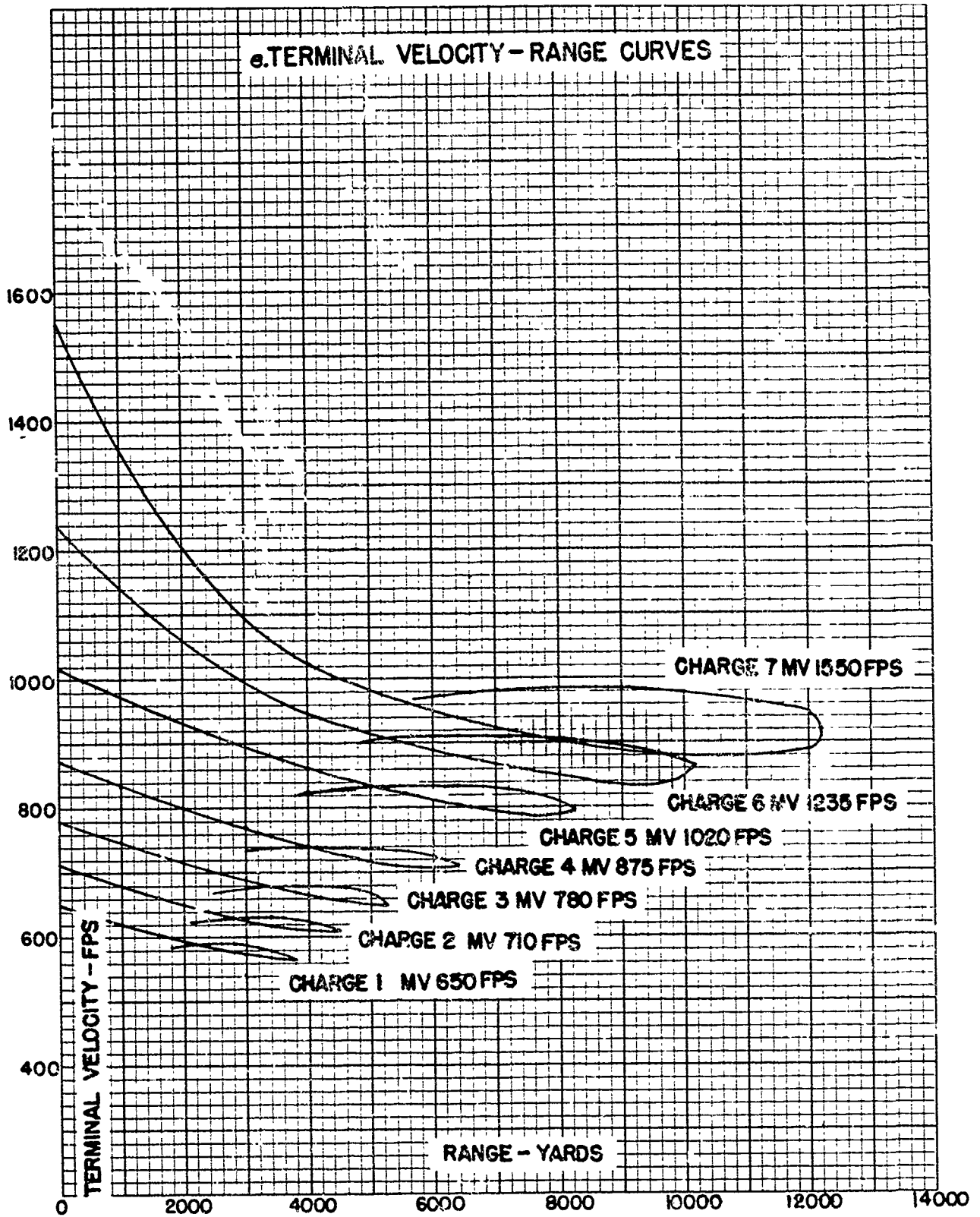

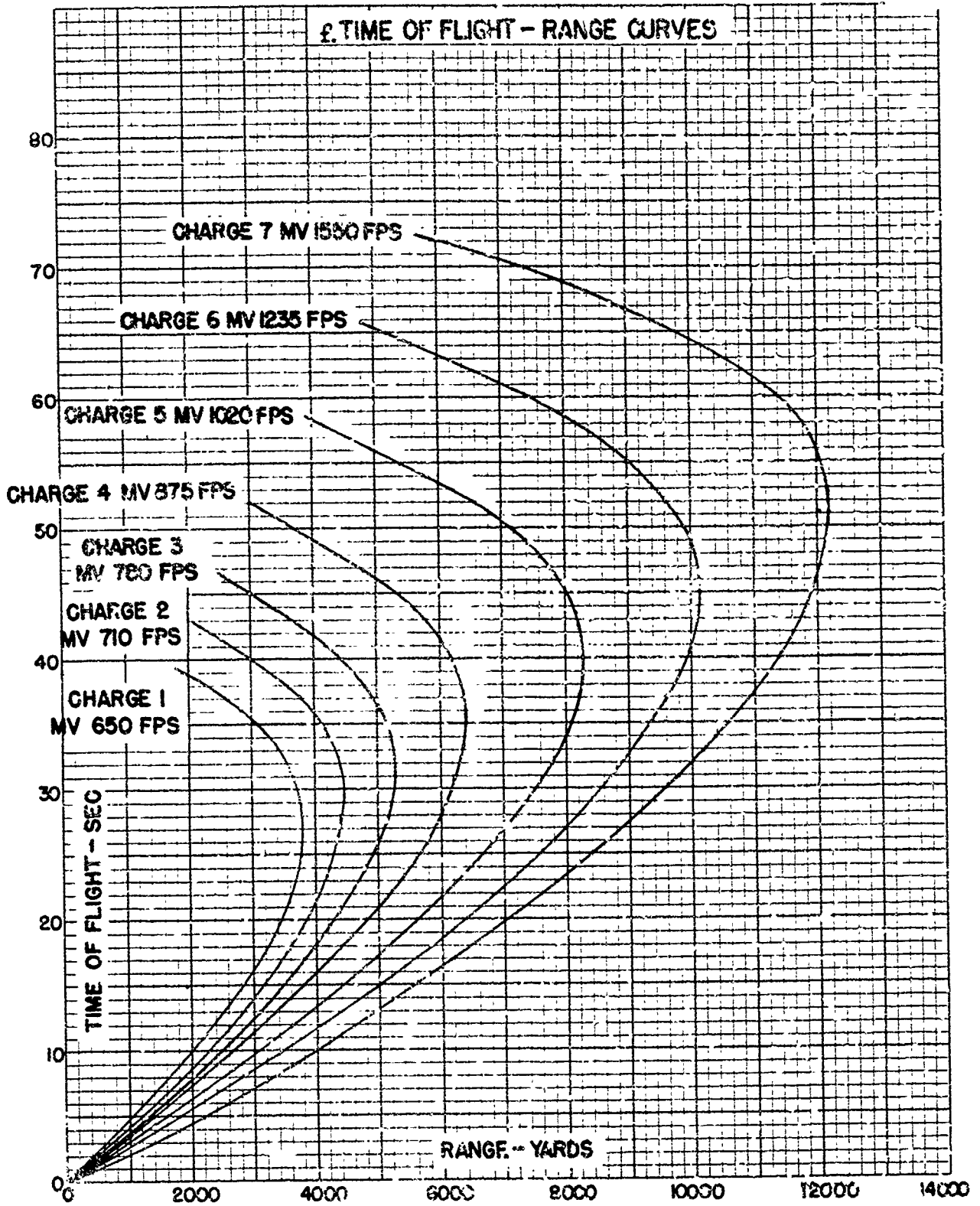

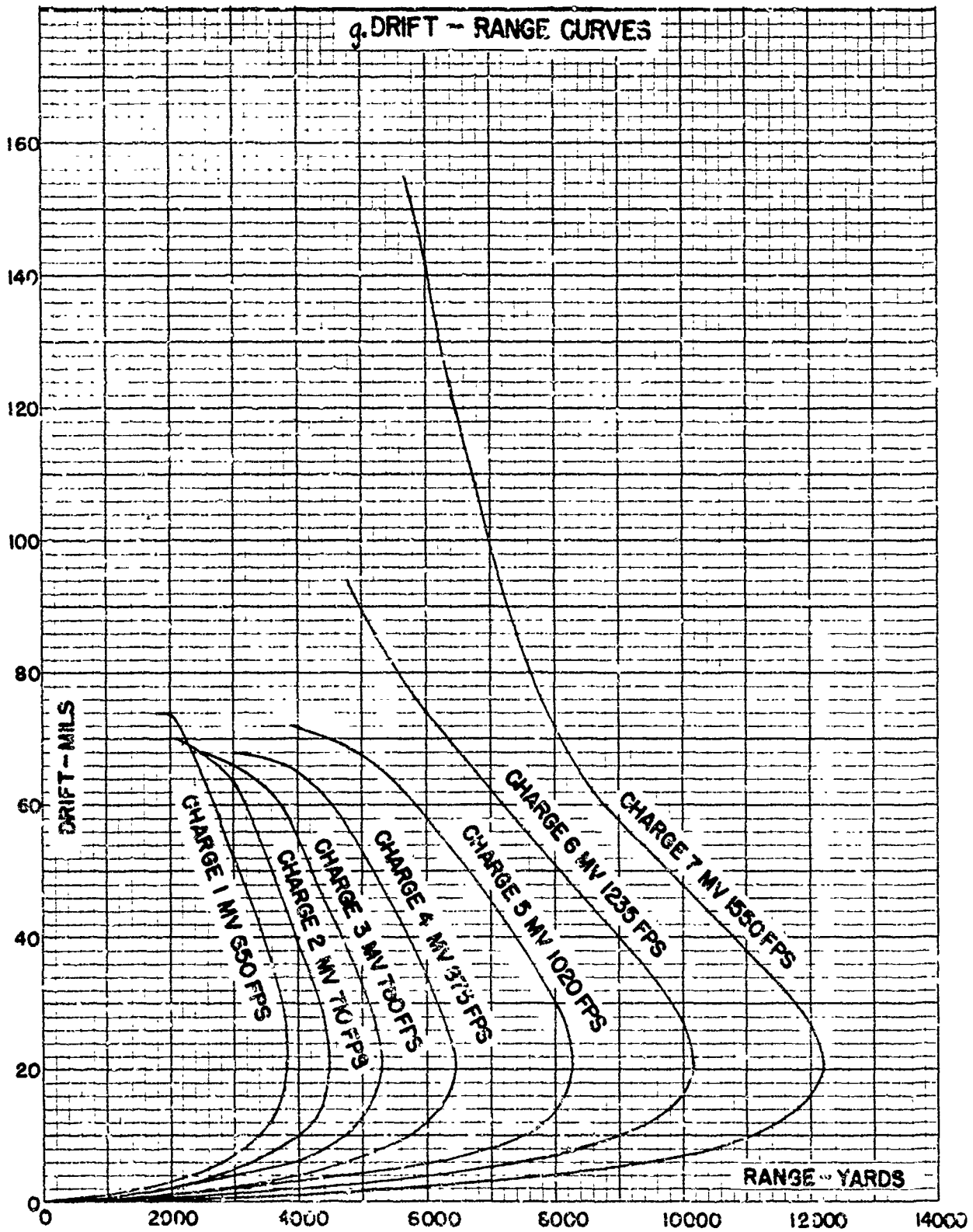

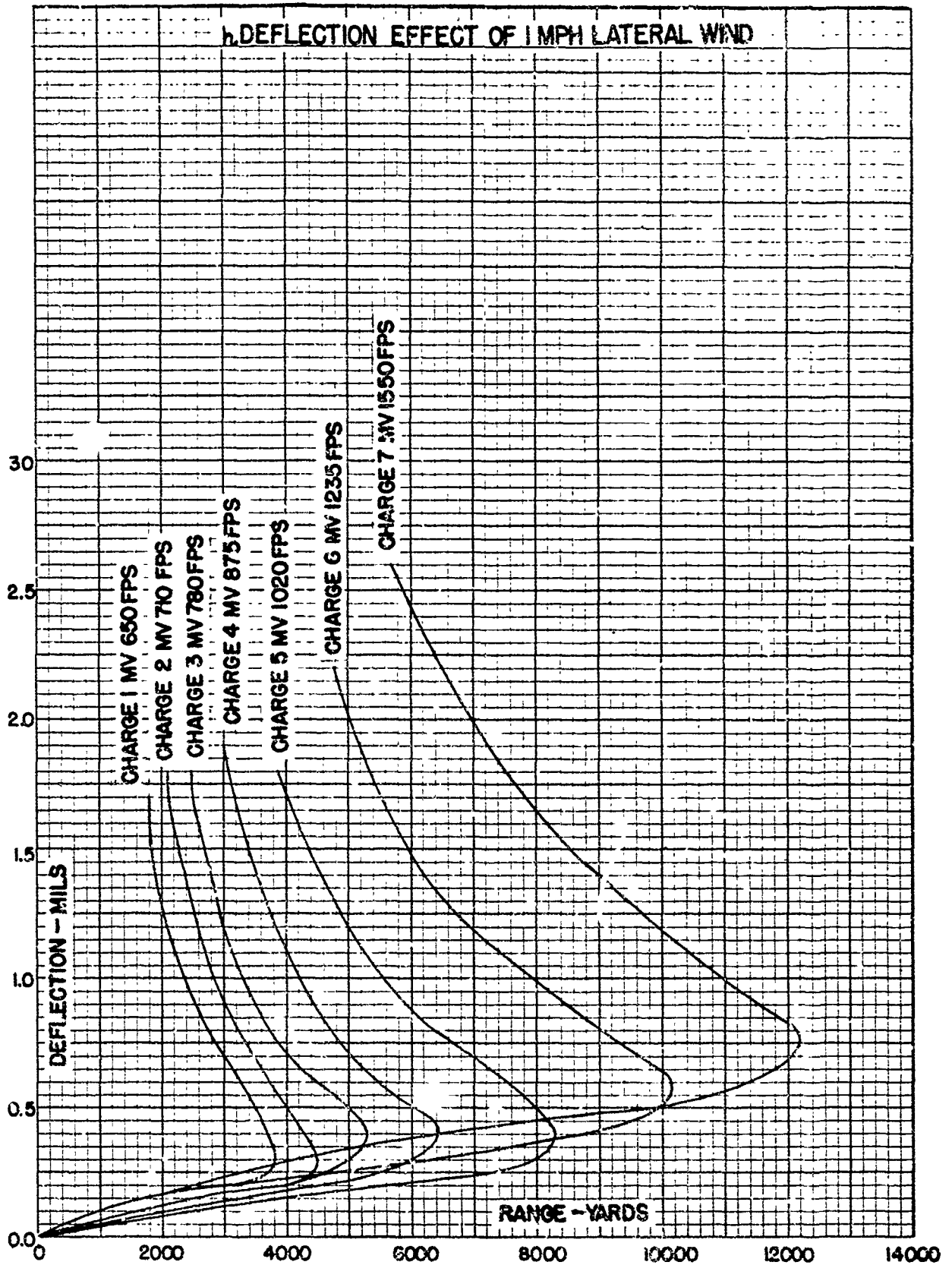

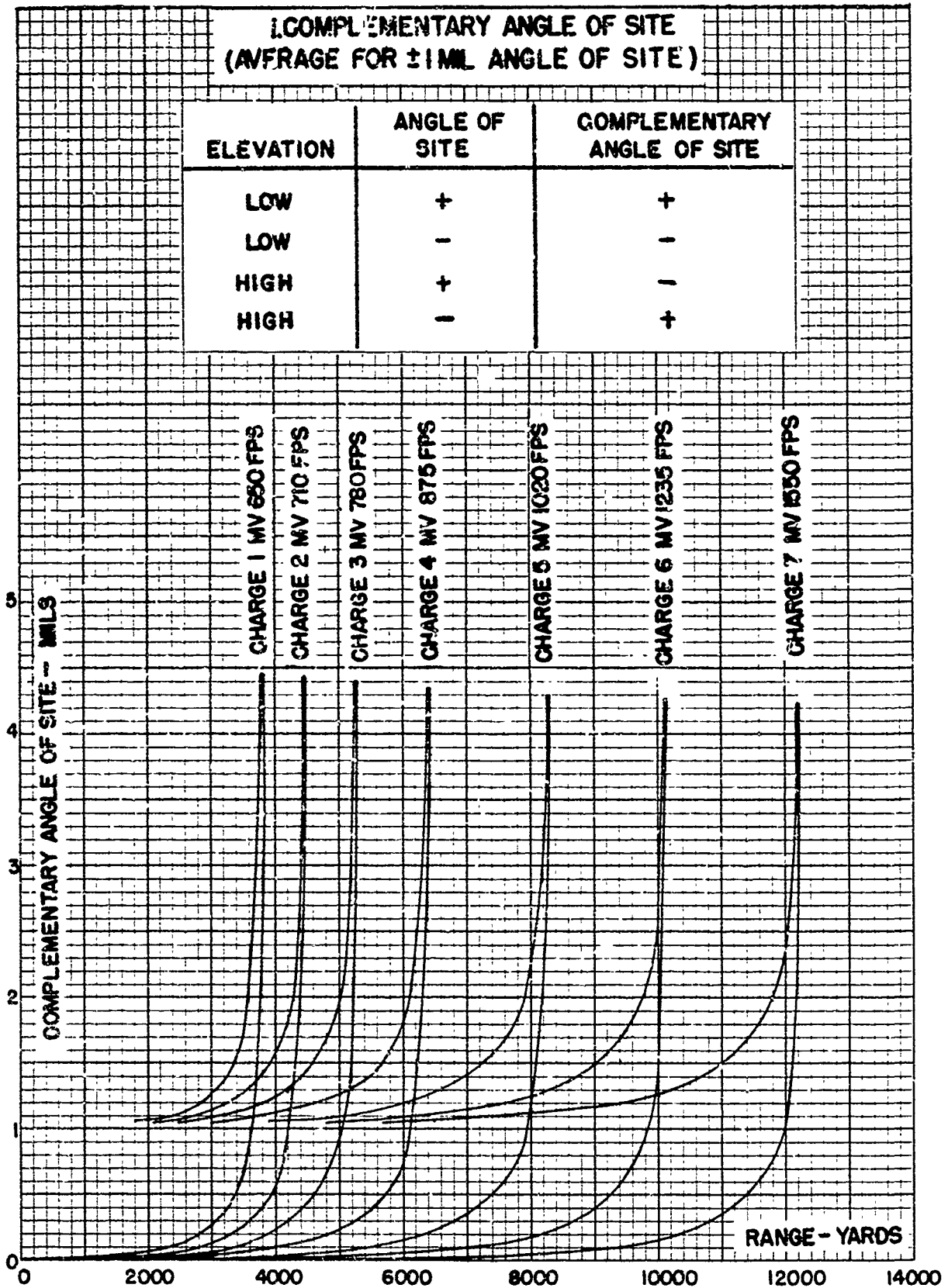

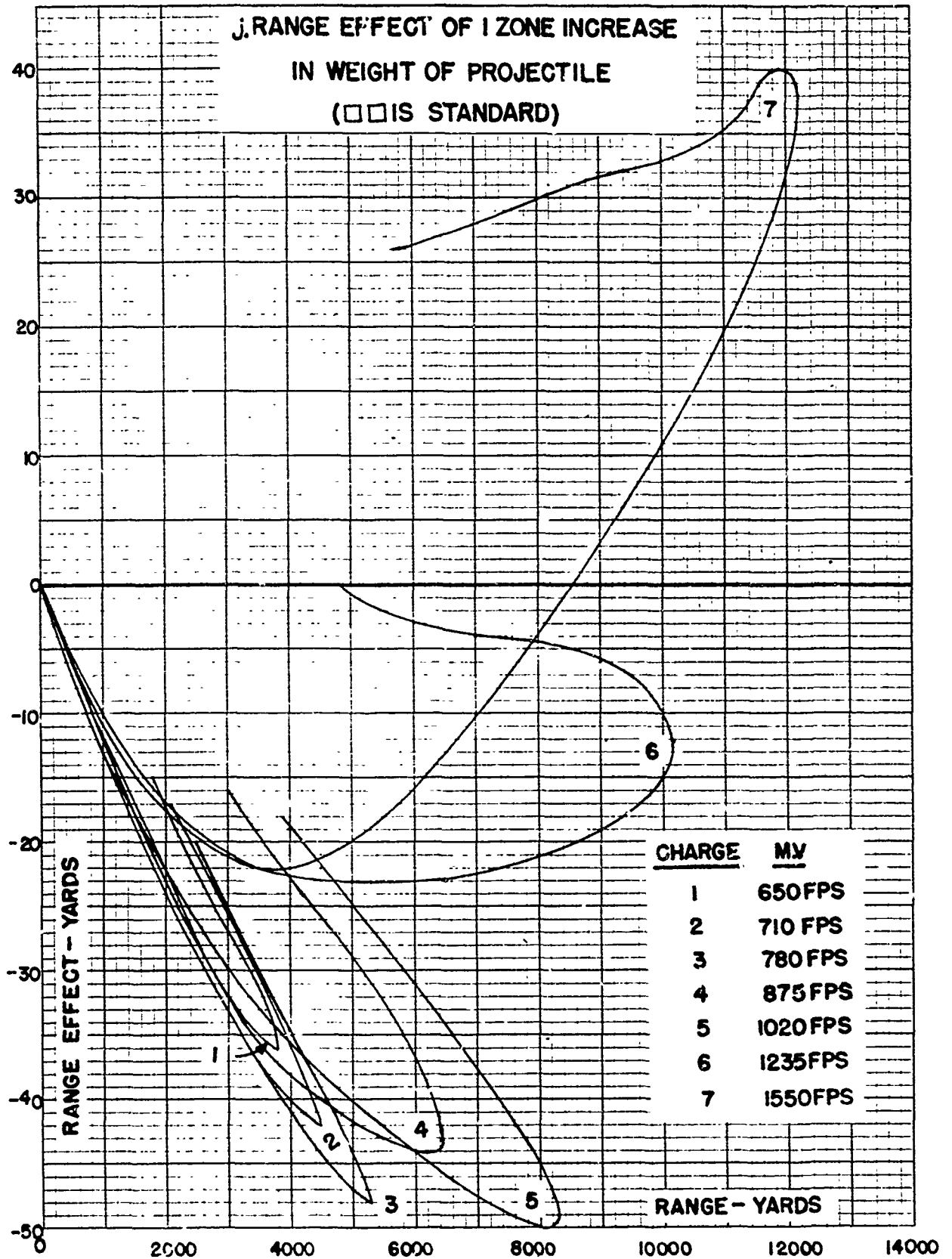

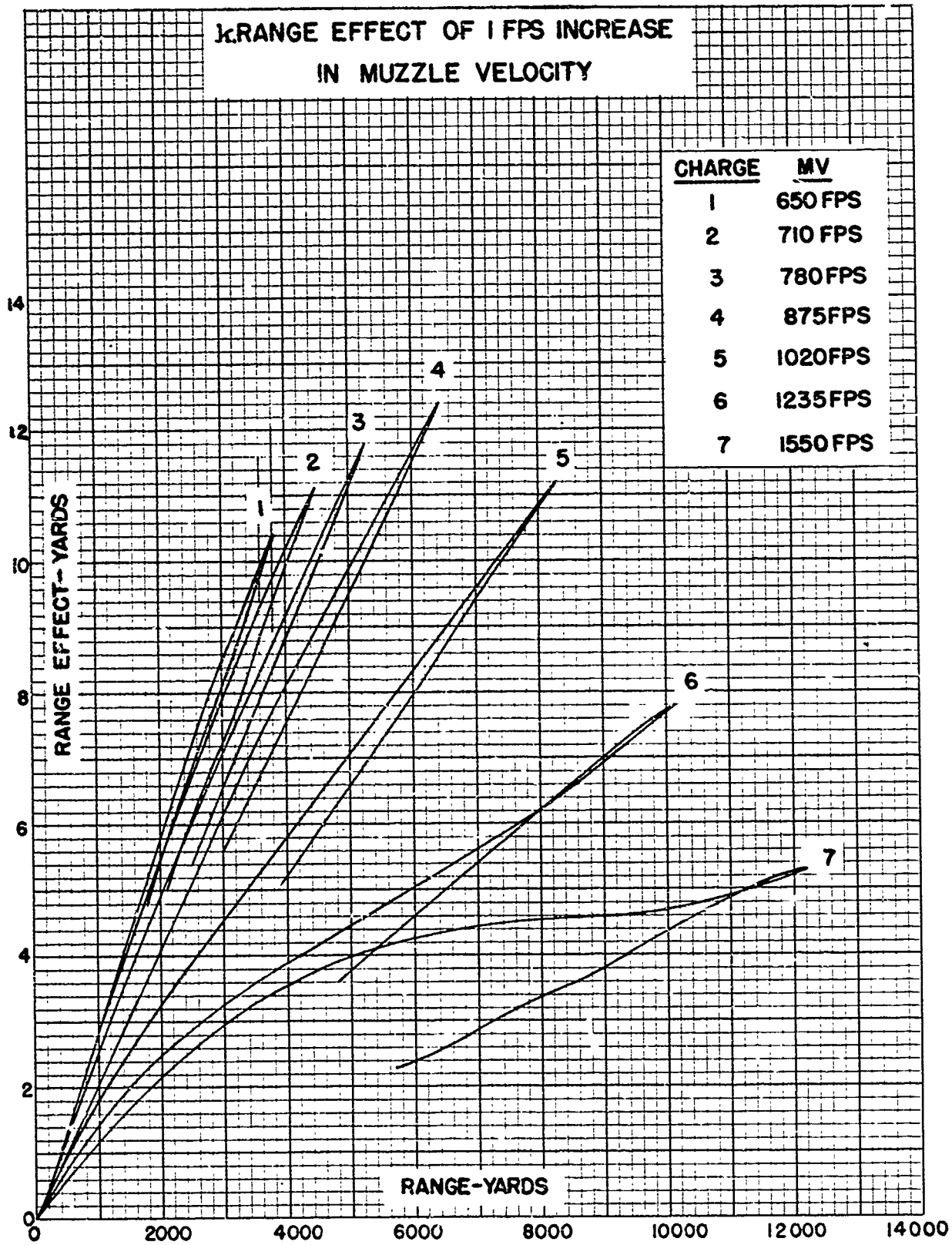

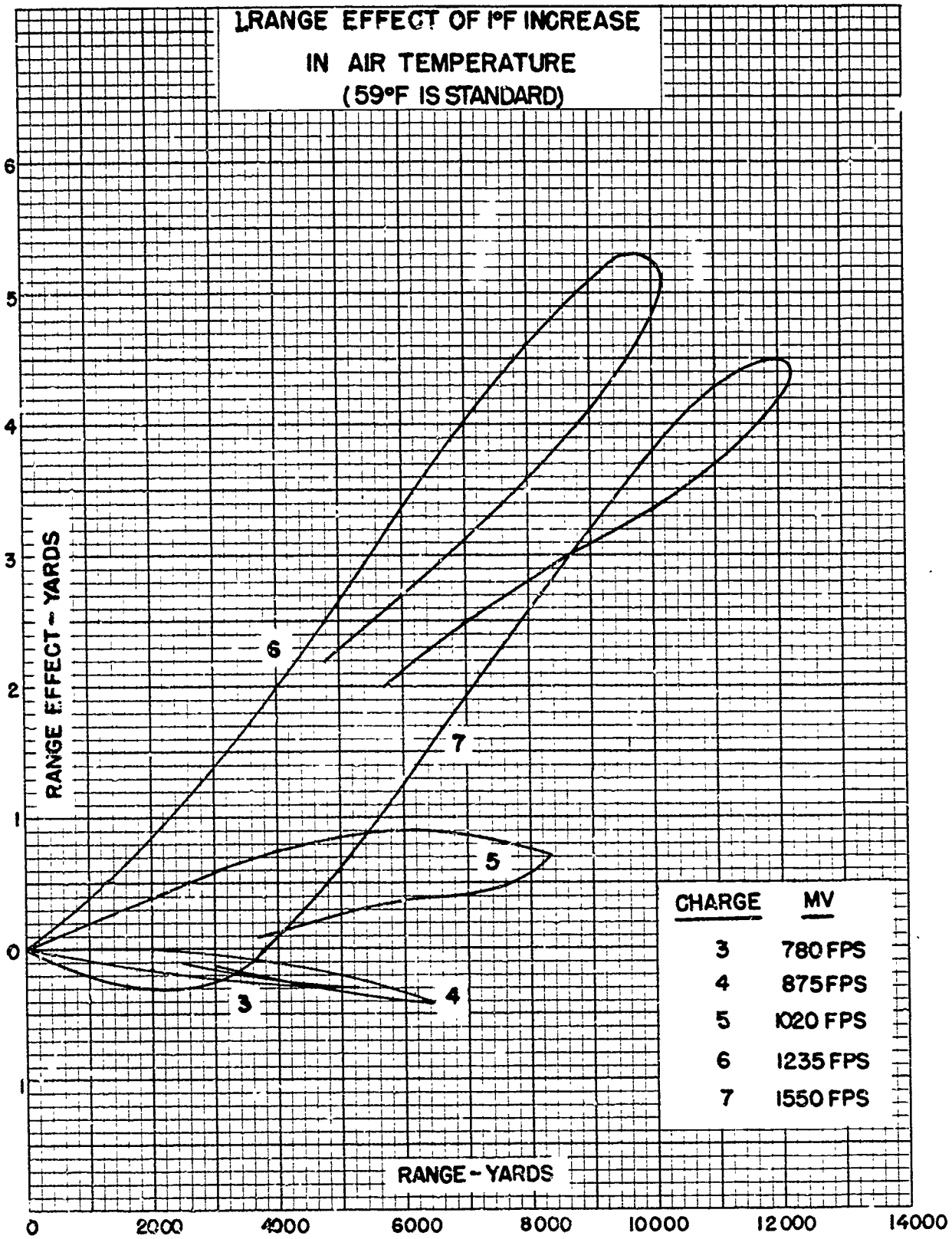

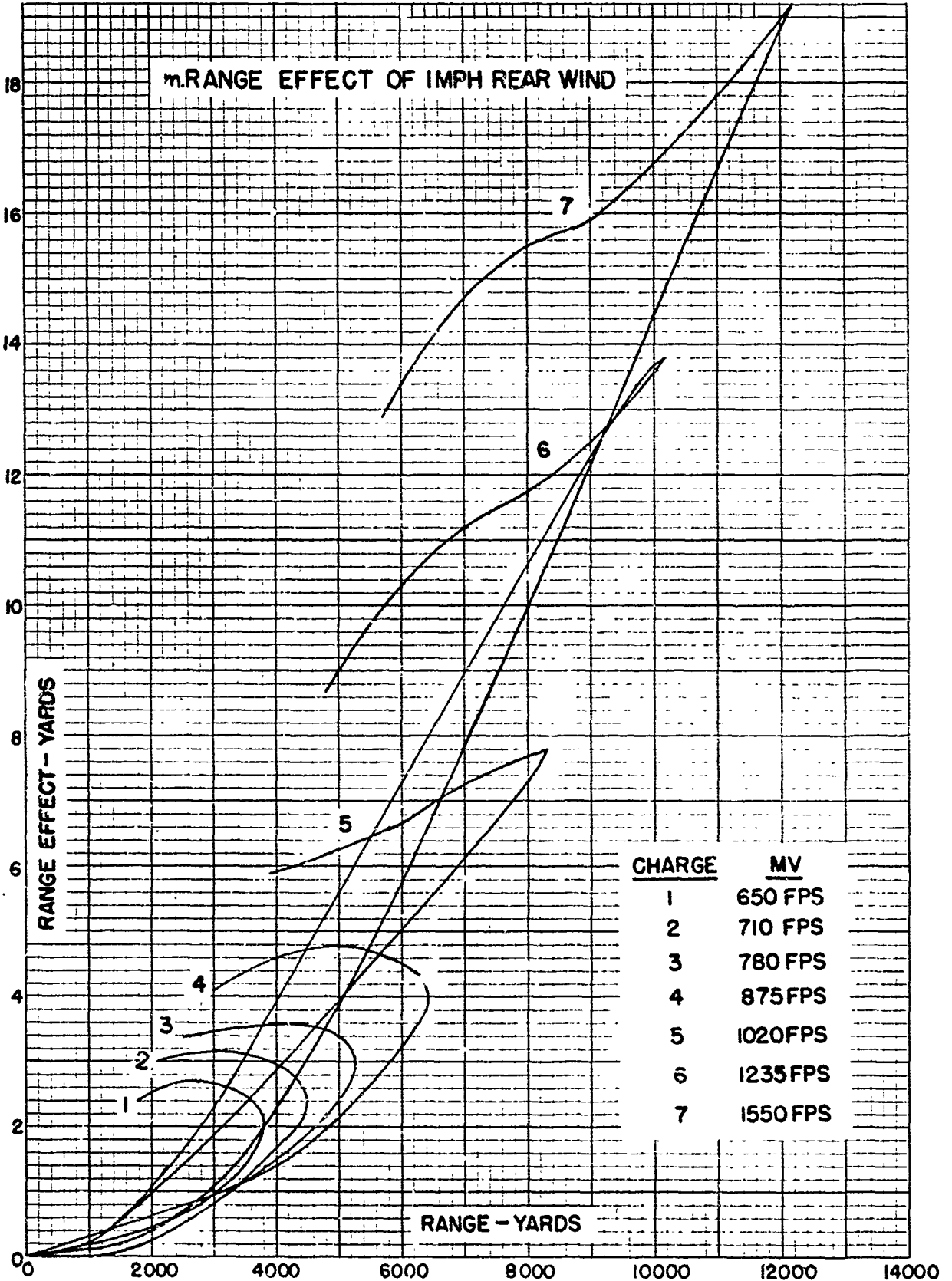

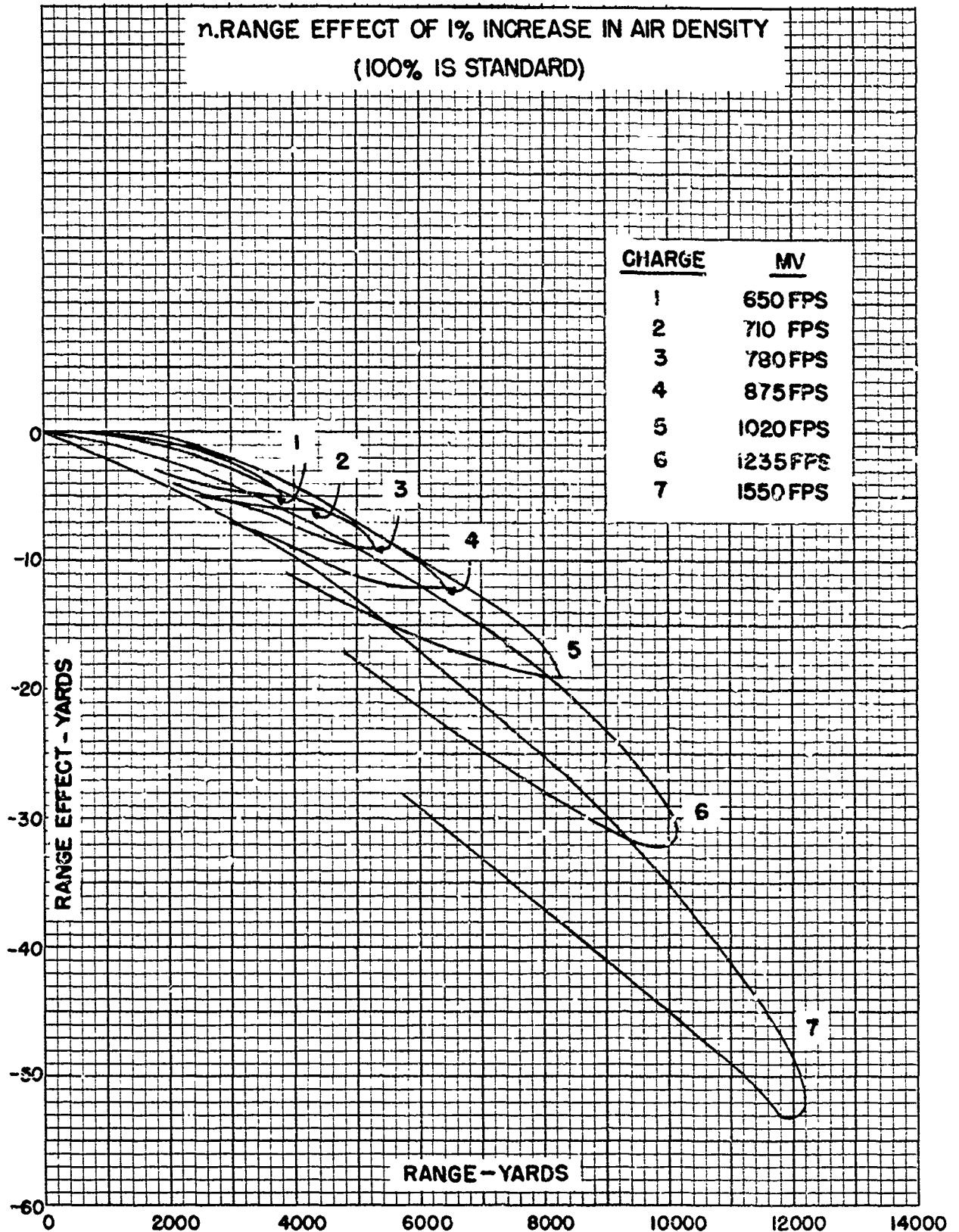

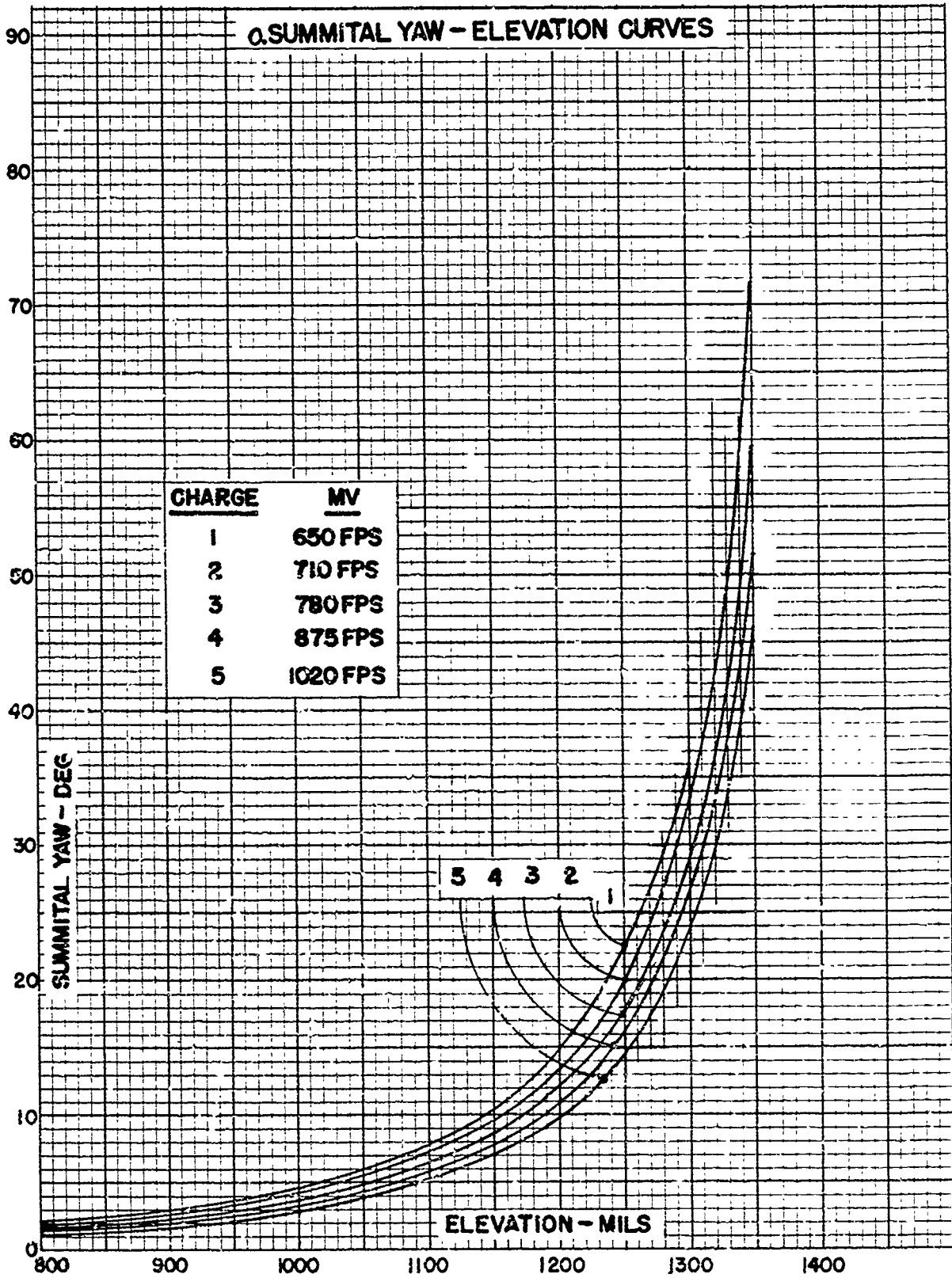

SECTION V
EFFECT DATA

	<u>Paragraph</u>
Fragmentation - - - - -	9
Effectiveness - - - - -	10
Ricochet data - - - - -	11
Penetration - - - - -	12

9. Fragmentation. The data on fragmentation of the 105-mm HE Shell M1 were taken from TM9-1907 "Ballistic Data, Performance of Ammunition" (Sep 1944) and Vol. III of "Terminal Ballistic Data" (Sep 1945). The initial fragment velocity is 3500 fps.

a. Casualties.

TABLE 48
CASUALTIES

Distance from burst (ft)	Total number of effective fragments	Average number of effective frag- ments per sq ft	For the lightest effective fragment	
			Weight (oz)	Velocity (fps)
r	N	B	m	v
20	1,160	0.231	0.010	2,440
30	1,115	0.0986	0.014	2,060
40	1,072	0.0533	0.019	1,770
60	996	0.0220	0.030	1,410
80	932	0.0220	0.030	1,410
100	875	0.0070	0.055	1,040
150	745	0.0026	0.083	846
200	642	0.0013	0.109	738
300	513	0.0004	0.166	598
400	423	0.0002	0.232	507
500	358	0.0001	0.312	438

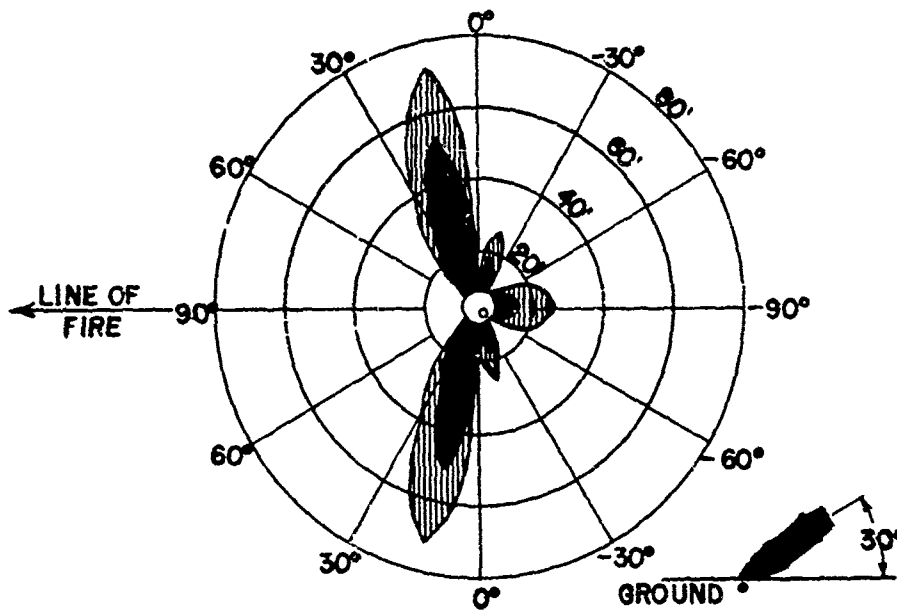
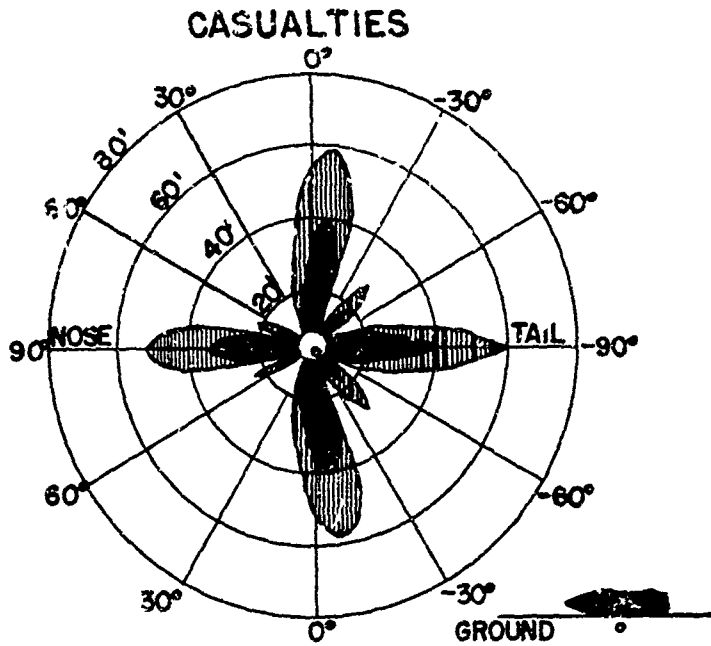



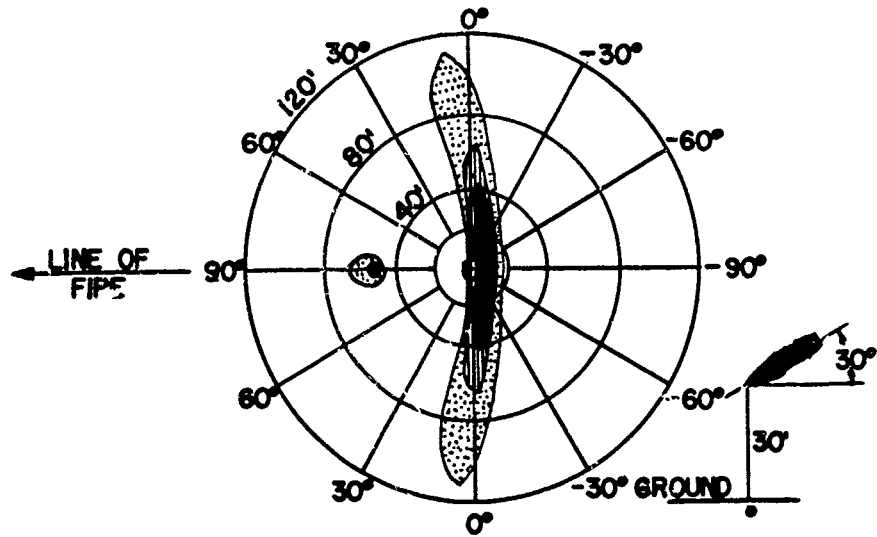

-
- AT LEAST 1 HIT PER 4 SQ FT HEIGHT OF BURST 0 FT
 AT LEAST 1 HIT PER 10 SQ FT REMAINING VELOCITY 800 FPS

CASUALTIES

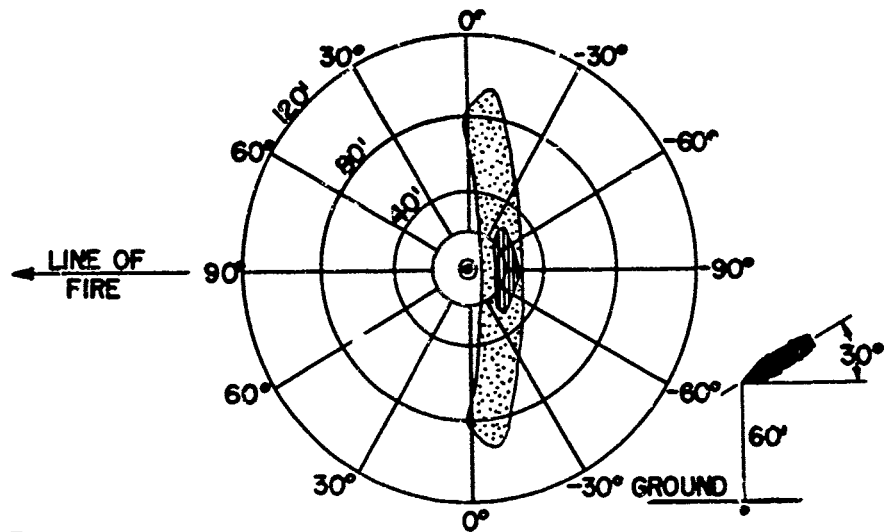

**INCLINATION 30°
HEIGHT OF BURST 30 FT
REMAINING VELOCITY 800FPS**



-  AT LEAST 1 HIT PER 4 SQ FT
-  AT LEAST 1 HIT PER 10 SQ FT
-  AT LEAST 1 HIT PER 25 SQ FT

**INCLINATION 30°
HEIGHT OF BURST 60 FT
REMAINING VELOCITY 800FPS**

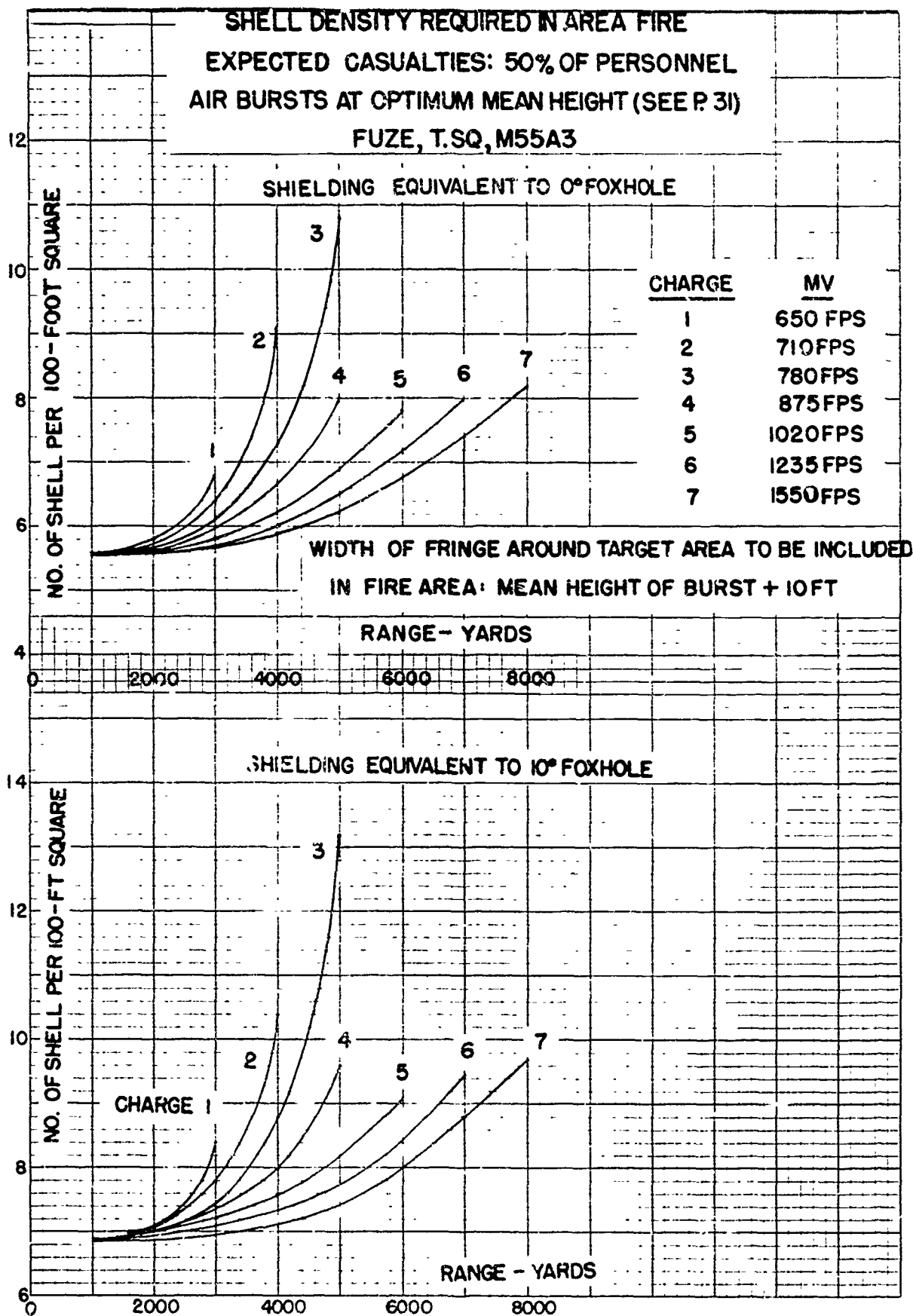

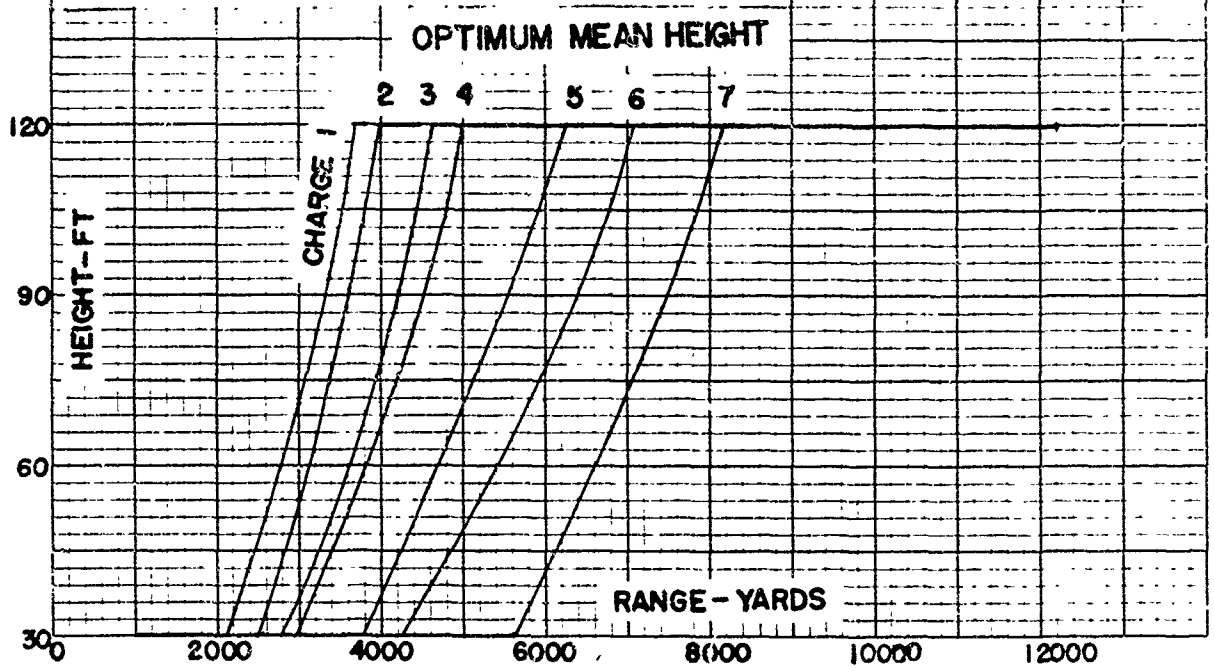
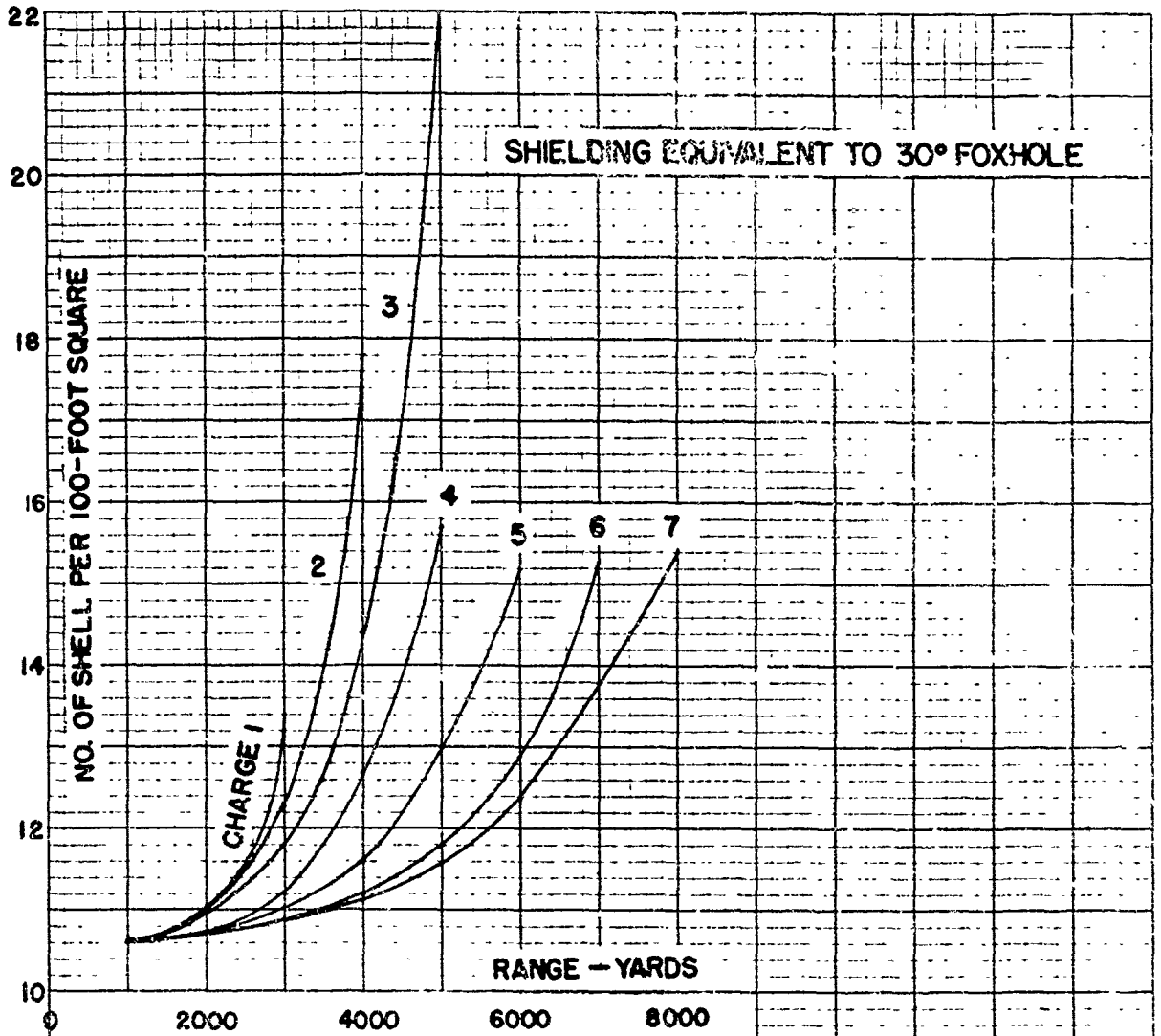

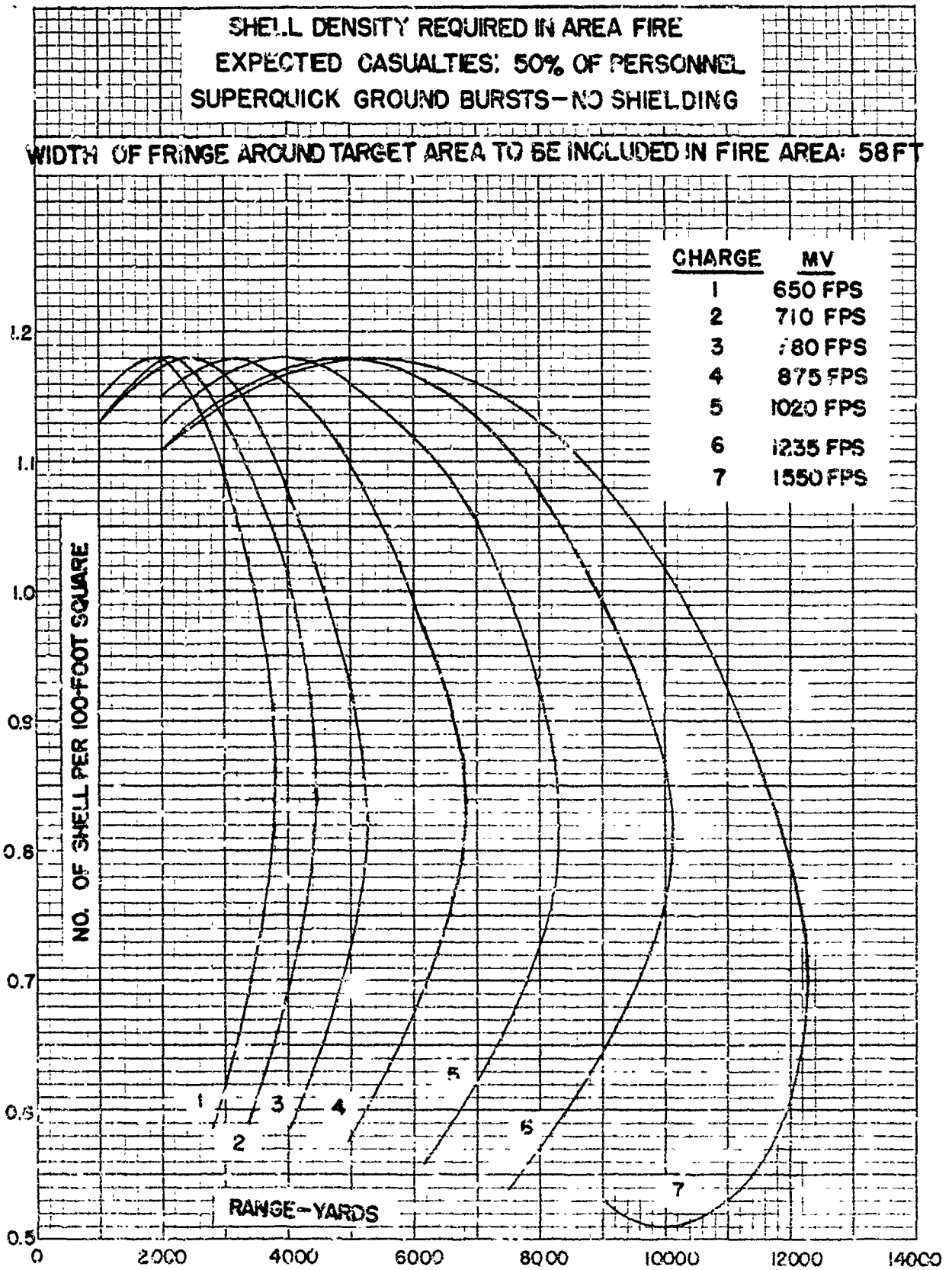

b. Perforation of 1/8-inch Mild Steel.

TABLE 49
PERFORATION OF 1/8 IN. MILD STEEL

Distance from burst (ft)	Total number of effective fragments	Average number of effective frag- ments per sq ft	For the lightest effective fragment	
			Weight (oz)	Velocity (fps)
r	N	B	m	v
20	975	0.194	0.035	2,700
30	923	0.0816	0.047	2,430
40	853	0.0424	0.061	2,220
60	700	0.0155	0.095	1,920
80	570	0.0071	0.137	1,750
100	470	0.0037	0.192	1,550
120	403	0.0022	0.255	1,420
140	341	0.0014	0.326	1,320
170	262	0.0007	0.448	1,200
200	210	0.0004	0.580	1,120
300	88	0.0001	1.05	955

PERFORATION OF 1/8-INCH MILD STEEL

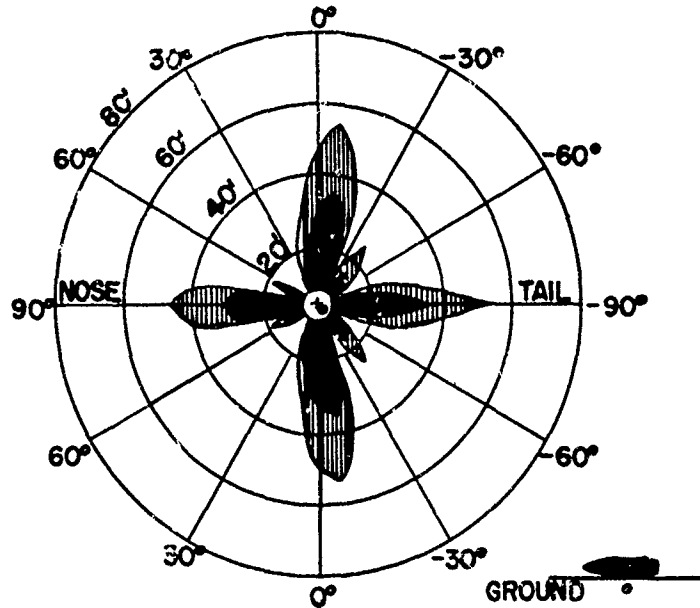

INCLINATION 0°
 HEIGHT OF BURST 0 FT
 REMAINING VELOCITY 0 FPS

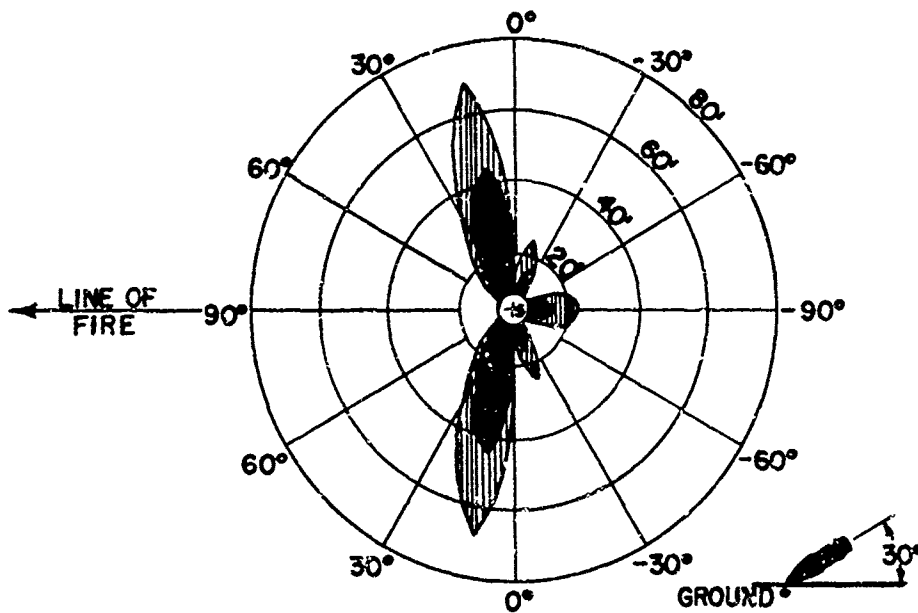

 AT LEAST 1 HIT PER 4 SQ FT
 AT LEAST 1 HIT PER 10 SQ FT

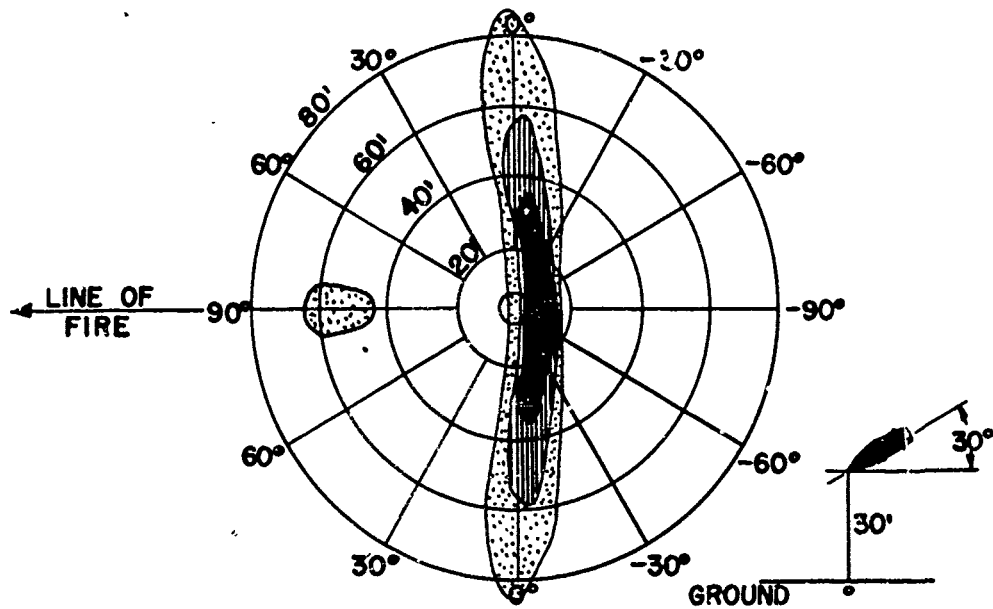

INCLINATION 30°
 HEIGHT OF BURST 0 FT
 REMAINING VELOCITY 800 FPS

PERFORATION OF 1/8-INCH MILD STEEL

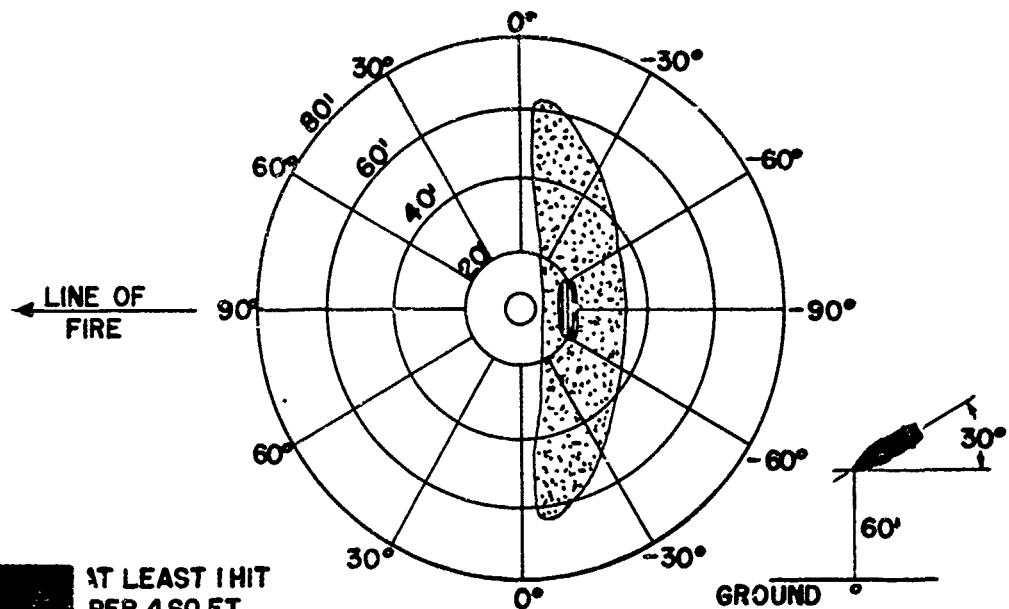

INCLINATION 30°
HEIGHT OF BURST 30 FT
REMAINING VELOCITY 800 FPS



-  AT LEAST 1 HIT PER 4 SQ FT
-  AT LEAST 1 HIT PER 10 SQ FT
-  AT LEAST 1 HIT PER 25 SQ FT

INCLINATION 30°
HEIGHT OF BURST 60 FT
REMAINING VELOCITY 800 FPS

**SHELL DENSITY REQUIRED IN AREA FIRE
EXPECTED PERFORATIONS OF 1/8-INCH MILD STEEL:
50% OF ELEMENTS 2 SQ FT IN AREA
SUPERQUICK GROUND BURSTS - NO SHIELDING**

**WIDTH OF FRINGE AROUND TARGET AREA
TO BE INCLUDED IN FIRE AREA: 29 FT**

<u>CHARGE</u>	<u>MV</u>
1	650 FPS
2	710 FPS
3	780 FPS
4	875 FPS
5	1020 FPS
6	1235 FPS
7	1550 FPS

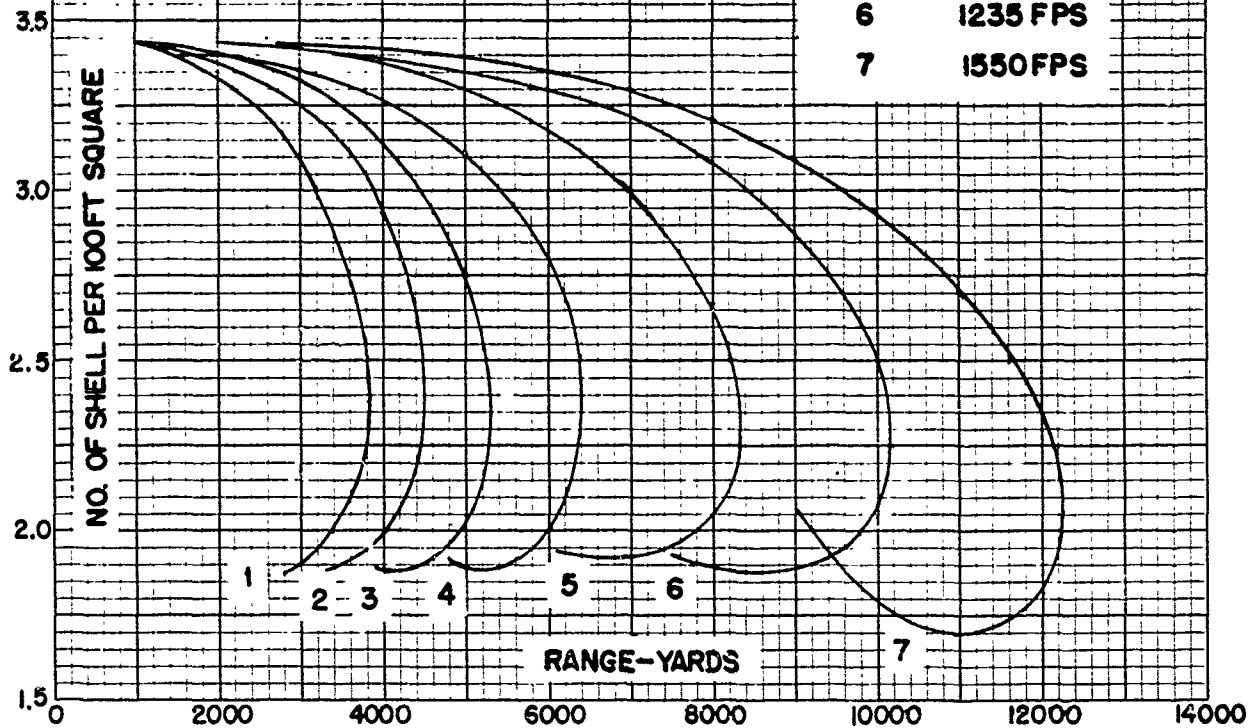

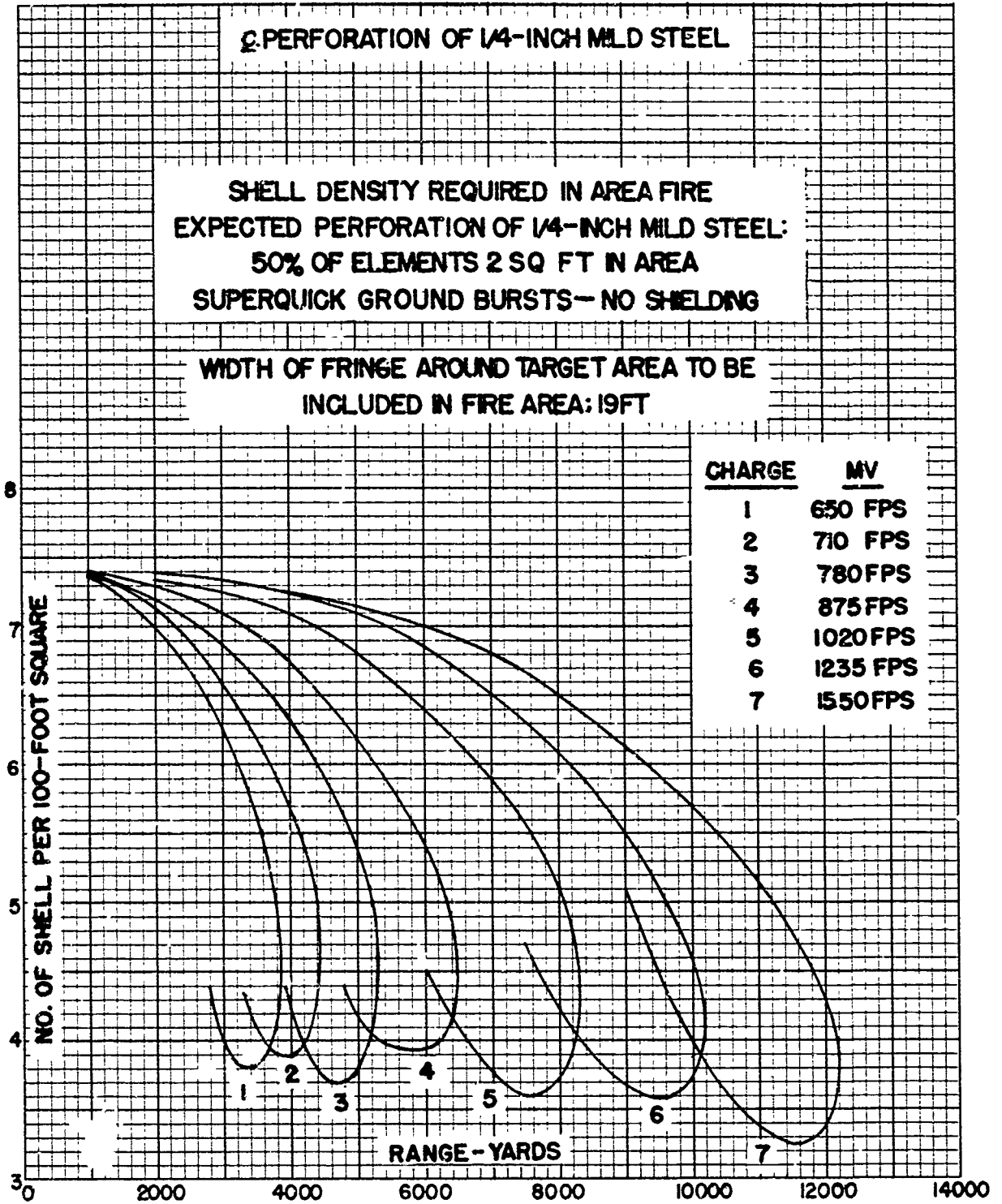

10. **Effectiveness.** The following data were taken from Vol. III of "Terminal Ballistic Data". They pertain to the 105-mm HE Shell M1 with a PD or TSQ Fuze.

NUMBER OF ROUNDS REQUIRED AGAINST ENEMY ARTILLERY FOR 90%
PROBABILITY OF AT LEAST ONE EFFECTIVE HIT IN AIMED FIRE

MV <u>fps</u>	Range <u>yd</u>	<u>Impact</u>	<u>Type of Fire</u>	
			<u>Time</u>	<u>Time and Impact</u>
1020	2000	24	250	41
	5000	460	820	430
1550	2000	6	270	13
	5000	91	450	130

11. **Ricochet Data.** The following data were taken from Vol. III of "Terminal Ballistic Data". They pertain to the 105-mm HE Shell M1 with the PD Fuzes M48A2 and M51A4, which have 0.15-sec delay.

TABLE 77

	Range	Angle of	Angle of	Impact	Height	PE in
	yd	Fall mils	Recovery mils	to Burst yd	of Burst ft	Height of Burst ft
Charge 1						
MV 650 fps	1,000	126	170	24	12	2
	2,000	272	285	15	13	3
Charge 2						
MV 710 fps	1,000	104	145	27	12	2
	2,000	226	260	19	15	3
	3,000	376	315	10	10	3
Charge 3						
MV 780 fps	1,000	87	125	31	12	2
	2,000	188	230	23	16	3
	3,000	304	295	15	14	3
Charge 4						
MV 875 fps	1,000	68	105	36	11	2
	2,000	147	195	29	17	3
	3,000	237	265	21	17	4
	4,000	343	305	14	13	3
Charge 5						
MV 1,020 fps	1,000	51	80	44	10	2
	2,000	109	155	37	17	3
	3,000	174	220	30	20	4
	4,000	247	270	23	19	4
	5,000	331	305	17	15	4
	6,000	430	315	10	9	3
Charge 6						
MV 1,235 fps	1,000	39	65	51	10	2
	2,000	86	125	43	17	3
	3,000	138	185	36	20	4
	4,000	198	235	30	21	4
	5,000	265	280	24	20	4
	6,000	339	305	17	16	4
	7,000	422	315	10	10	4
Charge 7						
MV 1,500 fps	1,000	25	45	65	8	2
	2,000	60	95	54	15	3
	3,000	104	145	44	19	4
	4,000	156	200	37	22	4
	5,000	214	250	29	22	5
	6,000	278	285	23	20	5
	7,000	348	310	17	16	4
	8,000	423	315	10	10	4

12. Penetration. The data on penetration of concrete by the HE Shell M1 with the CP Fuze M78 were taken from TM9-1907, "Ballistic Data, Performance of Ammunition". The data on penetration into medium earth and logs by the HE Shell M1 with any DP or CP fuze were taken from Vol. III of "Terminal Ballistic Data".

**a. TOTAL NUMBER OF ROUNDS NECESSARY TO OBTAIN
90% PROBABILITY OF AT LEAST ONE PERFORATION IN
TARGETS OF GRADE A CONCRETE (5000 PSI)
MV 1550 FPS**

GRAPH	TARGET DIMENSIONS-FT		
	THICKNESS	HEIGHT	WIDTH
A	7	10	15 TO 30
B	5	4.5	7.5
C	5	10	15 TO 30
D	3	4.5	7.5

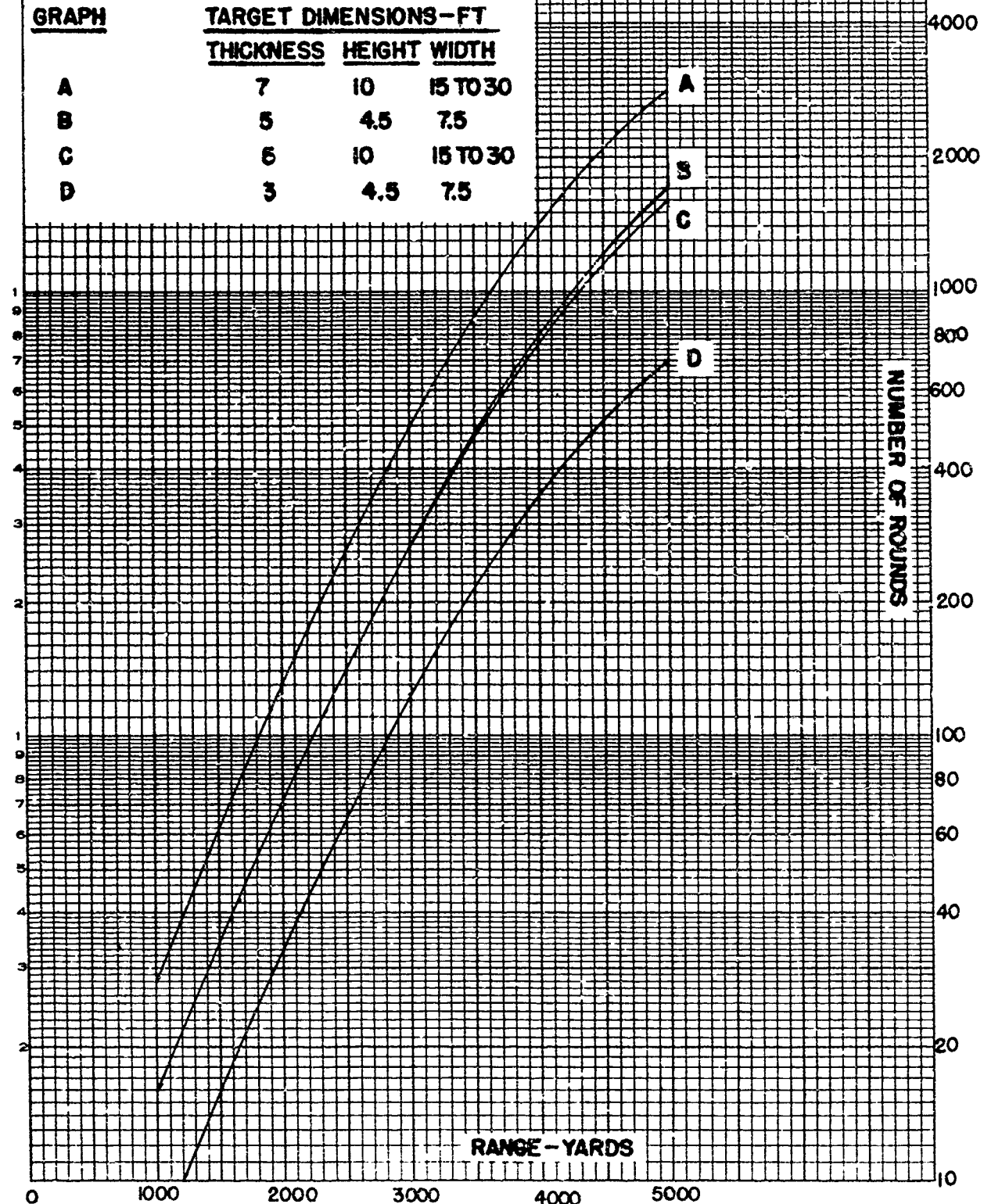

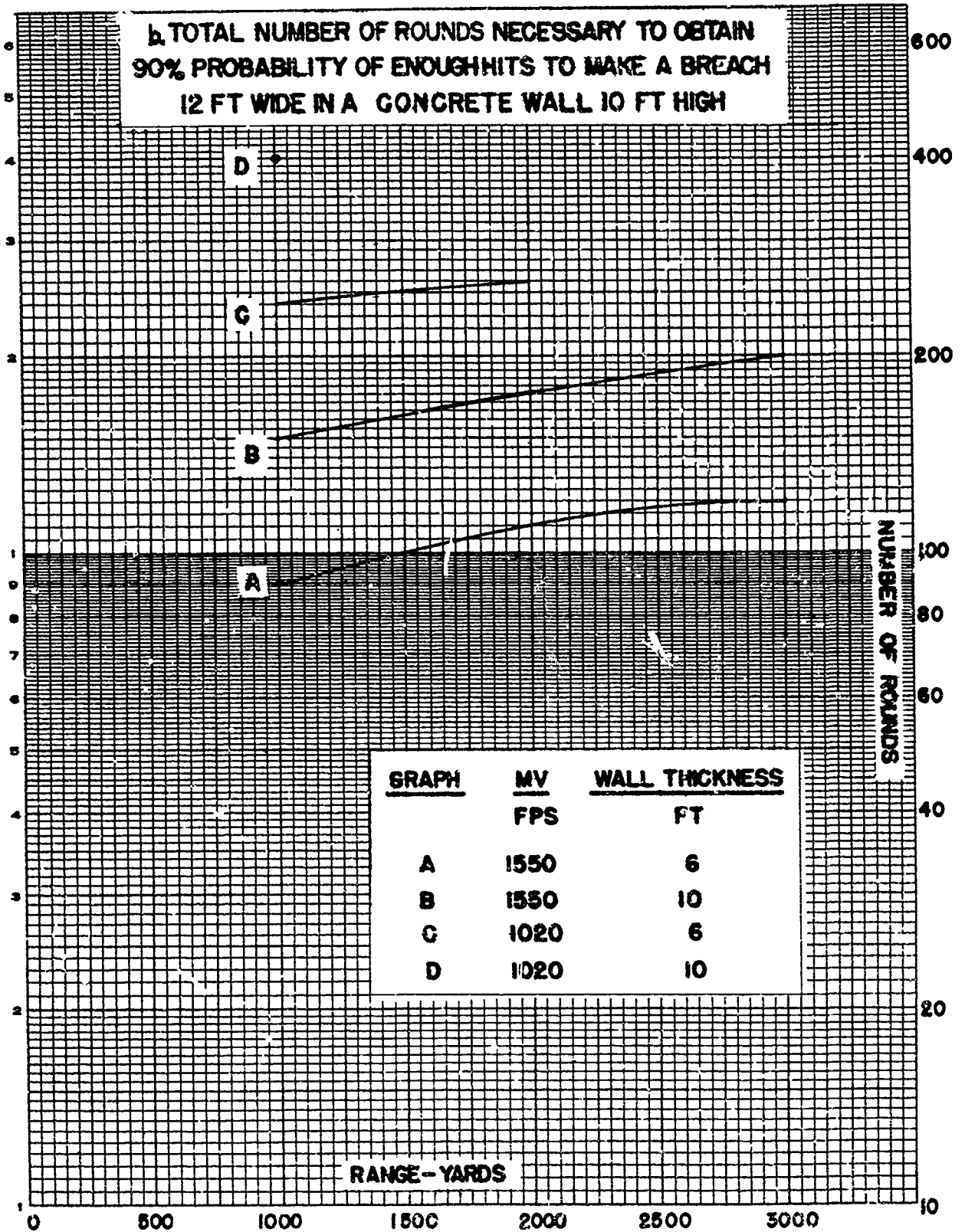

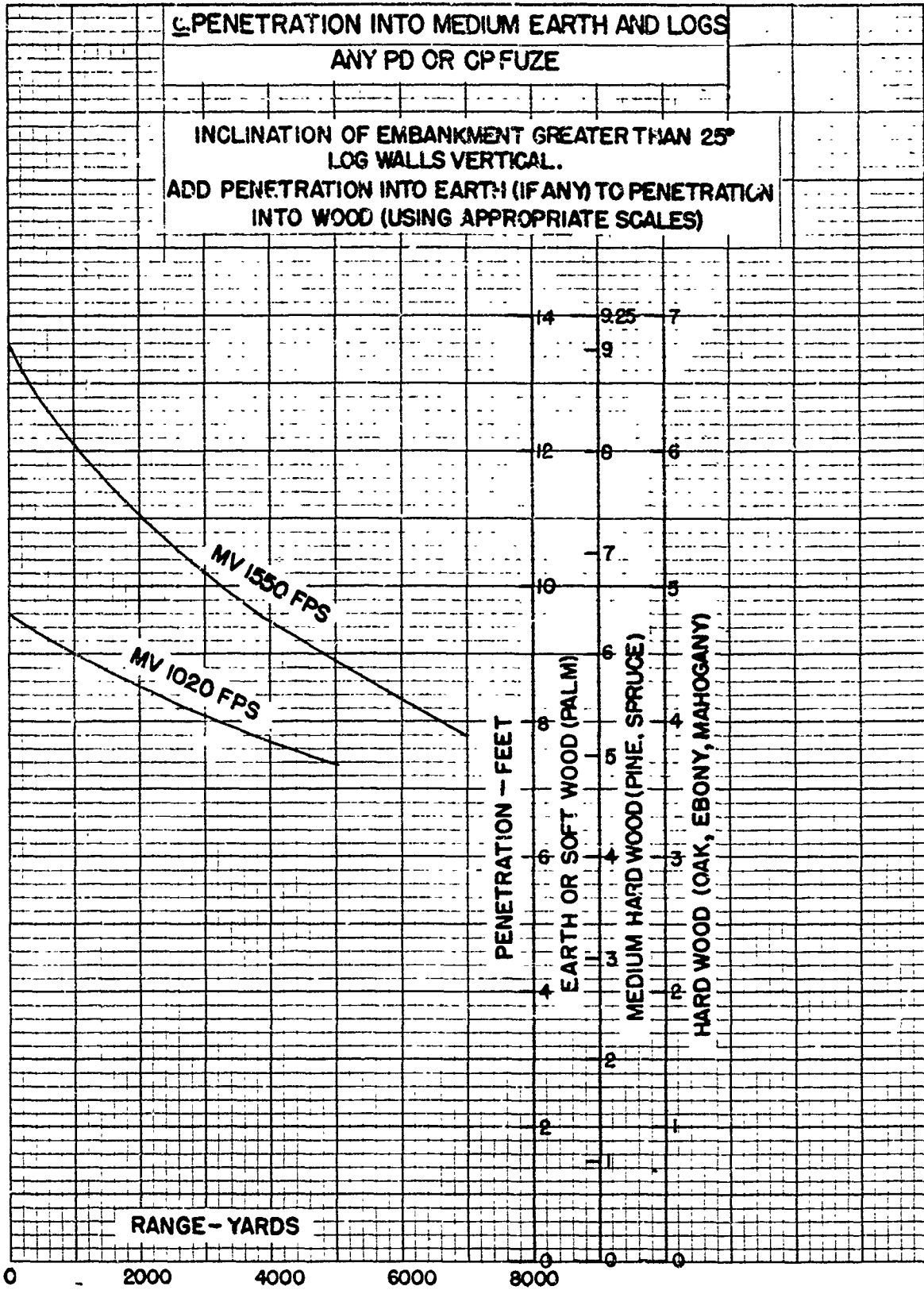

Ballistic Research Laboratories
Handbook of Ballistic and
Engineering Data for Ammunition,
No. 105-1-T12

Ballistic Research Lab.
Aberdeen Proving Ground,
Maryland.
15 February 1949

BALLISTIC AND ENGINEERING DATA

for

Shell, HE, 105-mm, T12

with

Fuze, MT, M61A1

<u>Section</u>		<u>Paragraphs</u>
I	General -----	1
II	Description -----	2 - 4
III	Interior ballistic data -----	5
IV	Exterior ballistic data-----	6

SECTION I

GENERAL

	<u>Paragraph</u>
Purpose - - - - -	1

1. **Purpose.** The purpose of this number of the handbook is to furnish a concise collection of information regarding the shape, dynamics and ballistics of the 105-mm High Explosive Shell T12 with the Mechanical Time Fuze M61A1. This information is collected from the drawings, reports and firing tables pertaining to this ammunition.

ALL DIMENSIONS IN CALIBERS
1 CAL = 4.134"

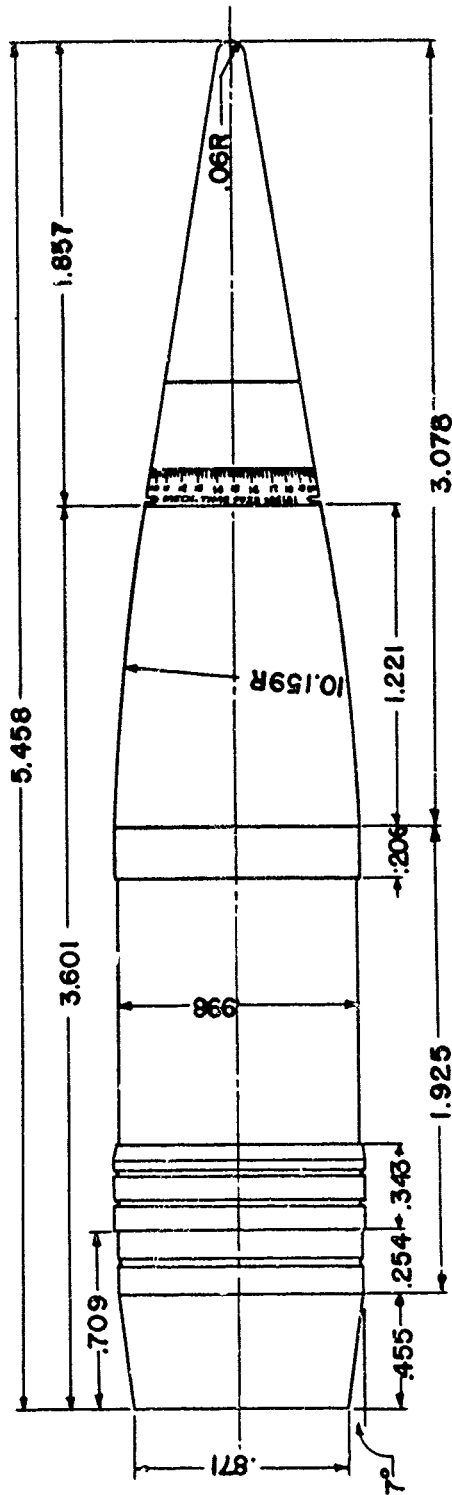

SHELL, HE, 105-MM, T12
FUZE, MT, M61A1

**SECTION II
DESCRIPTION**

	<u>Paragraph</u>
Drawings - - - - -	2
Dimensions - - - - -	3
Physical characteristics - - - - -	4

2. Drawings.

Shell: Metal parts assembly and details	GA 2127
Fuze: Assembly	73-7-71
Details	73-7-72, 74,75,76

3. Dimensions.

Boattail: Angle	7°00'
Length	0.455 cal
Band: Width	0.343 cal
Distance from base	0.709 cal
Distance from boattail	0.254 cal
Cylindrical body: Length	1.925 cal
Ogive: Length	1.221 cal
Radius of arc	10.159 cal
Fuze: Outside length	1.857 cal
Length: Shell	2.601 cal
Shell and fuze	5.458 cal
Ogive and fuze	3.078 cal

4. Physical characteristics.

Mean weight	38 lb
-------------	-------

**SECTION III
INTERIOR BALLISTIC DATA**

	<u>Paragraph</u>
Theoretical yaw in bore - - - - -	5

5. Theoretical yaw in bore.

Minimum	2.7 min
Maximum	5.0 min

SECTION IV
EXTERIOR BALLISTIC DATA

Cam data - - - - - Paragraph
6

6. Cam data.

Gun, 105-mm, T4 on antiaircraft mount.
Twist of rifling: 1/30.
Muzzle velocity: 3000 fpr.
Projectile weight: 28 lb.

a. Form factor (Proj Type 2): $i_2 = 0.882$.

b. Ballistic coefficient (Proj Type 2): $C_2 = 2.52$.

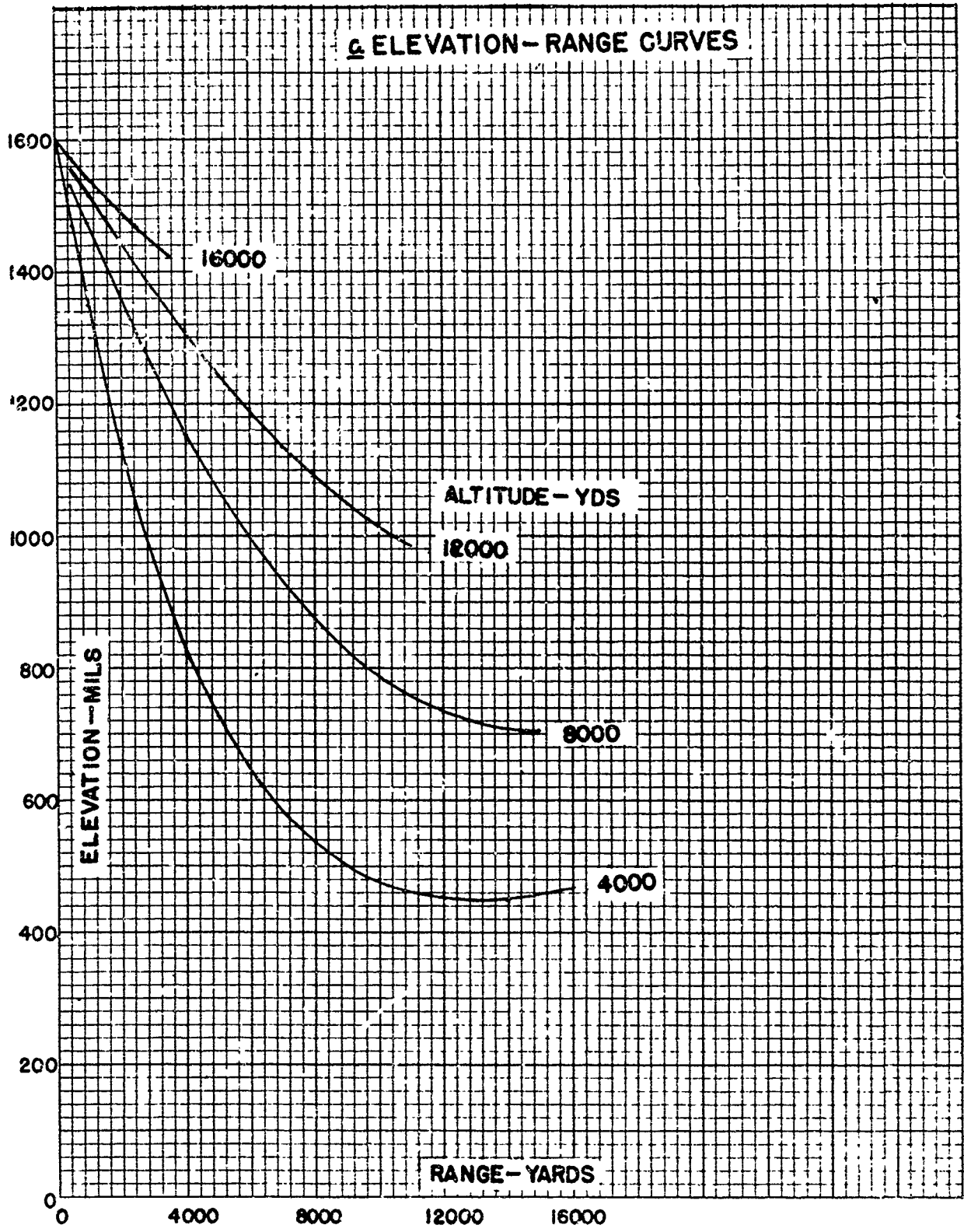

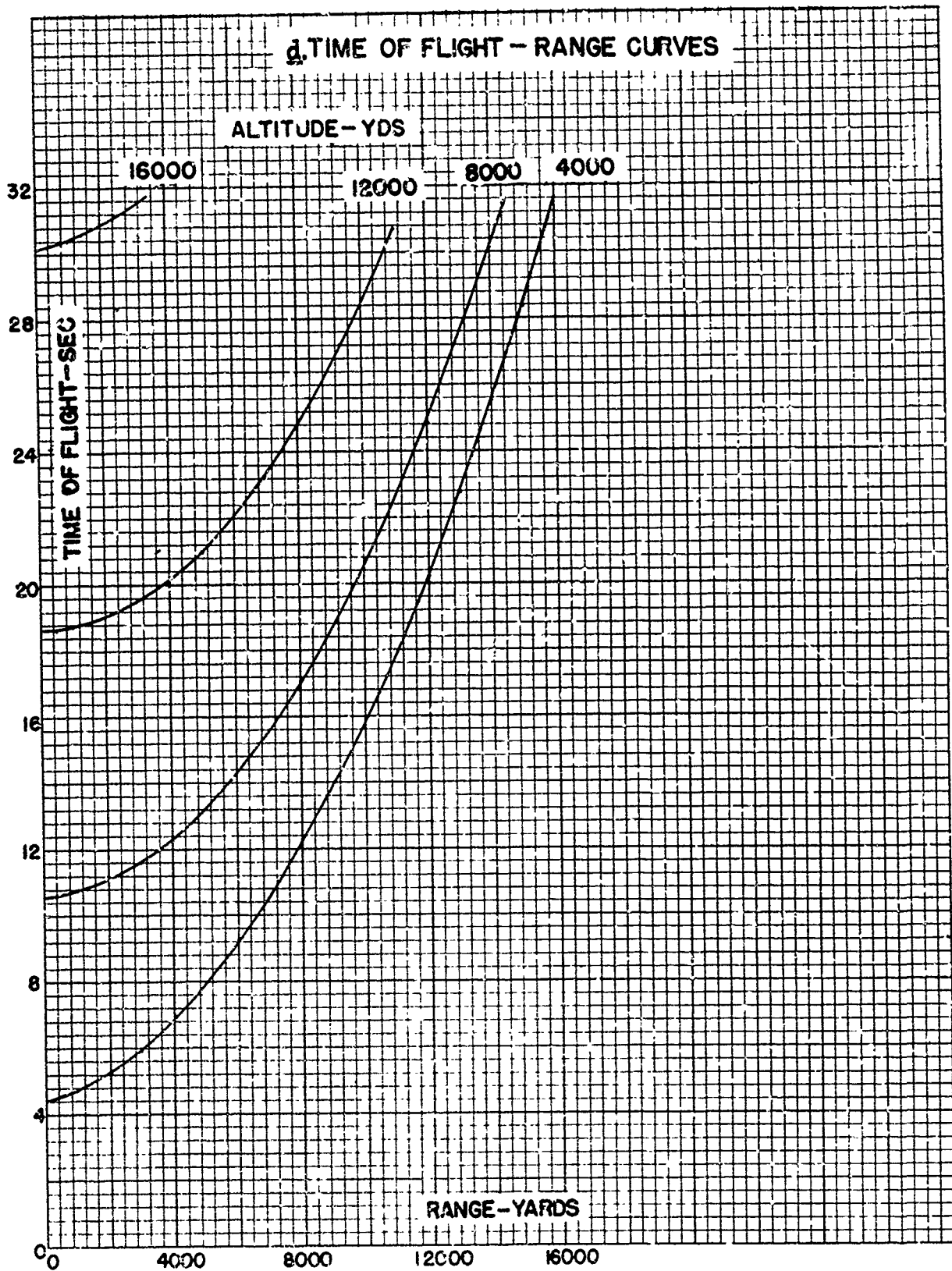

Ballistic Research Laboratories
 Handbook of Ballistic and
 Engineering Data for Ammunition,
 No. 105-1-67

Ballistic Research Lab.
 Aberdeen Proving Ground,
 Maryland
 14 February 1949

BALLISTIC AND ENGINEERING DATA
 for
 Shell, HEAT, 105-mm, M67
 with
 Fuze, BD, M62

<u>Section</u>		<u>Paragraphs</u>
I	General-----	1
II	Description -----	2 - 4
III	Interior ballistic data -----	5 - 6
IV	Exterior ballistic data -----	7 - 8
V	Effect data -----	9

**SECTION I
 GENERAL**

	<u>Paragraph</u>
Purpose - - - - -	1

1. **Purpose.** The purpose of this number of the handbook is to furnish a concise collection of information regarding the shape, dynamics, ballistics and effects of the 105-mm High Explosive Antitank Shell M67 with the Base Detonating Fuze M62. This information is collected from the drawings, reports, and firing tables pertaining to this ammunition.

**SECTION II
 DESCRIPTION**

	<u>Paragraph</u>
Drawings - - - - -	2
Dimensions - - - - -	3
Physical characteristics - - - - -	4

ALL DIMENSIONS IN CALIBERS
1 CALIBER = 4.134"

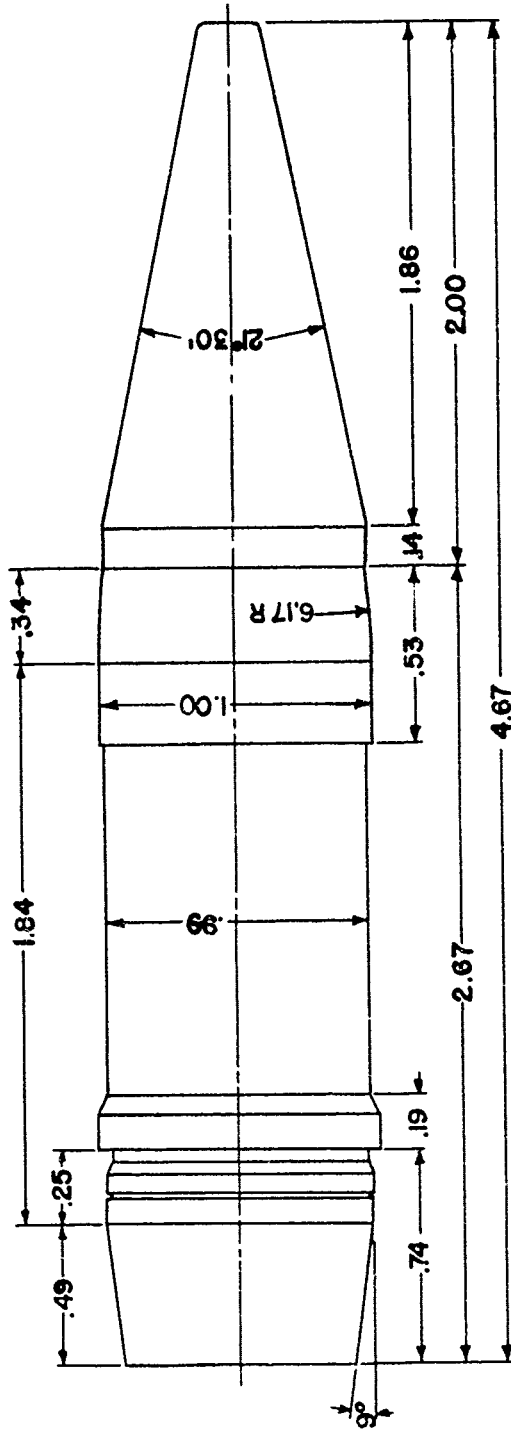

SHELL, HEAT, 105-MM, M67

2. Drawings.

Shell: Assembly	75-14-352
Metal parts details	75-4-106
Ogive and union assembly	75-4-107
Fuze: Assembly	73-2-168
Details	73-2-169
Details	73-2-170
Details	73-2-171

3. Dimensions.

Boattail: Angle	9°00'
Length	0.49 cal
Band: Distance from boattail	0.25 cal
Distance from base	0.74 cal
Width	0.19 cal
Body: Length of cylindrical part	1.84 cal
Length of ogival part	0.34 cal
Radius of arc	6.17 cal
Union: Length	0.14 cal
Ogive: Length	1.86 cal
Angle	21°30'
Length: Body	2.67 cal
Ogive and union	2.00 cal
Shell	4.67 cal
Ogive, union and ogival part of body	2.34 cal

NOTE: Fuze is entirely inside of shell body.

4. Physical characteristics.

Weight (standard)	29.29 lb
Base to center of gravity	1.497 cal
Axial moment of inertia	0.515 lb.ft ²
Transverse moment of inertia	4.18 lb.ft ²

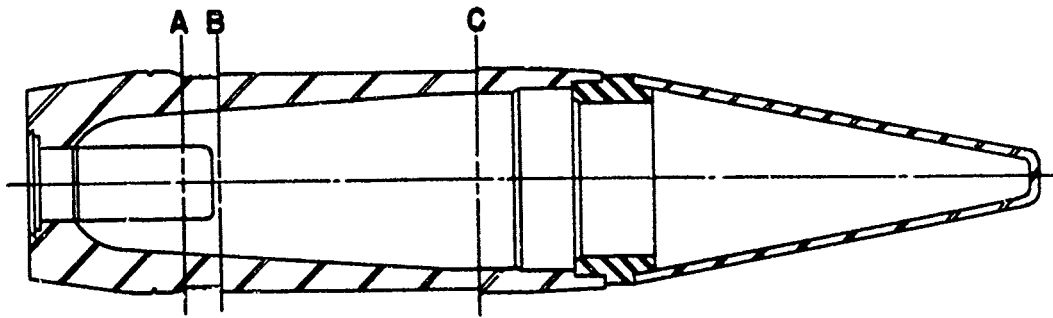

SECTIONS

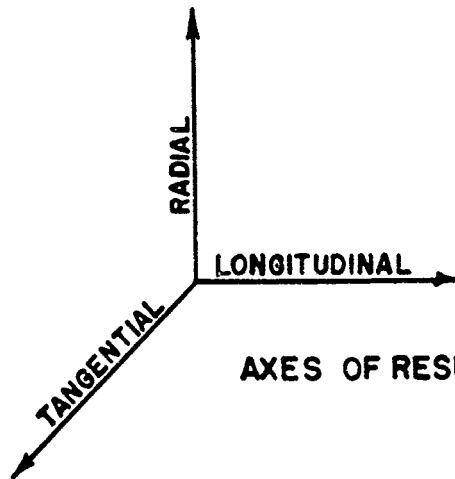
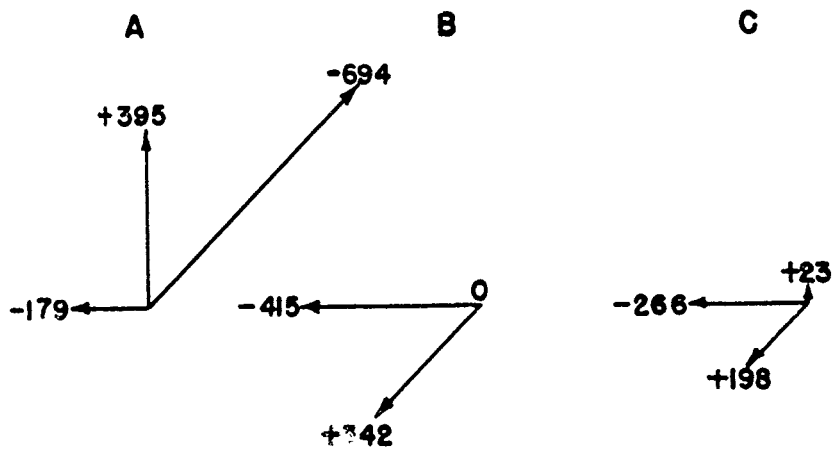

AXES OF RESULTANT STRESSES

DIAGRAM OF RESULTANT STRESSES

SECTION III
INTERIOR BALLISTIC DATA

	<u>Paragraph</u>
Stresses - - - - -	5
Theoretical yaw in bore - - - - -	6

5. Stresses. The following table and the graphical representation on page 4 show the longitudinal, radial and tangential resultant stresses at each of three sections: (A) the rear corner of the band seat, (B) the front of the band seat, and (C) immediately behind the bourrelet.

Howitzer	105-mm M2
Twist of rifling	1/20
Cross-sectional area of bore	13.85 sq in.
Rated maximum pressure	30,000 psi
Total weight of projectile	29.29 lb
Muzzle Velocity	1250 fps
Density of filler (pentolite)	0.0574 lb per cu in.

<u>Resultant Stress*</u>	<u>SECTION</u>			
	100 psi	A	B	C
Longitudinal		-179	-415	-266
Radial		+395	0	+ 23
Tangential		-694	+342	+198

* + denotes tension, - denotes compression.

6. Theoretical yaw in bore.

Minimum	2.7 min
Maximum	5.0 min

SECTION IV
EXTERIOR BALLISTIC DATA

	<u>Paragraph</u>
Aerodynamic data - - - - -	7
Firing table data - - - - -	8

7. Aerodynamic data.

a. **Drag.** A form factor of 1.28 relative to the G_2 drag function was determined from resistance firings at 1250 fps with short coil distances. Later, more accurate measurements were made, and a form factor of 1.06 determined by resistance firings at both 1020 and 1250 fps. This value has been confirmed by comparative firings with the HEAT Shell M67 and the HE Shell M1 against a vertical target at a muzzle velocity of 1020 fps. For the standard weight of 29.29 lb, the ballistic coefficient is 1.62 on G_2 . The drag coefficient is tabulated below.

<u>Velocity</u> fps	<u>Drag Coefficient</u> K_D
1020	.078b
1250	.170

b. **Stability.** The stability factor of the HEAT Shell M67 has not been determined. However, it should be approximately the same as that of the 75-mm HEAT Shell M66, which is about 2.07 for a twist of rifling of 1/20 at a muzzle velocity of 1000 fps.

8. Firing table data.

<u>Howitzer</u> <u>105-mm</u>	<u>Firing</u> <u>Table</u>	<u>MV</u> <u>fps</u>	<u>Weight</u> <u>lb</u>	<u>Twist of</u> <u>Rifling</u>
M2A1	105-H-3, C8	1250	28.8	1/20
M3	105-L-1	1020	28.8	1/20

The terminal velocity was taken from Ballistic Research Laboratory Memorandum Report 296, "Tables of Impact Velocities for Mobile Artillery Weapons". The HEAT Shell M67 was standardized by OCM item 17639.

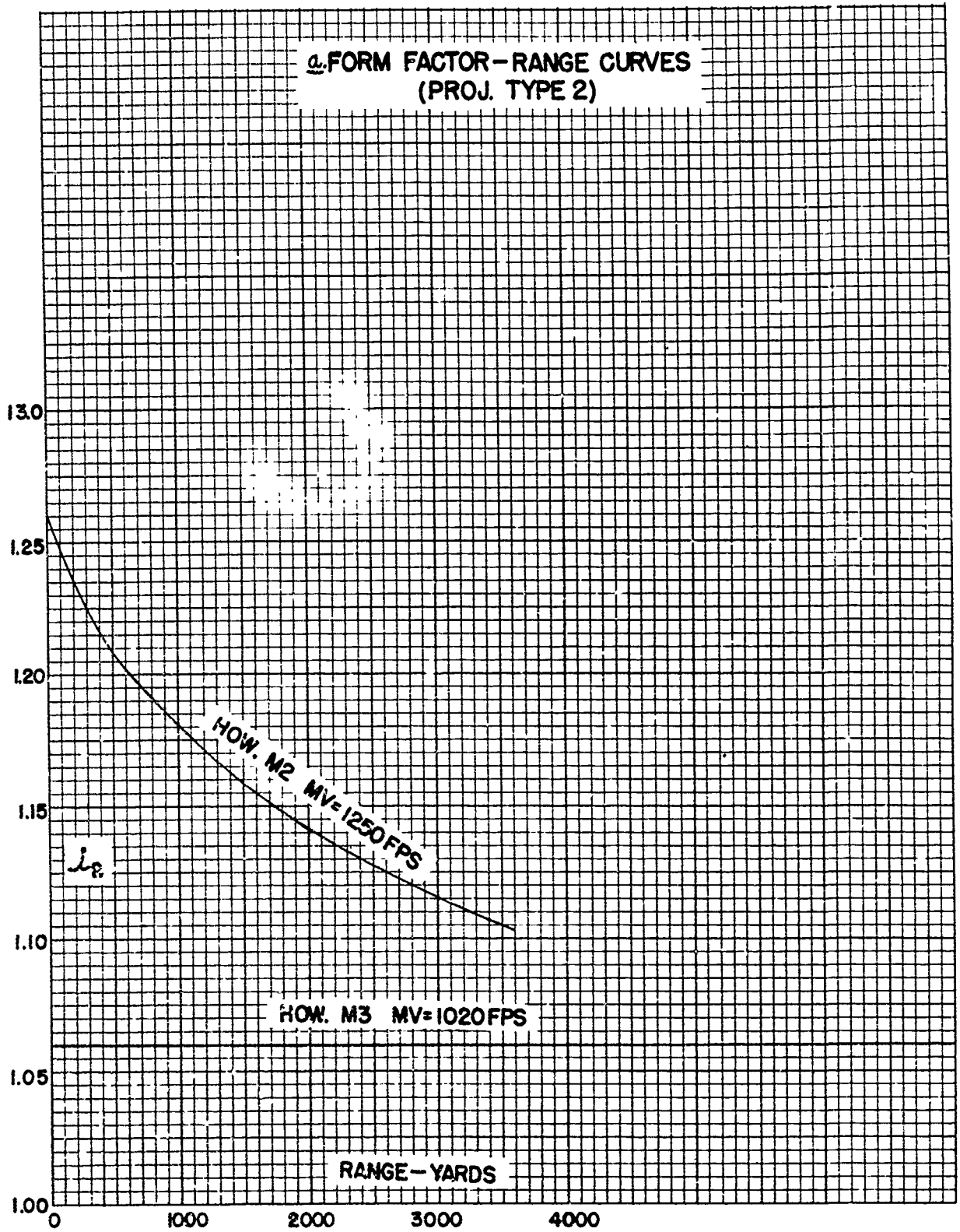

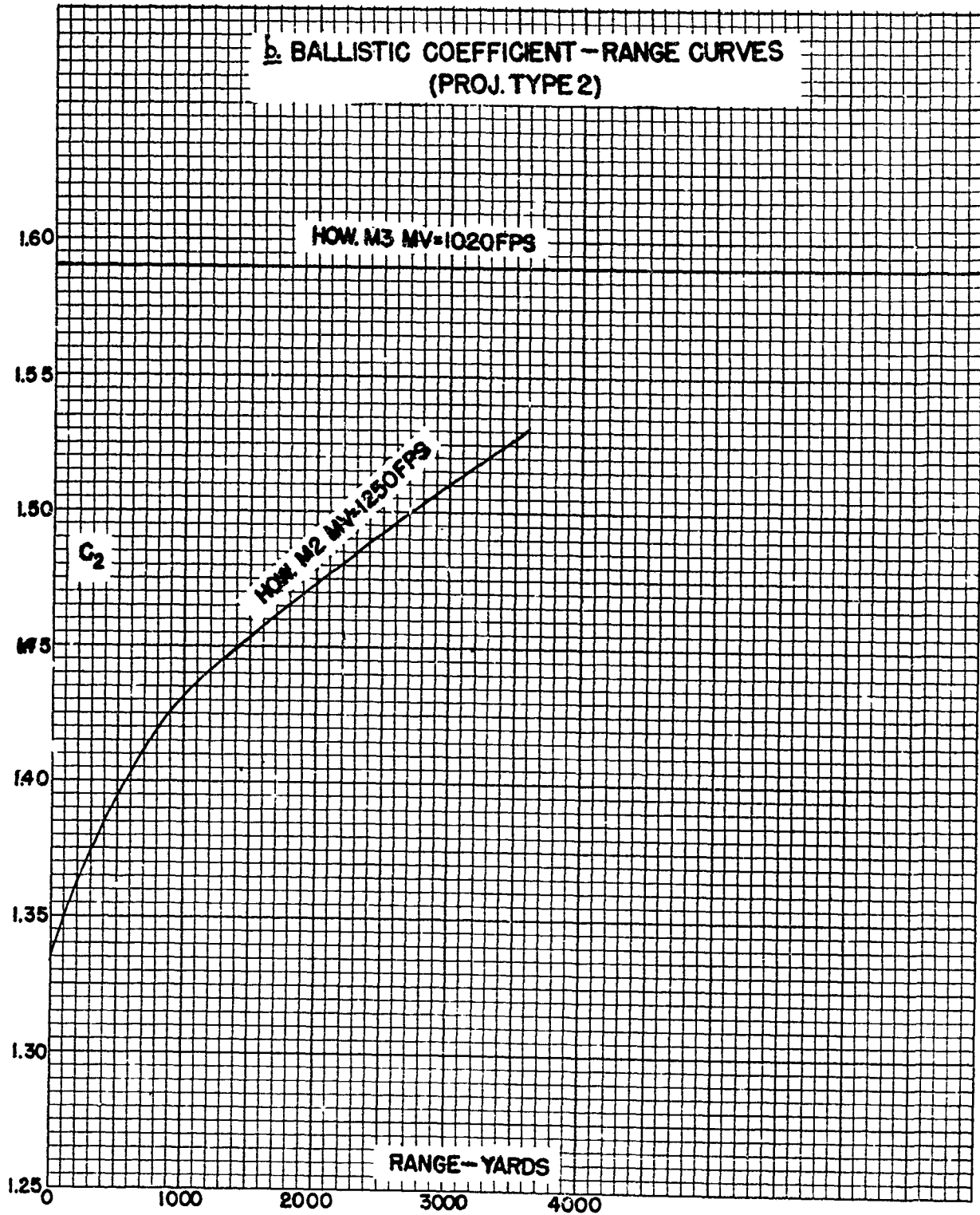

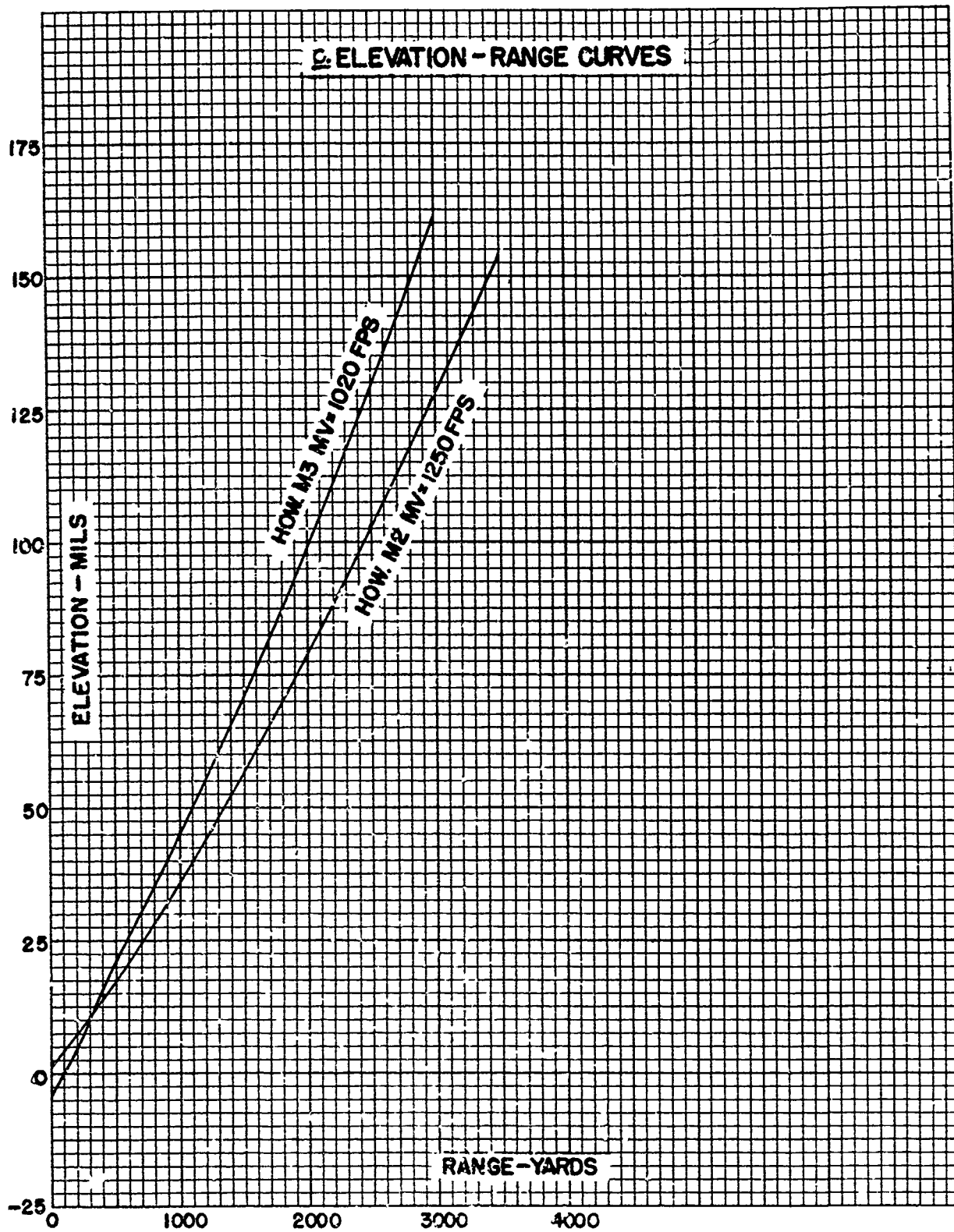

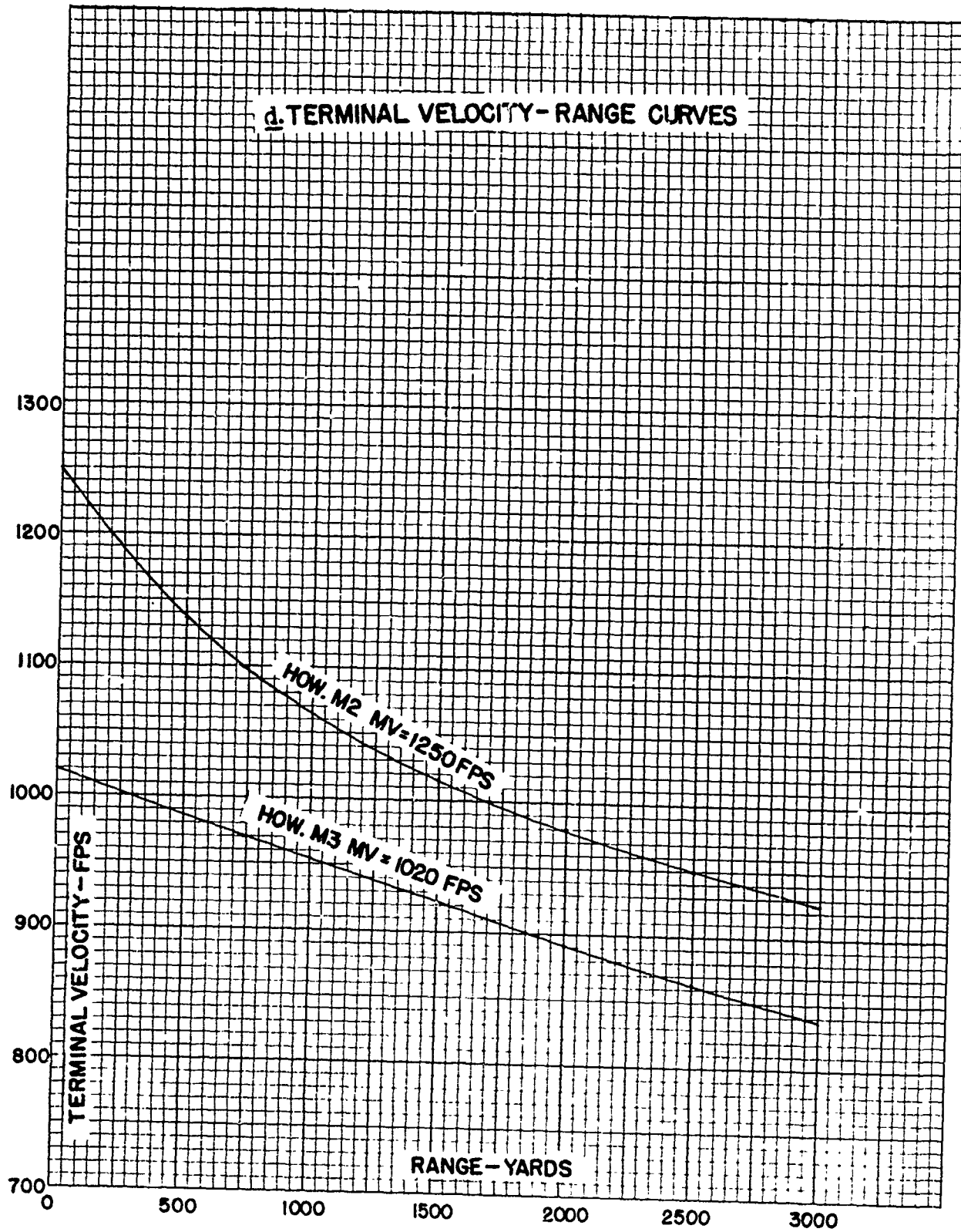

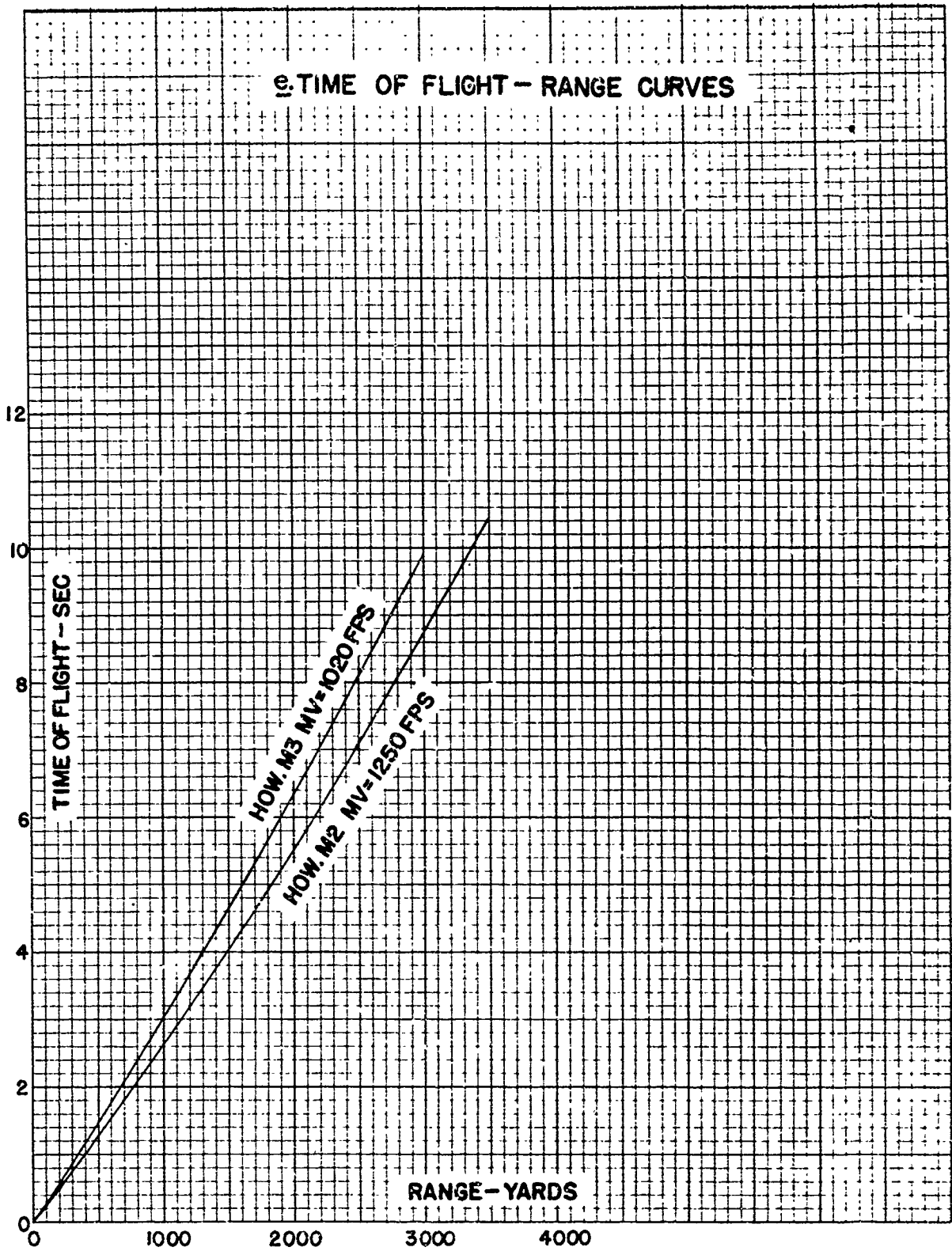

SECTION V
EFFECT DATA

Penetration - - - - - Paragraph
9

9. Penetration. The average penetration into homogeneous armor plate is 4.5 inches.

Ballistic Research Laboratories
Handbook of Ballistic and
Engineering Data for Ammunition,
No. 105-1-314

Ballistic Research Lab.
Aberdeen Proving Ground,
Maryland.
15 February 1949

BALLISTIC AND ENGINEERING DATA
for
Shell, Illuminating, 105-mm, M314
with
Fuze, TSQ, M54

<u>Section</u>	<u>Paragraphs</u>
I General -----	1
II Description -----	2 - 4
III Interior ballistic data -----	5
IV Exterior ballistic data -----	6 - 7
V Effect data -----	8

**SECTION I
GENERAL**

	<u>Paragraphs</u>
Purpose - - - - -	1

1. **Purpose.** The purpose of this number of the handbook is to furnish a concise collection of information regarding the shape, dynamics, ballistics and effects of the 105-mm Illuminating Shell M314 with the Time and Superquick Fuze M54. This information is collected from the drawings, reports, firing tables and firing records pertaining to this ammunition.

**SECTION II
DESCRIPTION**

	<u>Paragraph</u>
Drawings - - - - -	2
Dimensions - - - - -	3
Physical characteristics - - - - -	4

ALL DIMENSIONS IN CALIBERS
; CAL = 4.134"

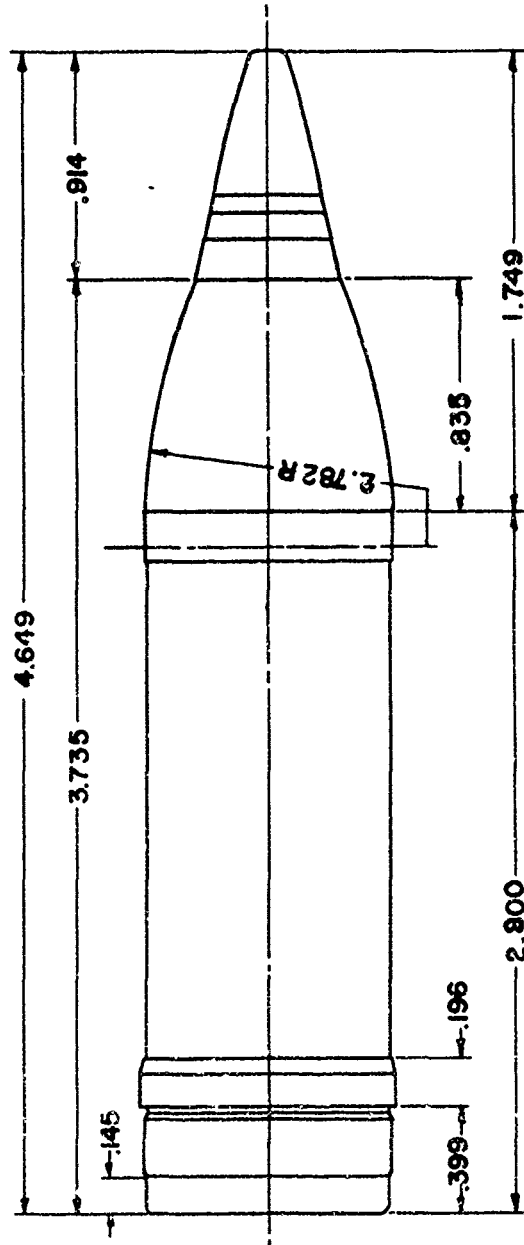

SHELL, ILLUMINATING, 105-MM, M314
FUZE, T SQ, M54

2. Drawings.

Shell: Metal parts assembly	75-4-128
Details	75-4-129
Fuze: Assembly	73-3-154

3. Dimensions.

Band: Width	0.196 cal
Distance from base	0.399 cal
Body: Length of base piece	0.145 cal
Length of cylindrical part	2.900 cal
Length of ogival part	0.835 cal
Radius of ogival arc	2.782 cal
Length of shell	3.735 cal
Fuze: Length (outside)	0.914 cal
Length of shell and fuze	4.649 cal
Length of ogive and fuze	1.749 cal

4. Physical characteristics.

Weight (standard)	38.60 lb
Base to center of gravity	1.180 cal
Axial moment of inertia	0.286 lb.ft ²
Transverse moment of inertia	1.416 lb.ft ²

**SECTION II
INTERIOR BALLISTIC DATA**

Theoretical yaw in bore - - - - - Paragraph
5

5. Theoretical yaw in bore.

Minimum	8 min
Maximum	15 min

SECTION IV
EXTERIOR BALLISTIC DATA

	<u>Paragraph</u>
Aerodynamic data - - - - -	6
Firing table data - - - - -	7

6. Aerodynamic data.

a. Drag. The following drag coefficients were computed from the ballistic coefficients tabulated in paragraph 6, which were determined by range firings.

<u>Velocity</u> <u>fps</u>	<u>K_D</u>
620	.0881
674	.0881
738	.0885
825	.0899
958	.0950
1158	.1829
1453	.1892

b. Stability.

Muzzle Velocity	1228 fps
Moment coefficient, K_M	1.37
Twist of rifling	1/20
Stability factor	3.60

7. Firing table data. FT 105-H-3 (C-11)

105-mm Howitzer M2A1 and M4. Twist of rifling: 1/20.

OCM items 28809 and 29657 recommended and approved standardization of the Illuminating Shell M314.

a. Form Factor and Ballistic Coefficient.

The following form factors and ballistic coefficients on the drag function $G_{6.1}$ were determined by range firings and are independent of elevation.

<u>Charge</u> <u>No.</u>	<u>MV</u> <u>fps</u>	<u>Form</u> <u>Factor</u>	<u>Ballistic</u> <u>Coefficient</u>
1	620	1.050	2.007
2	674	1.055	1.996
3	738	1.063	1.981
4	825	1.075	1.959
5	958	1.101	1.914
6	1158	1.135	1.856
7	1453	1.097	1.920

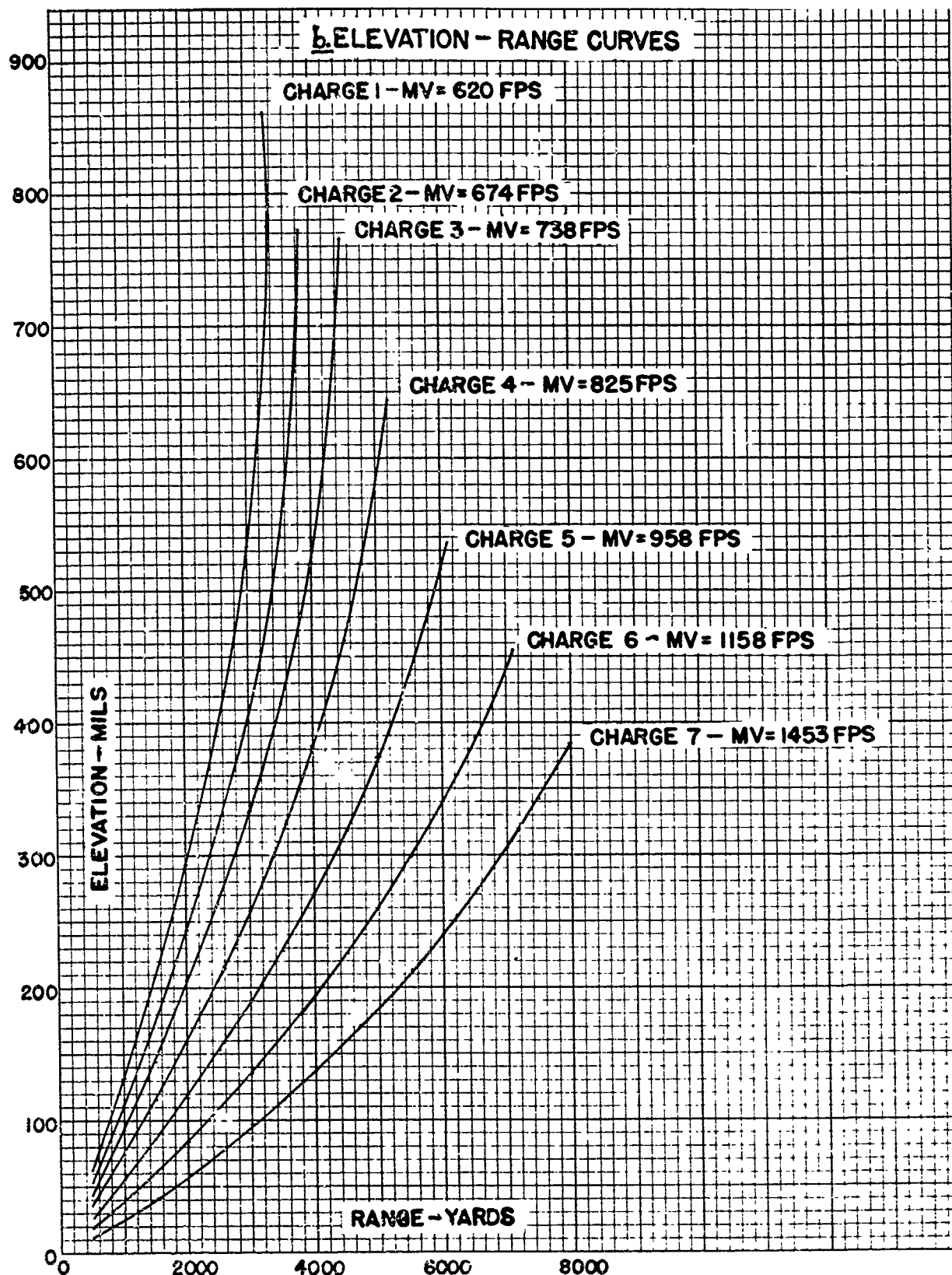

SECTION V
EFFECT DATA

Paragraph

Illumination - - - - - 8

8. **Illumination.** When the fuze functions, the candle and parachute are released. A few seconds later, the parachute opens and slowly lowers the candle to the ground. In the functioning tests of this ammunition, the candles burned from 38 to 57 seconds.